

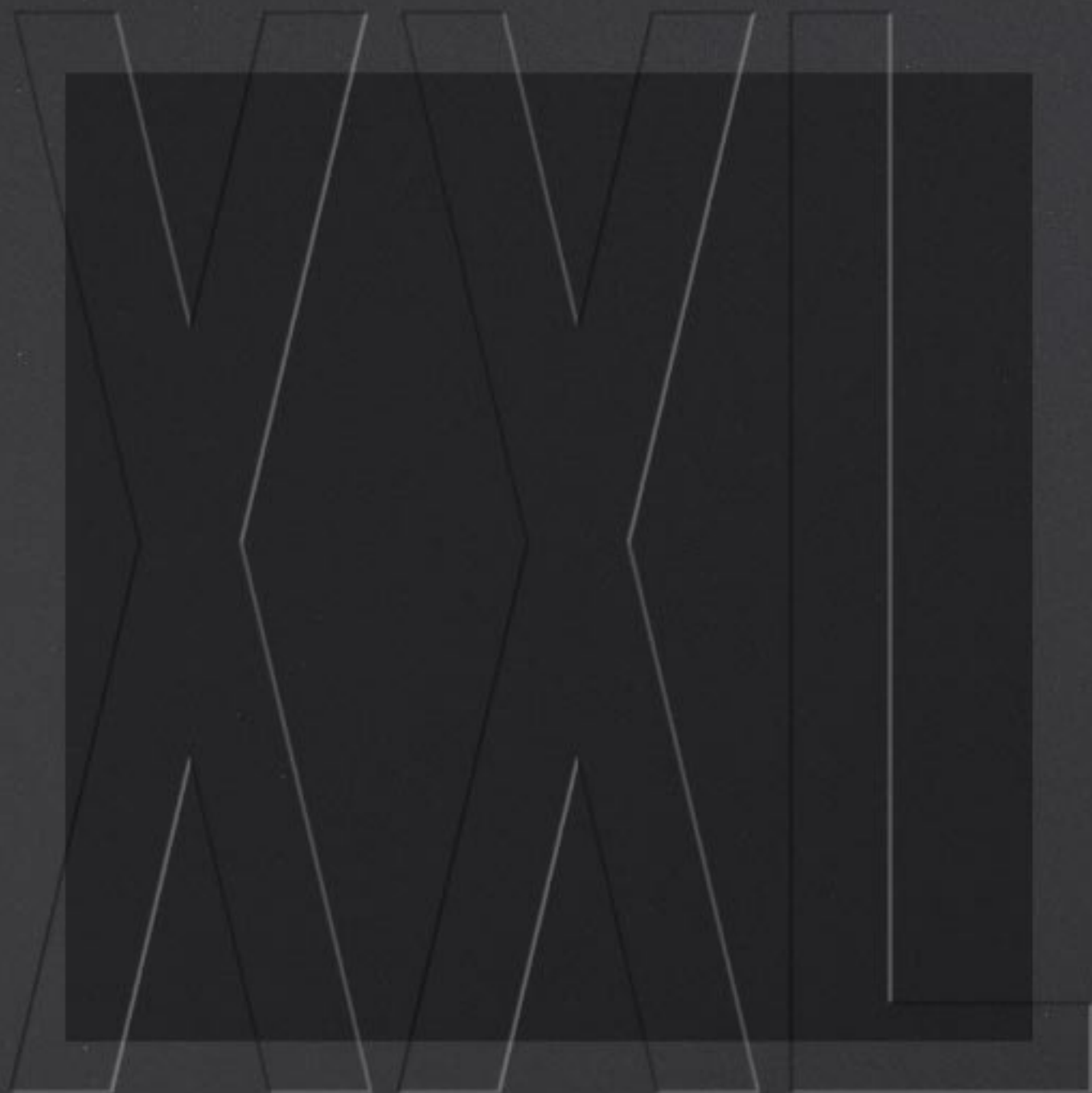

IB RUBINETTI



General catalogue / Catalogo generale / Catalogue général



IB RUBINETTI

WE ARE ITALIAN DESIGN CULTURE

ST STORY | STORIA | HISTOIRE

TR TECHNICAL REFERENCE | REFERENZE TECNICHE
RÉFÉRENCE TECHNIQUE

BH BATHROOM COLLECTION | COLLEZIONE BAGNO |
COLLEZIONE BAGNO

SW SHOWER COLLECTION | COLLEZIONE DOCCIA |
COLLEZIONE DOCCIA

KC KITCHEN COLLECTION | COLLEZIONE CUCINA |
COLLEZIONE CUCINA



ST



STORY
STORIA
HISTOIRE



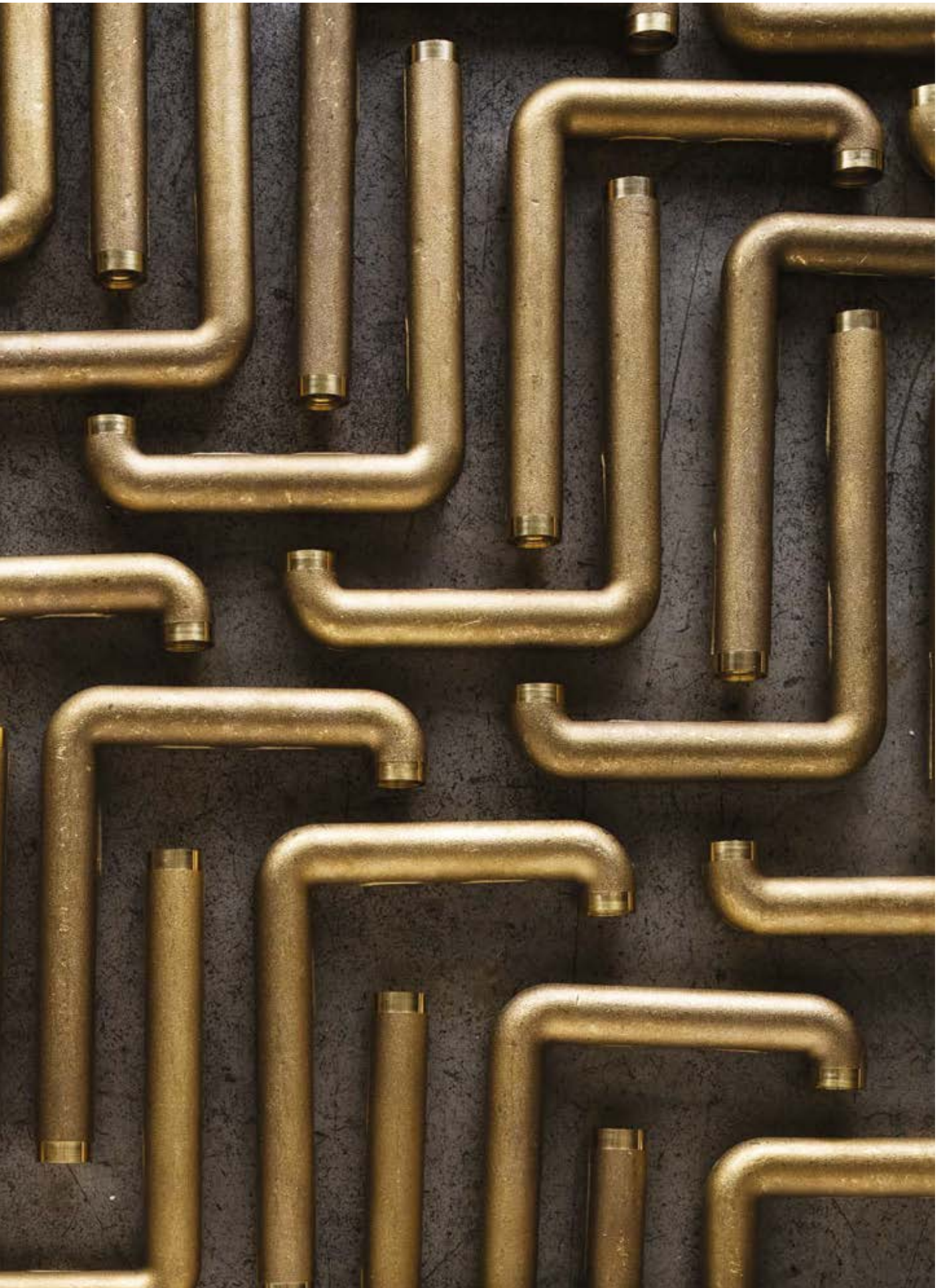

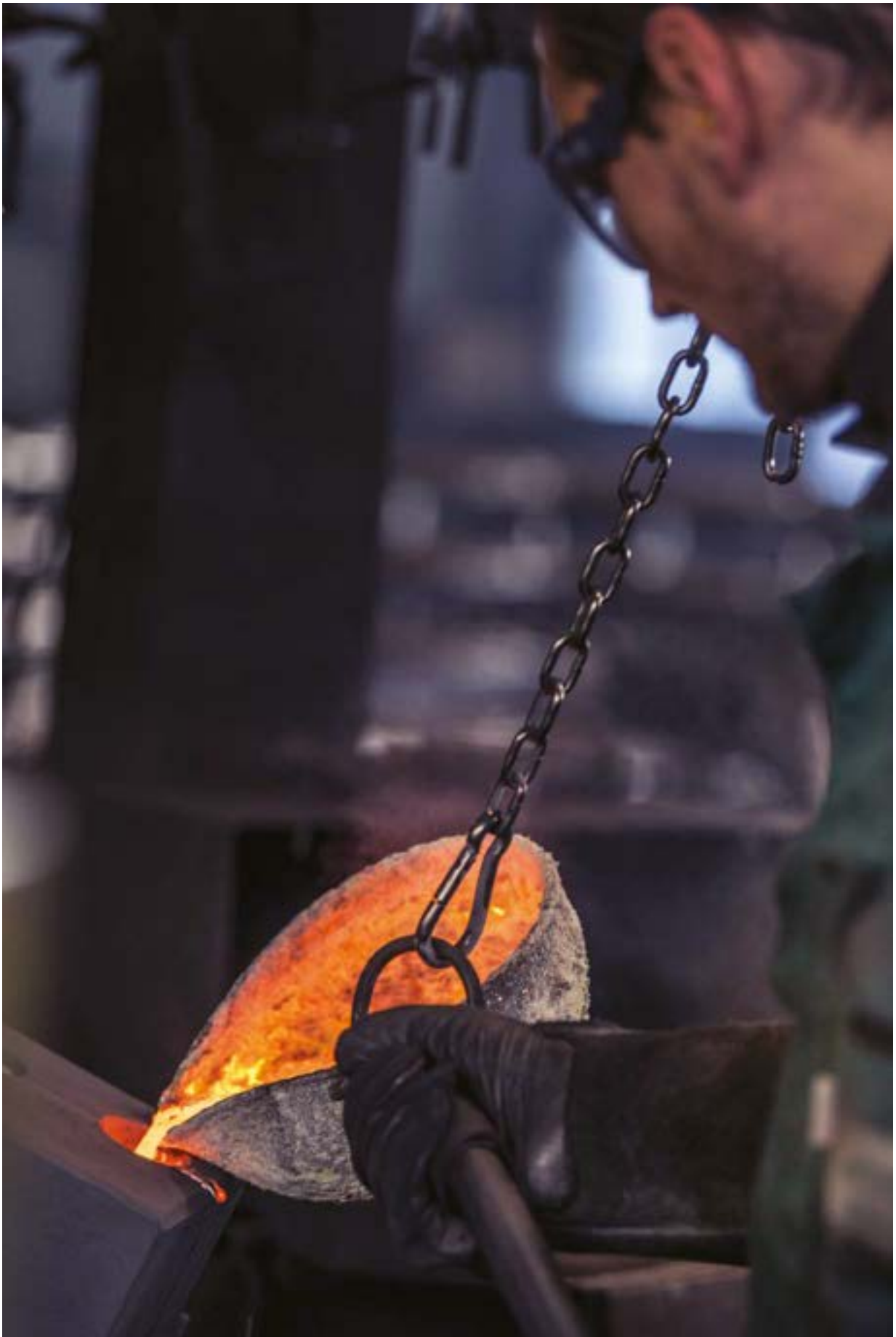



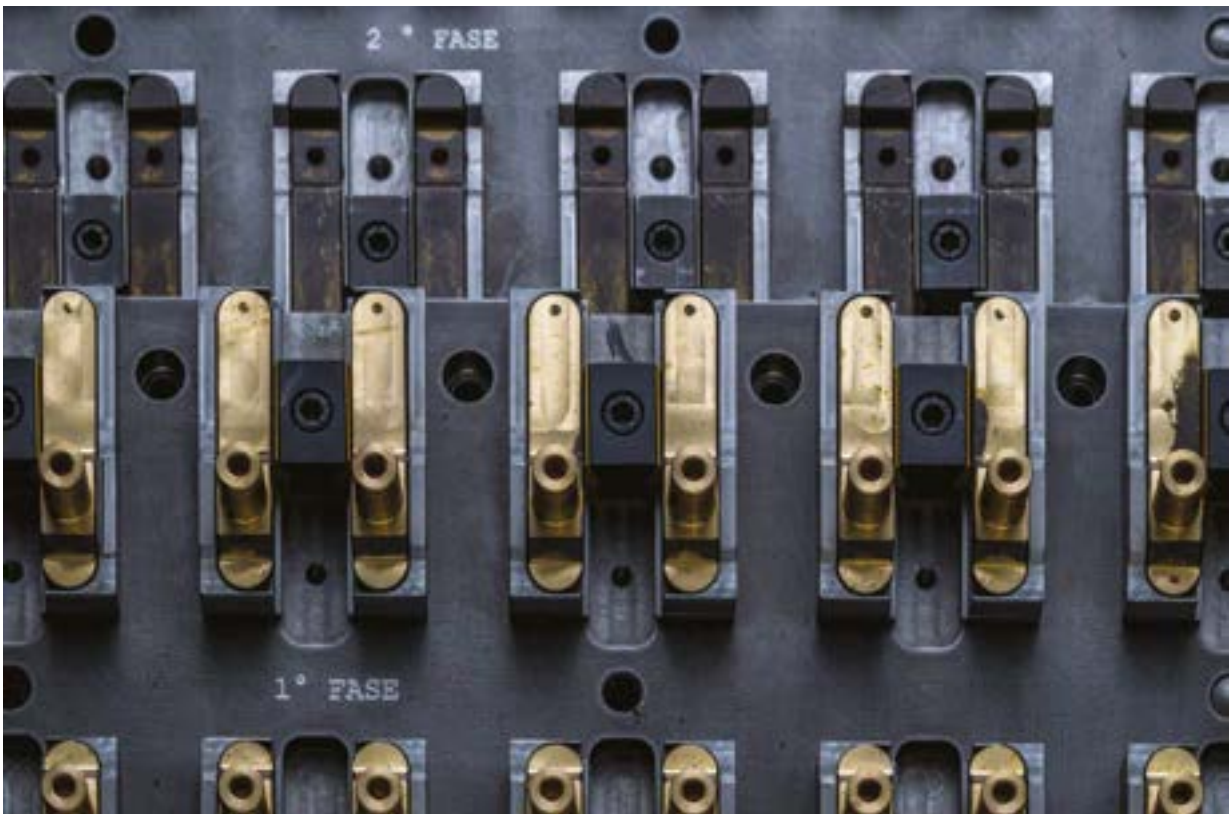



Water as a source of origin

The history of IB Rubinetti is rooted in a land of lakes and rivers, where the abundance of water has always been a crucial element for the socio-economical identity of the region. Brescia territory has always taken advantage of the wild waters of its rivers and of the placid surfaces of its lakes for its industrial and agricultural development.

Val Trompia has been one of the most active industrial centres in Italy since the beginning of the nineteenth century.

The town of Sarezzo, heart of the Val Trompia economic activity, is crossed by a source of life and abundance, River Mella, which flows from the peaks of Mount Maniva to the Po valley. Not far away, the River Oglio generates Lake Iseo flowing from Val Camonica, while Lake Garda originates from the dolomitic waters.

The influence that the territory has on IB Rubinetti's work is constant, and can also be found in the raw material selected, the brass. Residence to one of the most important national iron and steel industries,

L'acqua come origine

La storia di IB Rubinetti è radicata in una terra di laghi e di fiumi, in cui l'abbondanza dell'acqua è da sempre un fattore determinante per l'identità sociale ed economica della regione. Il territorio bresciano ha da sempre sfruttato le torrentizie acque dei suoi fiumi e le placide superfici dei suoi laghi per il proprio sviluppo industriale e agricolo.

La val Trompia era già all'inizio dell'Ottocento uno dei centri industriali più attivi d'Italia.

Il paese di Sarezzo, fulcro dell'attività economica della val Trompia, è attraversato da una fonte di vita e di abbondanza, il fiume Mella, che scorre dalle cime del monte Maniva fino alla pianura padana. Poco lontano, il fiume Oglio dalla Val Camonica genera il lago d'Iseo, mentre dalle acque dolomitiche ha origine il lago di Garda. L'influenza che il territorio ha sul lavoro di IB Rubinetti è costante, e la si ritrova anche nella materia prima lavorata, l'ottone. Sede di una delle più importanti industrie siderurgiche nazionali, che comprende





L'eau comme origine

L'histoire de IB Rubinetti est ancrée dans un territoire de lacs et de rivières, où l'abondance d'eau a toujours été un facteur déterminant pour l'identité sociale et économique de la région. La région de Brescia a depuis toujours exploité les eaux torrentielles de ses rivières et les placides surfaces de ses lacs pour son développement industriel et agricole.

La Val Trompia était
l'un des centres
industriels les plus
actifs d'Italie déjà au
début du XIXe siècle.

Le village de Sarezzo, cœur de l'activité économique de la Val Trompia, est traversé par une source de vie et d'abondance, la rivière Mella, qui coule du sommet du mont Maniva jusqu'à la vallée du Po. Un peu plus loin, la rivière Oglio, provenant de la Val Camonica, forme le lac d'Iseo, tandis que les eaux dolomitiques donnent origine au lac de Garde.

L'influence du territoire sur le travail d'IB Rubinetti est constante et se retrouve également dans la matière première traitée, le laiton. Siège de l'une des plus



ENG

which includes the entire iron processing cycle, Val Trompia has been one of the most active industrial centres in Italy since the beginning of the nineteenth century: the forges, with their fascinating hydraulic technology, exploited the bursting force of water flowing downstream to work this material, available in rich quantities in the whole territory. IB Rubinetti has managed to keep this ancient industrial tradition alive by working high quality brass. However, the tradition is not only the geographical one, but also the familiar one, transmitted from generation to generation.

IB Rubinetti was born in 1985 from Elio Bregoli's passion and high competence.

IB Rubinetti was born in 1985 from the passion and high competence of Elio Bregoli, president of the company. Built together with his wife Antonella, IB Rubinetti is enriched by their children's new ideas, enthusiasm and love for the profession. Andrea and Davide have recognized the value of tradition and have opened the business to international markets. However, the family is not only the one determined by blood ties, it is also the one we choose, the ones we love and the collaborative relationships that we build throughout a lifetime.

Being part of the IB world means being part of a family.



ITA

FRA



l'intero ciclo della lavorazione del ferro, la val Trompia era già all'inizio dell'Ottocento uno dei centri industriali più attivi d'Italia: i magli, con la loro affascinante tecnologia idraulica, sfruttavano la forza prorompente dell'acqua che scende verso valle per lavorare la materia prima di cui il territorio si mostrava ricco.

IB Rubinetti è riuscita a mantenere viva questa antica tradizione industriale, lavorando un ottone di alta qualità.

La tradizione non è tuttavia solo quella geografica, ma anche quella familiare, trasmessa di generazione in generazione.

IB Rubinetti nasce nel 1985 dalla passione e l'alta competenza di Elio Bregoli.

IB Rubinetti nasce nel 1985 dalla passione e l'alta competenza di Elio Bregoli, presidente dell'azienda. Fondata insieme alla moglie Antonella, IB Rubinetti si arricchisce grazie alle nuove idee, l'entusiasmo e l'amore per la professione, dei figli Andrea e Davide, che riconoscono il valore della tradizione e aprono l'azienda all'internazionalità.

La famiglia non è peraltro solo quella determinata dai legami di sangue, è anche quella che noi ci scegliamo, gli affetti e le relazioni collaborative che intessiamo nel corso di tutta una vita.

Essere parte del mondo IB significa far parte di una famiglia.



importantes industries sidérurgiques nationales, qui couvre le cycle entier du travail du fer, la Val Trompia était, déjà au début du XIXe siècle, l'un des centres industriels les plus actifs d'Italie: les marteaux hydrauliques, avec leur technologie fascinante, exploitaient la force irrépessible de l'eau qui descend vers la vallée pour travailler la matière première dont le territoire est riche. IB Rubinetti a réussi à maintenir cette ancienne tradition industrielle en travaillant un laiton de haute qualité. Cependant, la tradition n'est pas seulement celle géographique, mais aussi celle familiale, transmise de génération en

IB Rubinetti a été fondée en 1985 grâce à la passion et l'haute compétence d'Elio Bregoli.

génération. IB Rubinetti a été fondée en 1985 grâce à la passion et à l'haute compétence d'Elio Bregoli, président de la société. Fondée avec son épouse Antonella, IB Rubinetti s'enrichit grâce aux nouvelles idées, à l'enthousiasme et à l'amour du métier des fils Andrea et Davide, qui reconnaissent la valeur de la tradition et ouvrent l'entreprise à l'internationalité. Toutefois, la famille n'est pas seulement déterminée par les liens de sang, elle est aussi celle choisie, les affections et les collaborations que nous tissons tout au long de notre vie.

Faire partie du monde IB, c'est faire partie d'une famille.

ENG

This is why the IB family grows to include all workers and collaborators who, over the years, have engaged, together with the Bregoli family, this journey in an industrial production based on local traditions.

IB Rubinetti products are the outcome of the most advanced technological innovations, with a particular care for details and a technical and aesthetic quality.

IB Rubinetti's products do not emerge just from tradition, but also from the encounter with the most advanced technological innovations and from an attention to details and to technical and aesthetic qualities without equal.

The most innovative element is, without any doubt, the raw material processing method. The processed brass alloy is free of lead and zinc, and therefore hypoallergenic and purified by the main pollutants. Another revolutionary element is the desire to internalize the whole production chain: IB Rubinetti is involved in the manufacturing and the production of every single component, from the raw material to the most particular finishes.

An innovation that doesn't stop at the content, but also concerns the form. First in history, IB Rubinetti has become, since the beginning of the 2000s, a constant sponsor and collaborator in the field of Italian design, combining functionality of form with innovation in aesthetics.



ITA

FRA



È così che la famiglia IB si allarga e racchiude tutti i lavoratori e i collaboratori che, nel corso degli anni, hanno affrontato insieme alla famiglia Bregoli questo viaggio nella produzione industriale fondata sulla tradizione locale.

I prodotti di IB sono il frutto delle più avanzate innovazioni tecnologiche con un'attenzione al dettaglio e alla qualità tecnica ed estetica.



I prodotti di IB Rubinetti non sono solo frutto della tradizione, ma anche dell'incontro con le più avanzate innovazioni tecnologiche, e con un'attenzione al dettaglio e alla qualità tecnica ed estetica senza pari. Gli elementi innovativi si ritrovano innanzitutto nel metodo di lavorazione della materia prima. La lega d'ottone prodotta è priva di piombo e zinco, e dunque anallergica e purificata dai principali agenti contaminanti. Un ulteriore elemento rivoluzionario è la volontà di internalizzare l'intera catena produttiva: IB Rubinetti si occupa della lavorazione e produzione di ogni singolo componente dei suoi articoli da bagno, dalla materia prima fino alle più particolari finiture. Un'innovazione che non si ferma al contenuto, ma che riguarda anche la forma. Primo nella storia, IB Rubinetti si fa, fin dall'inizio degli anni Duemila, sponsor e collaboratore costante del mondo del design italiano, unendo funzionalità della forma a innovazione estetica.

C'est ainsi que la famille IB s'élargit en incluant tous les travailleurs et collaborateurs qui, au fil des années, ont affronté, à coté de la famille Bregoli, ce voyage dans une production industrielle fondée sur la tradition locale.

Les produits IB Rubinetti sont le résultat des innovations technologiques les plus avancées, soucieuses du détail et de la qualité technique et esthétique.

Les produits IB Rubinetti ne sont pas seulement le fruit de la tradition, mais aussi de la rencontre avec les innovations technologiques les plus avancées, soucieuses du détail et d'une qualité technique et esthétique sans égal. Les éléments innovants se trouvent avant tout dans la méthode de fabrication de la matière première. L'alliage de laiton produite est sans plomb ou zinc et est donc anallergique et purifié des principaux agents contaminants. Un ultérieur élément révolutionnaire est la volonté d'internaliser l'entière chaîne de production: IB Rubinetti s'occupe de la transformation et production de chaque composant pour ses articles, à partir de la matière première jusqu'aux finitions les plus particulières. Une innovation qui ne se limite pas au contenu, mais qui concerne également la forme. Première dans l'histoire, IB Rubinetti est devenue, à partir du début des années 2000, sponsor et collaborateur constant du design italien, combinant fonctionnalité et innovation esthétique.

IB Rubinetti has become a reference point for architects and designers.

Crossing all boundaries, IB deals with the most intriguing exponents of Italian excellence, opening up to numerous collaborations, driven by its sincere curiosity and genuine desire to learn from different cultures and fields. This is why IB Rubinetti has become an unquestionable and indispensable reference point for architects and designers like Maurizio Duranti, Giulio Iacchetti, Lorenzo Damiani, Remi Theberge, Marco Acerbis, Nadia Monigliardi, Antonio Gardoni, Federico Castelli and many more. The goal is always to develop high-design projects, innovative and daring in their aesthetics, but always attentive to the high functionality of the product.

The goal is always to develop high-design projects.

Therefore, our enterprise chooses the path of a design categorically made in Italy, as the only possible solution to create a future that learns from history and progresses towards new horizons.

A formula, this synthesis between tradition and innovation, functionality and aesthetic, which has also earned IB Rubinetti worldwide development and collaborations with many companies outside the national

IB Rubinetti è diventato un punto di riferimento per architetti e designer.

Valicando tutti i confini, IB si confronta con le più interessanti rappresentanze dell'eccellenza italiana aprendosi a numerose collaborazioni, spinti dalla sincera curiosità e la genuina voglia di imparare da culture e saperi differenti.

Ecco perché IB Rubinetti è diventato un punto di riferimento indiscusso e imprescindibile per architetti e designer del calibro di Maurizio Duranti, Giulio Iacchetti, Lorenzo Damiani, Remi Theberge, Marco Acerbis, Nadia Monigliardi, Antonio Gardoni, Federico Castelli e molti altri. L'obiettivo è sempre quello di sviluppare progetti di alto design, innovativi e intraprendenti nella loro estetica, ma sempre con un occhio di riguardo all'alta funzionalità del prodotto.

L'obiettivo è sempre quello di sviluppare progetti di alto design.

L'azienda sceglie così la via del design, categoricamente made in Italy, come unica soluzione possibile al fine di creare un futuro che impari dalla storia e progredisca verso nuovi orizzonti.

Una formula, questa sintesi tra tradizione e innovazione, funzionalità e qualità estetica, che è valsa a IB Rubinetti anche l'espansione globale e la collaborazione con molte realtà al di fuori dei confini nazionali,





IB Rubinetti est devenu un point de référence pour architectes et designers.

Franchissant toutes les frontières, IB se mesure avec les plus intéressants représentants de l'excellence italienne et s'ouvre à de nombreuses collaborations, animée par l'authentique curiosité et le désir sincère d'apprendre par les différentes cultures et domaines. Voilà pourquoi IB Rubinetti est devenue un point de référence incontesté et indispensable pour des architectes et designers comme Maurizio Duranti, Giulio Iacchetti, Lorenzo Damiani, Remi Theberge, Marco Acerbis, Nadia Monigliardi, Antonio Gardoni, Federico Castelli et bien d'autres. L'objectif est toujours de développer des projets de haut design, innovants et entreprenants de leur esthétique, mais toujours attentifs à l'haute fonctionnalité du produit.

Le but est toujours de développer des projets de haut design.

L'entreprise choisit ainsi la voie du design, catégoriquement made in Italy, comme la seule solution possible pour créer un avenir qui tire parti de l'histoire et progresse vers de nouveaux horizons.

Une formule, cette synthèse entre tradition et innovation, fonctionnalité et qualité esthétique, qui a même valu à IB Rubinetti une expansion mondiale et une collaboration avec de nombreuses



ENG

borders, opening to the international only to underline more the intrinsic value of its product.

Operative in sixty-four countries and over five continents, the IB brand has become the ambassador of Italian design production worldwide. Learning from other cultures and suiting different economies, but always maintaining the best quality standards that Italy can offer, IB Rubinetti means to remain consistent with its identity and tradition, but also to confront and please every market needs and desires.

Operative in sixty-four countries and over five continents, the IB brand becomes the ambassador of Italian design worldwide.

If it is true that water is a source of life and renovation, this statement has never been so true for an industrial production whose trademark and productive philosophy reflects this uninterrupted flow between tradition and innovation.



MACAO
VENETIAN HOTEL - CHINA



SANTA TERESA DI GALLURA
LA COLUCCIA - ITALY



NEW YORK
PARK PLACE - USA



ITA



in un'apertura all'internazionalità che non fa che sottolineare il valore intrinseco del suo prodotto.

Presente in sessantaquattro paesi e in cinque continenti, il marchio IB si fa ambasciatore della produzione italiana di design in tutto il mondo. Imparando da altre culture e adattandosi a economie differenti, ma mantenendo sempre il migliore standard qualitativo che l'Italia possa offrire, IB Rubinetti si ripropone di rimanere sempre coerente alla sua identità e tradizione, ma anche di affrontare e soddisfare le necessità e i desideri di ogni mercato.

Presente in sessantaquattro paesi e in cinque continenti, il marchio IB si fa ambasciatore del design italiano in tutto il mondo.

Se è vero che l'acqua è fonte di vita e di rinnovamento, questa affermazione non è mai stata così vera per una produzione industriale che del flusso continuo tra tradizione e innovazione ha fatto il suo marchio di fabbrica e la sua filosofia di produzione.



FRA

entreprises hors des frontières nationales, dans une ouverture à l'internationalité ne fait que souligner la valeur intrinsèque de son produit. Présente dans soixante-quatre pays et sur cinq continents, la marque IB devient ambassadrice de la production et du design italiens dans le monde entier. Apprenant des autres cultures et s'adaptant aux différentes économies, mais toujours en maintenant les meilleurs standards de qualité que l'Italie peut offrir, IB Rubinetti compte de rester cohérent à son identité et à ses traditions, tout en faisant face aux besoins et aux désirs de chaque marché.

Présente dans soixante-quatre pays et sur cinq continents, la marque IB devient ambassadrice de la production et du design italiens dans le monde entier.

S'il est vrai que l'eau est une source de vie et de renouveau, cette affirmation n'a jamais été si vraie que pour une production industrielle qui a construit sa marque et sa philosophie productive sur le flux continu entra tradition et innovation.



SCIACCA
VERDURA GOLF SPA RESORT - ITALY

20°

EUROPE

30°



PINZOLO-TRENTO
LEFAY RESORT DOLOMITI - ITALY



MADRID
THE PAVILLIONS HOTEL - SPAIN



LUGANO
THE VIEW - SWITZLAND



BARCELONA
HOTEL JAZZ - SPAIN



BERGAMO
RELAIS S. LORENZO - ITALY



IBIZA
DESTINO RESORT - SPAIN



TEL-AVIV
THE NISHI - ISRAEL



DUBAI
FAIRMONT HOTEL - MIDDLE EAST



DUBAI
AL BANDAR ROTANA - MIDDLE EAST



DUBAI
AL BARARI VILLAS - MIDDLE EAST

60°

ASIA

120°



TOKYO
PARK HYATT HOTEL - JAPAN

130°

ASIA

170°



BUSAN
PARK HYATT HOTEL - SOUTH KOREA



SINGAPORE
MOVENPICK HOTEL - CHINA



SHENZHEN
INTERCONTINENTAL HOTEL - CHINA



BALI
KOMUNE RESORT AND BEACH CLUB - INDONESIA

-170°

USA

-80°



TORONTO
BISHA HOTEL BY WALLMAN ARCHITECTS WITH LENNY KRAVITZ - CANADA



MONTREAL
LE MERIDIEN VERSAILLES - CANADA



RECIFE
SHERATON HOTEL - BRASILE



TORONTO
MASSEY TOWER - CANADA



MAUI
ANDAZ MAUI - HAWAI

-20°

AFRICA

0°



DAKAR
ENCORE - SENEGAL



TANZANIA
FARU FARU LODGE - AFRICA



DAKAR
TAROU - SENEGAL



CAPE TOWN
FARU FARU LODGE - AFRICA

People before designers

Persone prima di designers.
Les gens avant les designers.

Acerbis



Biography

Graduated in architecture at the Milan Polytechnic in 1998, he moved immediately to London, where he worked for Lord Norman Foster until 2004, when he inaugurated his agency in Italy. Always looking for new technologies and subjects, Marco Acerbis designs avant-garde projects, always focused on environmental sustainability. Among the most important designs, we'll mention the Vertigo lamp, included in the permanent collection of the Vitra Design Museum, and two Italian buildings, certified Class A, Xellox Energy Lab and Polins.

Biografia

Laureato in architettura al Politecnico di Milano nel 1998, si trasferisce subito a Londra, dove lavora presso Lord Norman Foster fino al 2004, anno d'inaugurazione del suo studio in Italia. Alla continua ricerca di nuove tecnologie e soggetti, Marco Acerbis idea design d'avanguardia, sempre attenti alla sostenibilità ambientale. Tra i progetti più importanti, ricordiamo la lampada Vertigo, inclusa nella collezione permanente del Vitra Design Museum, e i due edifici italiani, certificati Classe A, Xellox Energy Lab e Polins.

Biographie

Diplômé en architecture à l'École polytechnique de Milan en 1998, il s'installe immédiatement à Londres, où il travaille chez Lord Norman Foster jusqu'en 2004, année de l'inauguration de son agence en Italie. Toujours à la recherche de nouvelles technologies et de nouveaux sujets, Marco Acerbis conçoit des designs avant-gardistes et toujours attentifs à la durabilité environnementale. Parmi les projets les plus importants, citons la lampe Vertigo, figurant dans la collection permanente du Vitra Design Museum, et les deux bâtiments italiens, certifiés de classe A, Xellox Energy Lab et Polins.

Castelli



Biography

Graduated in Industrial Design, Federico Castelli began his profession in 2006 by collaborating with several design studios. In 2016 he founded his homonymous agency, specializing in numerous branches of design, from product to graphic design, from interior design to installations, claiming various collaborations with IB Rubinetti, Max Mara, Innova energie. At the centre of each project is the aesthetic element, not as an absolute ideal, but rather as the result of a dedicated and consistent work.

Biografia

Formatosi in Industrial Design, Federico Castelli nel 2006 inizia la professione collaborando con diversi studi di design. Nel 2016 fonda il suo omonimo studio specializzato nelle molteplici discipline del design, dal prodotto alla grafica, dagli interni agli allestimenti, vantando collaborazioni con IB Rubinetti, Max Mara, Innova energie. Al centro di ogni suo progetto è situato l'elemento estetico, non come un ideale assoluto, ma piuttosto come il risultato di uno lavoro assiduo e coerente.

Biographie

Diplômé en design industriel, Federico Castelli entprend sa profession en 2006, en collaborant avec plusieurs agences de design. En 2016, il fonde son agence homonyme spécialisée dans les multiples disciplines du design, à partir du design de produit jusqu'à la graphique, du design d'intérieurs aux installations, et il collabore avec IB Rubinetti, Max Mara et Innova energie. L'élément esthétique est au centre de chaque projet, non pas en tant qu'idéal absolu, mais plutôt comme le résultat d'un travail constant et cohérent.

Damiani



Biography

Born in 1972 and graduated in architecture at the Milan Polytechnic, Lorenzo Damiani has always been involved in furniture and product design, collaborating with companies like Illy Caffè, IB Rubinetti and Lavazza. He was a guest of the Triennale Design Museum with three solo exhibitions, the first in 2009 edited by M. Romanelli, the followings in 2012 by G. Castiglioni and S. Annicchiarico. In the sixth edition of 2013, the Triennale entrusted him with the planning of an exhibition dedicated to the Castiglioni brothers.

Biografia

Classe 1972, laureatosi in architettura al Politecnico di Milano, Lorenzo Damiani si occupa da sempre di furniture and product design, collaborando con aziende del calibro di Illy Caffè, IB Rubinetti e Lavazza. È stato ospite del Triennale Design Museum con tre mostre personali, la prima nel 2009 curata da M. Romanelli, le successive nel 2012 a cura di G. Castiglioni e S. Annicchiarico. La Triennale gli ha affidato, nella sesta edizione del 2013, l'allestimento della mostra dedicata ai fratelli Castiglioni.

Biographie

Né en 1972, diplômé en architecture à l'École polytechnique de Milan, Lorenzo Damiani s'est toujours occupé de furniture and product design, en collaborant avec des entreprises comme Illy Caffè, IB Rubinetti et Lavazza. Il a figuré dans le Triennale Design Museum avec trois expositions personnelles, la première en 2009 organisée par M. Romanelli, les suivantes en 2012 par G. Castiglioni et S. Annicchiarico. Lors de la sixième édition de 2013, la Triennale lui a confié l'organisation de l'exposition dédiée aux frères Castiglioni.

Duranti



Biography

Born in Florence in 1949, Maurizio Duranti graduated in Architecture at Genoa in 1976, and in this city he opened his first agency until 1987, when he moved to Milan. He works as an architect and, above all, as an Industrial designer, working for numerous companies in the household sector. Many of his designed products are included in international museums collections. He is a ten times winner of the Chicago Good Design Award and he was granted the honourable mention at the Compasso d'Oro in Milan.

Biografia

Nato a Firenze nel 1949, Maurizio Duranti si laurea in Architettura a Genova nel 1976, e in questa città apre il suo primo studio fino al 1987, anno in cui si trasferisce a Milano. Si occupa di architettura, ma soprattutto di Industrial Design, progettando per numerose aziende in tutti i settori del casalingo. Numerosi prodotti da lui disegnati sono presenti nelle collezioni di musei internazionali. È dieci volte vincitore del GOOD DESIGN AWARD di Chicago ed è stato insignito della Segnalazione d'Onore al Compasso d'Oro di Milano.

Biographie

Né à Florence en 1949, Maurizio Duranti obtient son diplôme d'architecture à Gênes en 1976. Il ouvre sa première agence dans cette ville jusqu'en 1987, date à laquelle il s'installe à Milan. Il s'occupe d'architecture, mais surtout de design industriel, planifiant pour de nombreuses entreprises dans tous les secteurs ménagers. De nombreux produits par lui conçus figurent dans les collections des musées internationaux. Il a remporté dix fois le Good Design Award de Chicago et il a reçu la Recommandation d'Honneur au Compasso d'Oro de Milan.

Gardoni



Biography

Born in 1972 in Brescia and graduated in Architecture in Venice in 1997, after many work experiences abroad, he created his architectural agency AG Studio in 2004, where he is specialized in interior architecture, but also in graphic and product design, communication and art direction. Its customers include Redbull, Nike, Google, Levi's, IB Rubinetti and Lever Faberger. He is also the creator of the Bogue-Profumo brand, for the design, production and distribution of artistic perfumes.

Biografia

Nato nel 1972 a Brescia e laureatosi in Architettura a Venezia nel 1997, dopo numerose esperienze di lavoro all'estero, crea nel 2004 lo studio di architettura AG Studio, dove si occupa di architettura degli interni, ma anche di design grafico e di prodotto, comunicazione e art direction. Tra i suoi clienti si enumerano Redbull, Nike, Google, Levi's, IB Rubinetti e Lever Faberger. È anche il creatore del marchio Bogue-Profumo, per l'ideazione, la produzione e la distribuzione di profumi artistici.

Biographie

Né en 1972 à Brescia et diplômé en architecture à Venise en 1997, après de nombreuses expériences de travail à l'étranger, il crée l'agence d'architecture AG Studio en 2004, où il s'occupe d'architecture et d'interior design, mais également du design graphique et de produit, de communication et de direction artistique. Parmi ses clients figurent Redbull, Nike, Google, Levi's, IB Rubinetti et Lever Faberger. Il est également le créateur de la marque Bogue-Profumo, spécialisée dans la conception, la production et la distribution de parfums artistiques.

Iacchetti



Biography

Industrial designer since 1992, Giulio Iacchetti works with well-known national brands, including Alessi, Fontana Arte and Pandora design. Acknowledged for his ability to define new object types, his design research earned him multiple recognitions. Granted two Compasso d'Oro Awards in 2001 and 2014, he was also the recipient of the 2009 Innovation Awards and, in the same year, was honoured by the Milan Triennale with a solo exhibition entitled "Disobedient Objects".

Biografia

Industrial designer fin dal 1992, Giulio Iacchetti collabora con noti marchi nazionali, tra cui Alessi, Fontana Arte e Pandora design. Riconosciuto per la sua capacità di definire nuove tipologie oggettuali, la ricerca progettuale gli è valsa numerosi premi. Insignito per due volte del Compasso d'Oro, nel 2001 e nel 2014, ottiene nel 2009 il Premio dei Premi per l'innovazione e, nello stesso anno, è onorato dalla Triennale di Milano, che ospita una sua mostra personale intitolata "Objetti disobbedienti".

Biographie

Designer industriel dès 1992, Giulio Iacchetti collabore avec de grandes marques nationales, notamment Alessi, Fontana Arte et Pandora Design. Reconnu pour sa capacité de définir de nouveaux types d'objets, la recherche lui a valu de nombreux prix. Décoré de deux prix Compasso d'Oro en 2001 et 2014, il a remporté le Prix des Prix pour l'innovation en 2009 et a été honoré la même année par la Triennale de Milan, qui a accueilli une exposition personnelle intitulée "Objets désobéissants".

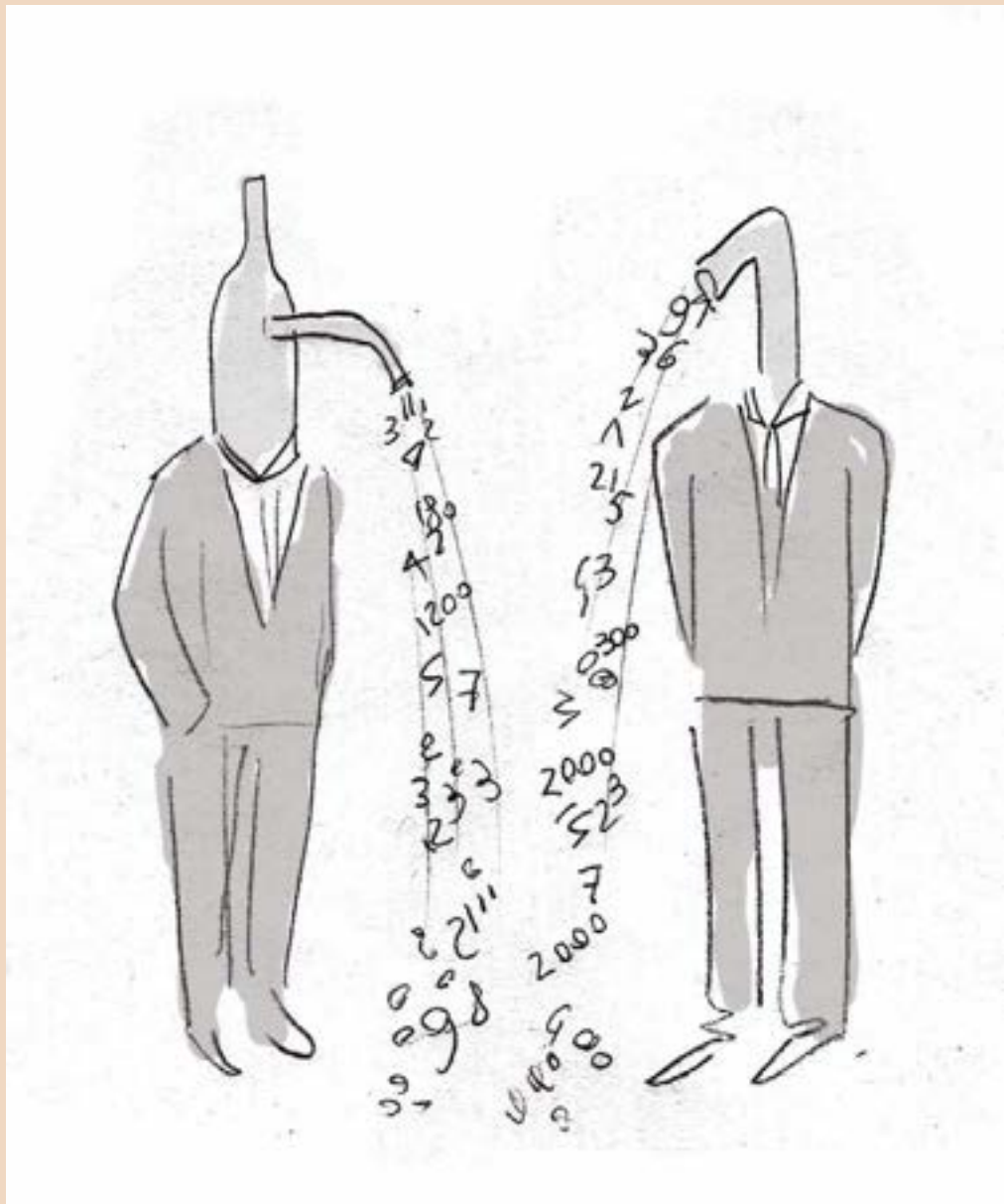

SKETCH BY GIULIO IACCHETTI

IT'S NOT
ABOUT IDEAS.
IT'S MAKING
IDEAS HAPPEN.

TR

TECHINICAL REFERENCE
REFERENZE TECNICHE
REFERNCE TEQUINQUE

From the idea to the product.

The design and manufacturing processes of IB Rubinetti products take place entirely within the company: from design to engineering, from plating to assembly, each step is performed under the watchful eye and capable hands of our enterprise.

Il percorso di progettazione e fabbricazione dei prodotti IB si svolge integralmente all'interno dell'azienda: dal design all'ingegnerizzazione, dalla cromatura fino all'assemblaggio, ogni passaggio viene svolto sotto l'occhio attento e le mani esperte dei nostri operatori.

Le parcours de conception et de fabrication des produits IB Rubinetti se déroule entièrement à l'intérieur de l'entreprise: du design à l'ingénierie, du chromage à l'assemblage, chaque étape est réalisée sous les yeux vigilants et les mains expertes de notre société.

Our products are systematically submitted to a reasoned series of six specific tests, in order to assess and evaluate the high quality of our offer.

I nostri prodotti sono sistematicamente sottoposti a una serie ragionata di sei test specifici, volti a collaudare e valutare l'alta qualità della nostra offerta.

Nos produits sont systématiquement soumis à une série raisonnée de six tests spécifiques, visant à tester et évaluer la qualité élevée de notre offre.

- (A) Dimensional test**
- (B) Surface check**
- (C) Surface test**
- (D) Pressure test for bodies**
- (E) Pressure test**
- **Open cartridge**
- **Closed cartridge**
- (F) Cleaning**

FACTORY CERTIFICATE

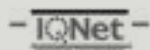

PRODUCT CERTIFICATE



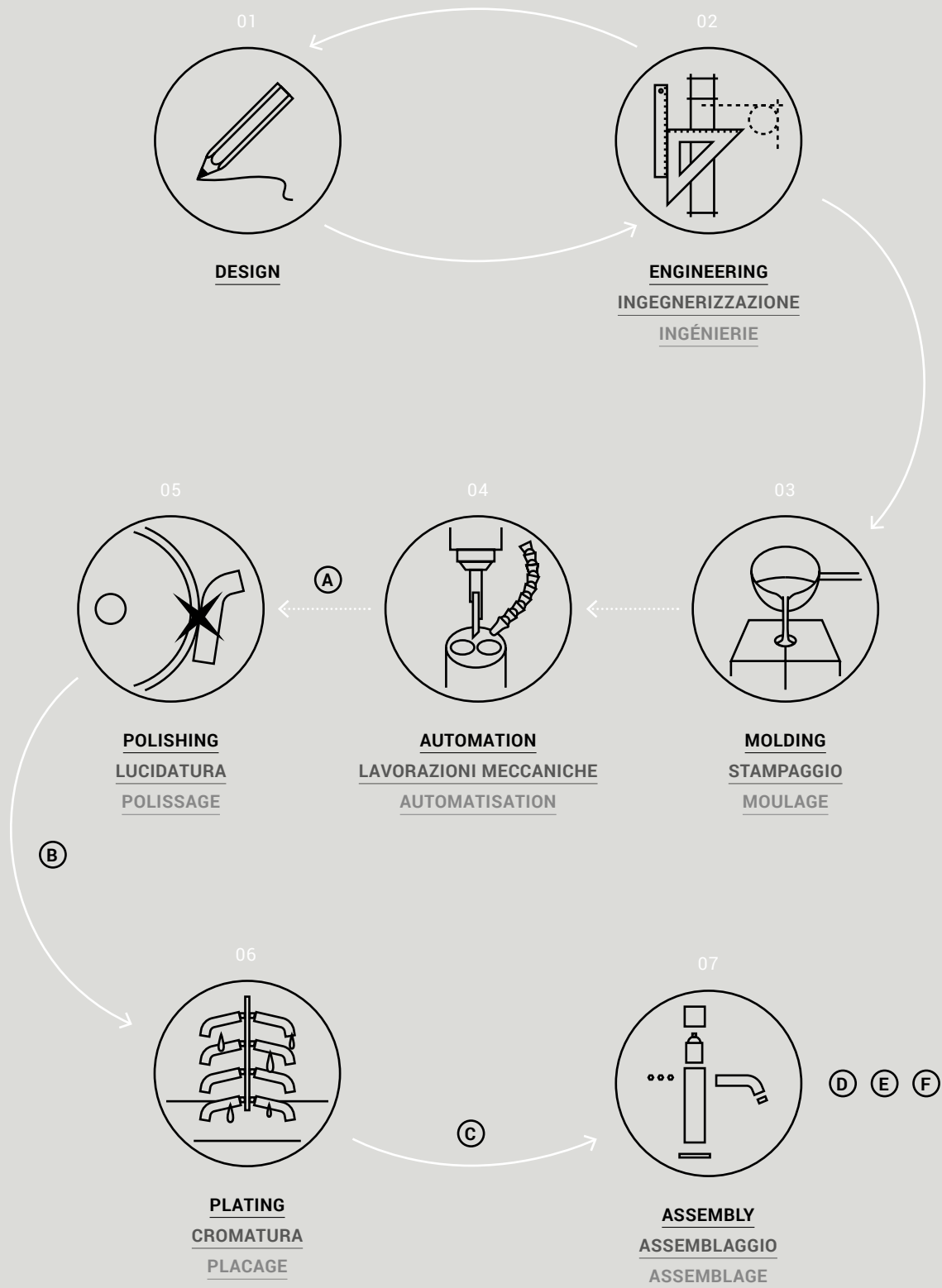

Material

IB Rubinetti uses all its expertise to promote innovation and customer care, starting from the choice of the raw material, a particular alloy of lead and zinc-free brass, which guarantees hypoallergenic and eco-friendly products.

IB Rubinetti mette tutta la sua esperienza al servizio dell'innovazione e della cura del cliente, a partire dalla scelta della materia prima, una particolare lega d'ottone priva di zinco e piombo che assicura un prodotto anallergico ed ecofriendly.

IB Rubinetti met toute son expérience au service de l'innovation et du service à la clientèle, à partir du choix de la matière première, un alliage particulier de laiton, sans zinc ou plomb, qui assure un produit anallergique et écologique.



(A) Finishes plating
Cromatura
Chromage

(B) Solid brass
Ottone
Laiton





LEAD FREE

We use only lead-free brass.
 Noi usiamo solo ottone senza piombo.
 Nous n'utilisons que du laiton sans Plomb.



ZINC FREE

We use only zinc-free brass.
 Noi usiamo solo zinco senza piombo.
 Nous n'utilisons que du laiton sans zinc.



WARRANTY

All IB Rubinetti products have a 10-years warranty.
 Tutti i prodotti IB Rubinetti godono di 10 anni di garanzia.
 Tous les produits IB ont une garantie de 10 ans.



ORIGIN

We only use materials from Europe.
 Noi usiamo solo materiale proveniente dall'Europa.
 Nous n'utilisons que des matériaux d'Europe.



CERTIFICATION

We comply with recognized world standards such as IAPMO, SITAC, CISQ, ACS.
 Rispettiamo gli standard di qualità più alti al mondo come IAPMO, SITAC, CISQ, ACS.
 Nous nous conformons à des standards mondialment reconnus tels IAPMO, SITAC, CISQ, ACS.



ENVIRONMENT

The production cycle respects the highest environmental standards.
 Il ciclo produttivo rispetta i più alti standard ambientali.
 Notre cycle de production respecte des standards environnementaux des plus hauts niveaux.

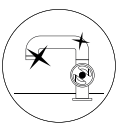

FINISHES

16 different finishes available.
 16 differenti finiture disponibili.
 16 différentes finitions disponible.



Chrome
 Chromo
 Chrome

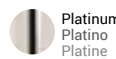

Platinum
 Platino
 Platine

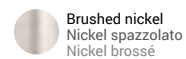

Brushed nickel
 Nickel spazzolato
 Nickel brossé

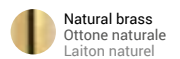

Natural brass
 Ottone naturale
 Laiton naturel



Matt white
 Bianco opaco
 Blanc mat



Matt black
 Nero opaco
 Noir mat

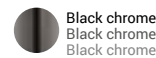

Black chrome
 Black chrome
 Black chrome

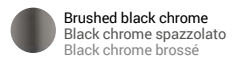

Brushed black chrome
 Black chrome spazzolato
 Black chrome brossé

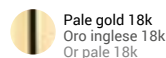

Pale gold 18k
 Oro inglese 18k
 Or pale 18k



Brushed pale gold 18k
 Oro inglese spazzolato 18k
 Or pale brossé 18k

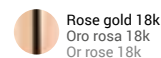

Rose gold 18k
 Oro rosa 18k
 Or rose 18k

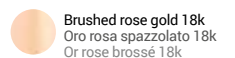

Brushed rose gold 18k
 Oro rosa spazzolato 18k
 Or rose brossé 18k



Gold 22k
 Oro 22k
 Or 22k

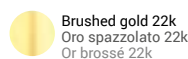

Brushed gold 22k
 Oro spazzolato 22k
 Or brossé 22k



Antique copper
 Rame antico
 Cuivre antique

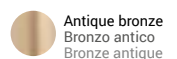

Antique bronze
 Bronzo antico
 Bronze antique

IB BOX

The brilliant way to think about water.

Il modo più geniale per ragionare l'acqua.
La façon la plus géniale de raisonner l'eau.

IB BOX is a universal water mixing system, ready to transform the traditional way of imagining the bathroom. Preliminarily fixed to the wall and adaptable to any IB Rubinetti collection, for faucets or showers, it guarantees thin and light appliances and an absolute and immediate creative freedom.

IB BOX è un sistema universale per la miscelazione dell'acqua, pronto a rivoluzionare il modo tradizionale di pensare il bagno. Preliminarmente montato a muro e adattabile a qualsiasi collezione IB Rubinetti, da lavabo o doccia, garantisce apparecchiature esili e leggere e una libertà creativa assoluta e immediata.

IB BOX est un système universel de mixage de l'eau, prêt à révolutionner la manière traditionnelle de penser à la salle de bain. Installé au mur de façon préliminaire et adaptable à toute collection IB Rubinetti, évier ou douche, il garantit un appareil mince et léger ainsi qu'une liberté de création absolue et immédiate.



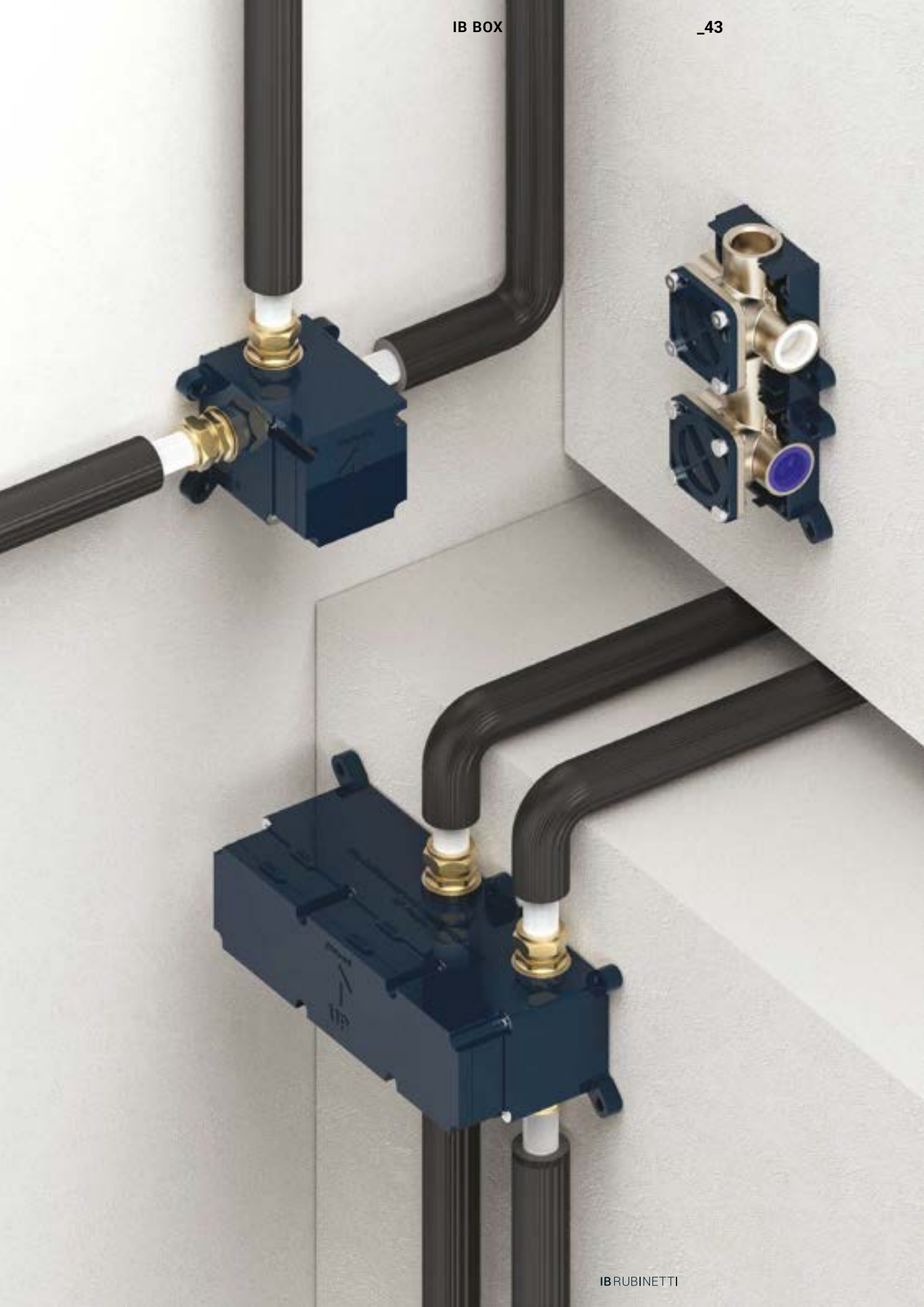

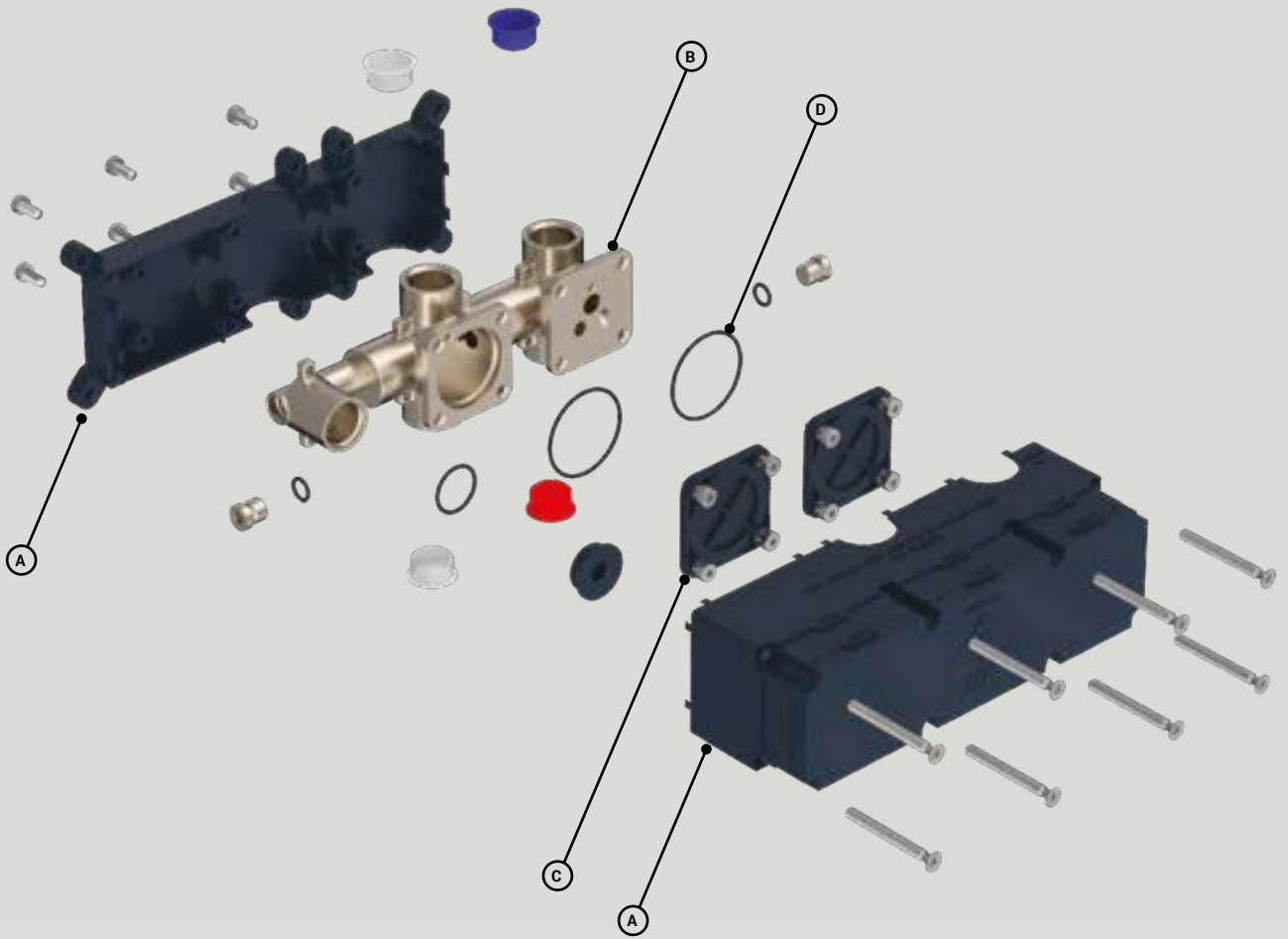

- A** **A front and back plastic case,**
C **equipped with plastic protection**
B **caps, encloses and protects a brass**
D **body, which allows the connection to**
the hydraulic system of the external
components through specific
seals, adaptable to any IB Rubinetti
product on the market.

Un case in plastica (A) frontale e posteriore, fornito di tappi di protezione (C) anch'essi in plastica, racchiude e protegge al suo interno un corpo in ottone (B), che permette l'allaccio all'impianto idraulico delle componenti esterne tramite guarnizioni (D) adattabili a qualsiasi prodotto IB Rubinetti sul mercato.

Un case en plastique (A) antérieur et postérieur, muni de capsules de protection (C) elle aussi en plastique, contient et protège un corps en laiton (B), qui permet le raccordement au circuit hydraulique des composants extérieures à travers des joints (D) adaptables à tout produit IB Rubinetti sur le marché.

Features +

A handy and intuitive system, allowing the maximum performative efficiency and an easy implementation during assembly.

Un sistema comodo e intuitivo, che permette la massima efficienza performativa e una facile applicazione in fase di montaggio.

Un système pratique et intuitif qui permet la meilleure efficacité performative et une application simple en cours de montage.

+ QUICK INSTALLATION

Set up in just a few simple steps, it acts as a universal link for the connection to the hydraulic system.

INSTALLAZIONE RAPIDA

Installabile in poche semplici mosse, funge da tramite universale per l'allaccio all'impianto idraulico.

INSTALLATION RAPIDE

Installé en quelques étapes simples, il sert de lien universel pour la connexion au système hydraulique.

+ EFFICIENT

A unique product, of minimal dimensions and easy to install, which will make the bathroom design practical and fast.

EFFICIENTE

Un prodotto unico, di dimensioni minime e di facile installazione, che renderà la progettazione del bagno pratica e veloce.

EFFICACE

Un produit unique, de dimensions minimales et facile à installer, qui rendra la planification de la salle de bain pratique et rapide.

+ SAFE

The best safety standards are respected, in order to guarantee an efficient and reliable product.

SICURO

Sono rispettati i migliori standard di sicurezza per garantire un prodotto efficiente e affidabile.

SÉCURISÉ

Les meilleures normes de sécurité sont respectées pour garantir un produit efficace et fiable.

+ INTUITIVE

The intuitive device installation provides, in just a few simple steps, a ready-to-use connection support.

INTUITIVO

L'intuitiva installazione dell'apparecchiatura fornisce, in pochi semplici gesti, una base d'allaccio pronta all'utilizzo.

INTUITIF

L'installation intuitive de l'appareil fournit, en quelques étapes simples, une base de connexion prête à l'emploi.

+ EASY MAINTENANCE

The single and compact structure ensures a convenient and rapid maintenance of the system.

MANUTENZIONE COMODA

La struttura singola e compatta assicura un sistema dalla manutenzione comoda e istantanea.

MAINTENANCE PRATIQUE

La structure unique et compacte garantit un système du maintien pratique et instantané.

+ IMMEDIATE AVAILABILITY

The universal system allows to keep a single body in stock for all collections, thus optimizing storage space and ensuring versatility in distribution.

DISPONIBILITÀ IMMEDIATA

Il sistema universale permette di tenere in magazzino un unico corpo per tutte le collezioni, ottimizzando così lo spazio di stoccaggio e garantendo versatilità nella distribuzione.

DISPONIBILITÉ IMMÉDIATE

Le système universel permet de garder en stock un seul corps pour toutes les collections, optimisant ainsi l'espace de stockage et garantissant versatilité dans la distribution.



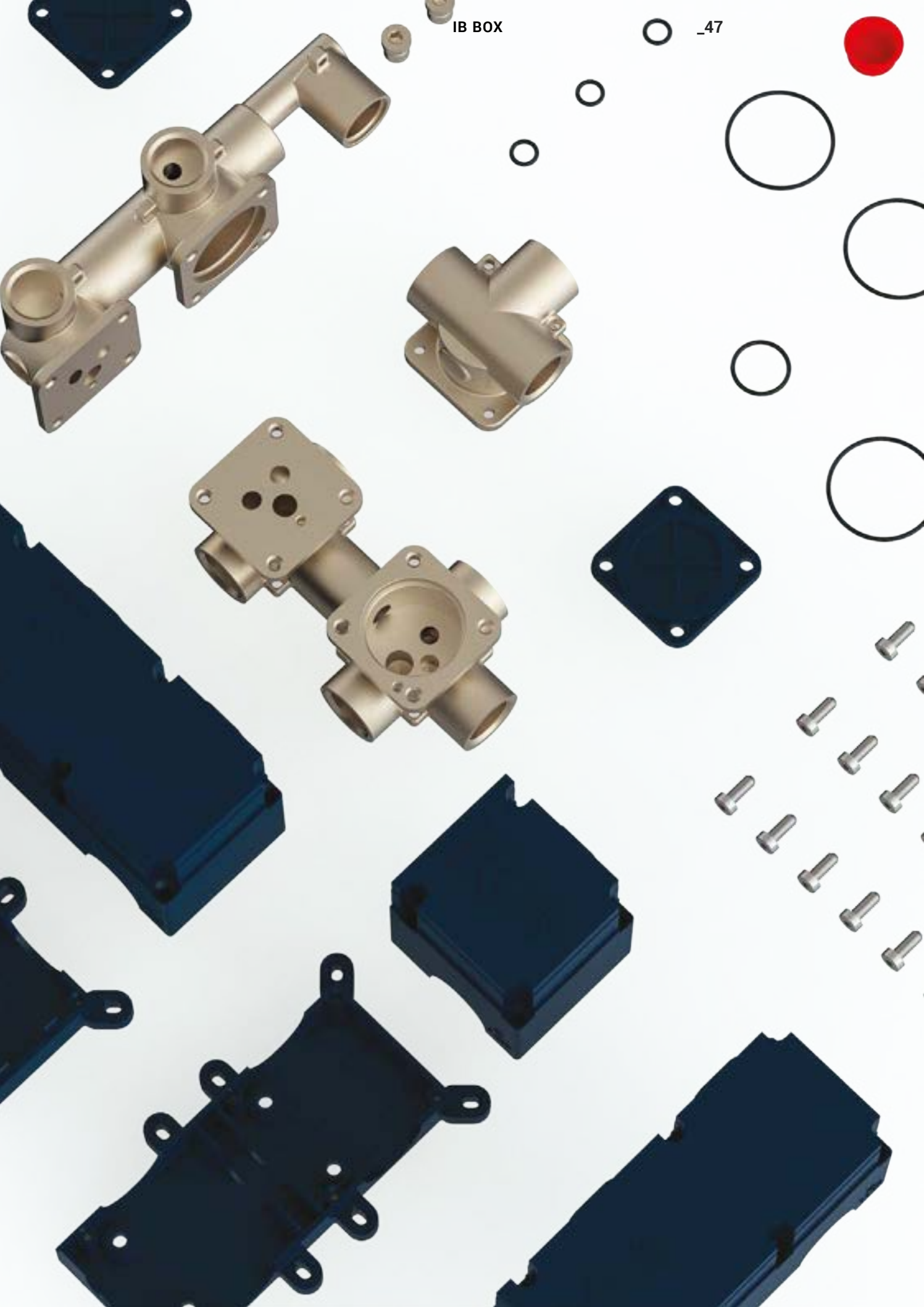

The form follows the function

IB Box is not only content but also form, and guarantees multiple aesthetic advantages, exceptional in their simplicity.

IB Box non è solo contenuto ma anche forma, e garantisce dei vantaggi estetici formidabili nella loro essenzialità.

IB Box n'est pas que du contenu mais il est aussi forme, et il garantit des avantages esthétiques extraordinaires dans leur essentialité.

+ MINIMUM DIMENSION

The space occupied by the technical compartment is minimal, thus ensuring in its external controls a complete and self-contained product.

MINIME DIMENSIONI

Lo spazio occupato dal comparto tecnico è minimo, assicurando così nei comandi esterni un prodotto completo e contenuto nella forma.

DIMENSIONS MINIMALES

L'espace occupé par le département technique est minimal, assurant ainsi, dans les contrôles externes, un produit complet et de forme contenue.

+ SUPER-THIN PLATE

Not only the built-in part, but also the external plates have been redesigned in order to reduce their size, making them extremely thin, elegant and perfectly integrated with the surrounding environment.

PLACCA SUPERSOTTILE

Non solo la parte incassata, ma anche le placche esterne sono state riprogettate per diminuirne le dimensioni, rendendole estremamente sottili, eleganti e perfettamente integrate all'ambiente circostante.

PLAQUE SUPER-FINE

Non seulement la partie incorporé, mais également les plaques externes ont été repensées afin de réduire leur taille, ce qui les rend extrêmement fines, élégantes et parfaitement intégrées au milieu environnant.

+ COMPATIBILITY WITH EVERY COLLECTION

The universal system guarantees absolute compatibility with any IB Rubinetti collection, implementing new types of aesthetic plates adaptable to every series.

COMPATIBILITÀ CON TUTTE LE SERIE

Il sistema universale garantisce una compatibilità assoluta con qualsiasi collezione IB Rubinetti, implementando su di esse delle nuove tipologie di placche estetiche.

COMPATIBILITÉ AVEC TOUTES LES COLLECTIONS

Le système universel garantit une compatibilité absolue avec toutes les collections IB Rubinetti, à travers la mise en œuvre de nouveaux types de plaques esthétiques.

+ ENCOURAGING THE CREATIVE PROJECT

Thanks to its universal formula, it allows to unleash your creativity, satisfying every desire and freeing from the obligation to make the aesthetic choice during the technical installation.

ANIMA IL PROGETTO CREATIVO

Grazie alla sua formula universale permette di dare libero sfogo alla creatività, soddisfacendo ogni desiderio e liberando dall'obbligo di dover compiere la scelta estetica nel momento dell'installazione tecnica.

ANIMER LE PROJET CRÉATIF

Grâce à sa formule universelle, il permet d'assouvir librement la créativité, de satisfaire tout désir et de libérer de la nécessité de faire le choix esthétique lors de l'installation technique.





Simple but effective

In six simple steps, IB Box will be ready to ensure, immediately and in total safety, the essential support to all desires.

In sei semplici passi, IB Box sarà pronto ad assicurare, con immediatezza e in completa sicurezza, il supporto necessario a ogni desiderio.

En six simples étapes, IB Box sera prêt à assurer, avec promptitude et en toute sécurité, le support nécessaire à chaque désir.



The plastic case, which encloses and protects the brass heart, is directly secured to the rough plaster through a system of wall plugs.

Il case in plastica, che racchiude e protegge il cuore in ottone, viene direttamente assicurato all'intonaco grezzo attraverso un sistema di viti tassello.
Le case en plastique, qui entoure et protège le cœur en laiton, est directement fixé au plâtre brut à l'aide d'un système de vis à cheville.



Once fixed, it is connected to the bathroom hydraulic system in a simple and intuitive way, especially thanks to the instructions directly reported on the case, providing all the essential information.

Una volta fissato, esso viene collegato al sistema idraulico del bagno in modo semplice e intuitivo, grazie anche alle istruzioni direttamente riportate sul case, che forniscono tutte le indicazioni necessarie.
Une fois fixé, il est branché au système hydraulique de la salle de bain de manière simple et intuitive, grâce aux instructions affichées directement sur le case, qui fournissent toutes les informations nécessaires.



After having connected it to the hydraulic system, it is possible to proceed to the masonry work. The material chosen to decorate the wall will cover the equipment, leaving only the front case visible.

Dopo averlo allacciato al sistema idraulico, si può procedere al lavoro di muratura. Il materiale scelto per ornare la parete andrà a coprire l'apparecchiatura, lasciando visibile solo il coperchio anteriore.
Après l'avoir connecté au système hydraulique, il est possible de procéder aux travaux de maçonnerie. Le matériau choisi pour décorer le mur couvrira le dispositif, en ne laissant visible que le couvercle antérieur.

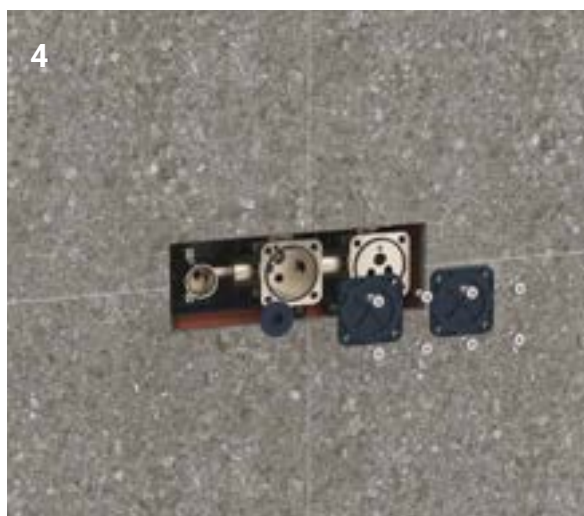

Once the work is completed, IB Box will be ready to use: you will simply have to remove the plastic cover to find inside the brass heart, ready for installation, perfectly flush with the wall.

A lavori ultimati, IB Box sarà pronto per essere utilizzato: basterà sfilare la copertura in plastica per ritrovare all'interno, perfettamente a raso parete, il cuore in ottone necessario all'installazione del prodotto.
Une fois les travaux terminés, IB Box sera prêt à être utilisé: il suffira de enlever la couverture en plastique pour y trouver à l'intérieur le cœur en laiton nécessaire à l'installation du produit, parfaitement au ras du mur.



5

The body of IB Box will therefore act as a connection base, to be completed with all the required seals, depending on the type of IB Rubinetti product desired.

Il corpo di IB Box fungerà quindi da base di allaccio, da completare con tutti le guarnizioni necessarie a seconda della tipologia di prodotto IB Rubinetti desiderato.

Le corps de IB Box servira donc de base de connexion, à compléter avec tous les joints nécessaires, en fonction du type de produit IB Rubinetti souhaité.



6

The super-thin plaque will then easily cover the connections, guaranteeing an elegant product, delicate in its simplicity and lightness, always ready to satisfy all the creative desires and inspirations.

La placca supersottile andrà poi facilmente a coprire gli allacci, garantendo un prodotto elegante e delicato per la sua semplicità e leggerezza, sempre pronto a soddisfare tutte le esigenze e gli estri creativi.

La plaque ultrafine couvrira alors facilement les connexions, garantissant un produit élégant et délicat par sa simplicité et à sa légèreté, toujours prêt à satisfaire tout besoin et toute fantaisie créative.

SHOWER | DOCCIA | DOUCHE

●
1 WAY
1 USCITA
1 VOIE

CODE / COEFFICIENT | CODICE /
COEFFICIENTE | CODE / COEFFICIENT

INC300XXN_19 1,8



DIMENSIONS | DIMENSIONI | DIMENSIONS

84 x 74 x 82

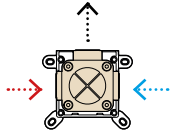

BUILT-IN | INCASSO | ENCASTRÉ

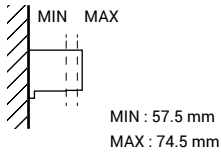

PACKAGING

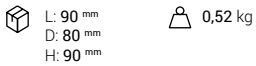

CONTROL | COMANDI | CONTROLLE

One way wall shower mixer
Miscelatore doccia a parete una via
Mitigeur douche mural 1 voie



● ●
2 WAYS
2 USCITE
2 VOIES

CODE / COEFFICIENT | CODICE /
COEFFICIENTE | CODE / COEFFICIENT

INC310XXN_19 3,3



DIMENSIONS | DIMENSIONI | DIMENSIONS

84 x 149 x 82

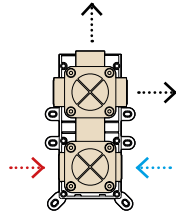

BUILT-IN | INCASSO | ENCASTRÉ

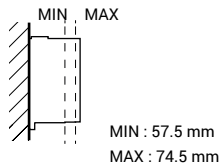

PACKAGING

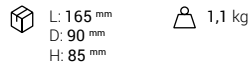

CONTROL | COMANDI | CONTROLLE

Two ways wall shower mixer
Miscelatore doccia a parete con
deviatore due vie
Mitigeur douche mural 2 voies avec
inverseur



● ● ●
3 WAYS
3 USCITE
3 VOIES

CODE / COEFFICIENT | CODICE /
COEFFICIENTE | CODE / COEFFICIENT

INC312XXN_19 3,3



DIMENSIONS | DIMENSIONI | DIMENSIONS

84 x 149 x 82

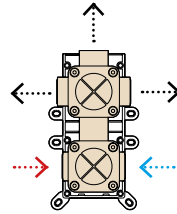

BUILT-IN | INCASSO | ENCASTRÉ

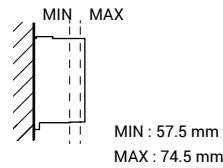

PACKAGING



CONTROL | COMANDI | CONTROLLE

Three ways wall shower mixer
Miscelatore doccia a parete con
deviatore tre vie
Mitigeur douche mural 3 voies avec
inverseur



● ●
2 WAYS
2 USCITE
2 VOIES

CODE / COEFFICIENT | CODICE /
COEFFICIENTE | CODE / COEFFICIENT

INC313XXN_19 3,6



DIMENSIONS | DIMENSIONI | DIMENSIONS

84 x 216 x 82

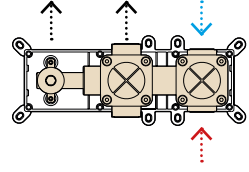

BUILT-IN | INCASSO | ENCASTRÉ

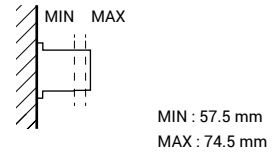

PACKAGING

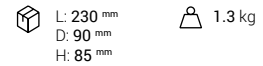

CONTROL | COMANDI | CONTROLLE

Two ways wall shower mixer complete
with shower kit
Miscelatore doccia a parete con
deviatore due vie e doccia integrato
Mitigeur douche mural 2 voies avec
inverseur et douchette encastrée



• • •

3 WAYS
3 USCITE
3 VOIES

CODE / COEFFICIENT | CODICE / COEFFICIENTE |
CODE / COEFFICIENT

INC314XXXN_19 3,7



DIMENSIONS | DIMENSIONI | DIMENSIONS

84 x 216 x 82

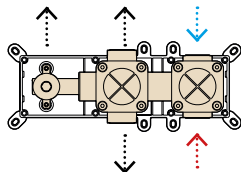

BUILT-IN | INCASSO | ENCASTRÉ

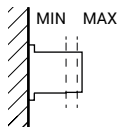

MIN : 57.5 mm
MAX : 74.5 mm

PACKAGING

L: 230 mm 1,28 kg
D: 90 mm
H: 85 mm

CONTROL | COMANDI | CONTROLLE

Three ways wall shower mixer complete with shower kit
Miscelatore doccia a parete con deviatore tre vie e doccia integrato
Mitigeur douche mural 3 voies avec inverseur et douchette encastrée



•

1 WAY
1 USCITA
1 VOIE

CODE / COEFFICIENT | CODICE / COEFFICIENTE |
CODE / COEFFICIENT

INC206XXXN_19 2,9



DIMENSIONS | DIMENSIONI | DIMENSIONS

84 x 216 x 82

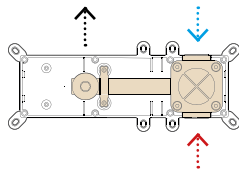

BUILT-IN | INCASSO | ENCASTRÉ

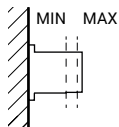

MIN : 57.5 mm
MAX : 74.5 mm

PACKAGING

L: 230 mm 0,8 kg
D: 90 mm
H: 85 mm

CONTROL | COMANDI | CONTROLLE

Wall mounted washbasin mixer
Miscelatore lavabo due fori a parete
Mitigeur lavabo mural



•

1 WAY
1 USCITA
1 VOIE

CODE / COEFFICIENT | CODICE / COEFFICIENTE |
CODE / COEFFICIENT

INC206XXXN_19 2,9



DIMENSIONS | DIMENSIONI | DIMENSIONS

84 x 216 x 82

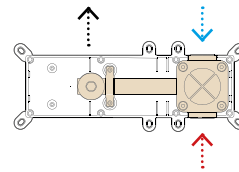

BUILT-IN | INCASSO | ENCASTRÉ

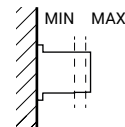

MIN : 57.5 mm
MAX : 74.5 mm

PACKAGING

L: 230 mm 0,8 kg
D: 90 mm
H: 85 mm

CONTROL | COMANDI | CONTROLLE

Shut off
Idroscopino
Ensemble hygiénique





**BOLD ROUND
BOLD LEVER**
P. 56



**MARMO
MARMO L**
P. 88



INDUSTRIA
P. 120



TAAAC
P. 146



K2
P. 166



K3
P. 188



LOVE ME
P. 208



**BELMONDO
BELMONDO ELLE**
P. 234



TWITTER
P. 284



WAVE
P. 262



SUPERBOX
P. 304



MILANOTORINO
P. 322



BATLÒ
P. 346



ONLY ONE
P. 370



RUBACUORI
P. 394



HEY JOE!
P. 418



WOW
P. 442



BIRKIN
P. 454



**HERMES
HERMES ELLE**
P. 468



**KUSASI
KUSASI SHORT**
P. 496



POWA
P. 518



BYE BYE
P. 520

BH

BATHROOM
BAGNO
BAIN

BOLD ROUND & LEVER

The faucet collection for character spaces.

La collezione di rubinetti per ambienti di carattere.

La collection de robinets pour les espaces de caractères.

Inspired by the traditional forms of the industrial faucet, the BOLD collection is marked by solid outlines and essential and functional forms, making it the better choice for spaces with strong features and personality. Available in ten different finishes and in two varieties of lever, Bold reinvents a regular design by capturing its essence and renovating it with the addition of little peculiar details, for a collection design bold like its name.

Ispirata alle forme tradizionali del rubinetto industriale, la collezione BOLD è contraddistinta da contorni robusti e forme essenziali e funzionali, che la rendono adatta ad ambienti dal forte carattere e dalla personalità decisa. Disponibile in dieci differenti finiture e in due varietà di leva, Bold reinventa un design consueto catturandone l'essenza e rinnovandola tramite l'aggiunta di piccoli particolari non ordinari, per un design audace come il suo nome.

Inspirée à les formes traditionnelles du robinet industriel, la collection BOLD se caractérise par des contours solides et des formes essentielles et fonctionnelles, qui la rendent apte aux environnements au caractère et personnalité forts. Disponible en dix finitions différentes et en deux typologies de poignée, Bold réinvente un design coutumier, en capturant son essence, en le renouvelant par l'adjonction de détails qui ne sont pas ordinaires et en créant ainsi un design audacieux comme son nom.



KITCHEN
AVAILABLE



DOUBLE LEVER



LEAD FREE



ZINC FREE





The BOLD collection is the perfect combination of elemental elements reinterpreted in a contemporary way.

La collezione BOLD è la perfetta combinazione di elementi elementari, reinterpretati in chiave contemporanea.

La collection BOLD est la combinaison parfaite d'éléments élémentaires réinterprétés de façon contemporaine.

“ We have been fascinated by the utilitarian design of industrial valves taps, their proportions and strong features have been a great source of inspiration. At the same time we wanted to counterbalance this heavy look with an extremely refined range of finishes spanning going from matte black to natural brass and an extremely precise knurl etching on the grip connection details. The BOLD collection is the perfect combination of elemental elements reinterpreted in a contemporary way to suit a large spectrum of bathroom styles and a precise clear statement about water control.

Siamo rimasti affascinati dal design funzionale delle valvole industriali dei rubinetti, le loro proporzioni e il loro carattere deciso sono stati una fondamentale fonte di ispirazione. Allo stesso tempo, volevamo controbilanciare questo look duro con una gamma altamente raffinata di finiture, che spaziano dal nero opaco all'ottone naturale, e di zigrinature incise sui dettagli delle manopole. La collezione BOLD è la combinazione perfetta di elementi elementari, reinterpretati in chiave contemporanea per adattarsi a un ampio spettro di stili, e una precisa dichiarazione d'intenti riguardo al controllo dell'acqua

Nous avons été fascinés par le design fonctionnel des valves de la robinetterie industrielle. Leurs proportions et leur caractère résolu ont été une grande source d'inspiration. En même temps, nous voulions contrebalancer ce heavy look avec l'ajoute d'une gamme de finitions extrêmement raffinées, allant du noir mat au laiton naturel, et de gravures moletées sur les détails des manettes. La collection BOLD est la combinaison parfaite d'éléments élémentaires, réinterprétés de façon contemporaine pour s'adapter à un large éventail de styles, et une déclaration claire de nos intentions au sujet du contrôle de l'eau. ”

Federico Castelli & Antonio Gardoni design for BOLD







- ↑ **B2209CC_6**
 Mono hole wall mounted washbasin mixer
 Miscelatore lavabo a parete monoforo
 Mitigeur lavabo mural monotrou
- ↙ **B1205CC**
 Monohole washbasin with two handles
 Lavabo monoforo con due leve
 Lavabo monotrou mélangeur
- **B2202SS**
 Tall monohole washbasin mixer
 Miscelatore lavabo monoforo alto
 Mitigeur lavabo Haut







↑ B1390SS
Three holes washbasin set with tall spout
Lavabo tre fori bocca alta
Lavabo trois trous bec haut

→ B1200NP
Monohole washbasin mixer
Miscelatore lavabo monoforo
Mitigeur lavabo

← B2200SS
Monohole washbasin mixer
Miscelatore lavabo monoforo
Mitigeur lavabo







← B1306CC_6
Wall mounted washbasin mixer
Miscelatore lavabo due fori a parete
Mítigeur lavabo mural

↑ B2390CC
Three holes washbasin set with tall spout
Lavabo tre fori bocca alta
Lavabo trois trous bec haut

→ B1392ON
Three holes washbasin set with low spout
Lavabo tre fori bocca bassa
Lavabo trois trous bec bas

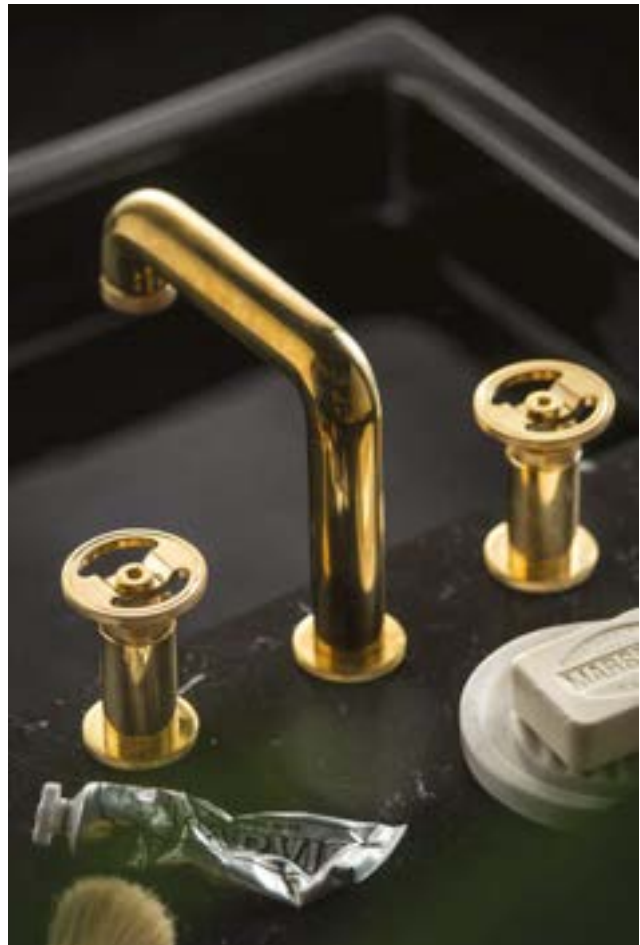



- ↖ **B2312CC**
Exposed parts for manual wall mixer with three ways diverter
Set di parti esterne per miscelatore a parete a tre vie
Partie extérieure pour mitigeur encastré à trois voies
- ← **B2410CC**
Three holes wall mounted shower with two ways diverter
Tre rubinetti a parete per doccia con deviatore a due vie
Melangeur trois trous douche avec inverseur deux voies
- **B2314CC**
Exposed parts for manual wall mixer with three ways diverter complete with shower kit
Set di parti esterne per miscelatore a parete a tre vie completo di kit doccia
Partie extérieure pour mitigeur encastré à trois voies avec douchette





← KB18000
 Thermostatic valve shower control detail
 Dettaglio del comando termostatico doccia
 Détail du contrôle thermostatique de la douche

A Thermostatic valve
 Valvola termostatica
 Valve thermostatique

B Water flow regulation
 Regolazione flusso d'acqua
 Régulation débit d'eau

→ KB1800CS
 Shower column with mixer and shower kit
 Colonna doccia con miscelatore con kit doccia
 Colonne de douche avec mitigeur et kit douche

↓ Showerhead detail
 Dettaglio del soffione doccia
 Détail de la tête de la douche







← KB170000

Free-standing two columns bath filler with shower kit
 Bordo vasca da terra a doppia colonna con kit doccia
 Mélangeur bain/douche complet avec alimentation sol

Bold

Diverter integrated with PULL and TURN system
 Deviatore integrato con sistema PULL and TURN
 Déviateur intégré avec système PULL AND TURN

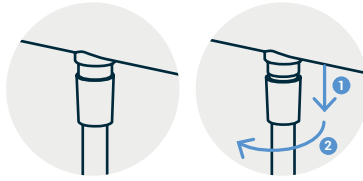

↑ KB2398CC

Five holes wall mounted bath filler with shower kit
 Bordo vasca a parete cinque fori con deviatore e kit doccia
 Bain/douche cinq trous avec inverseur et kit douche

- | | |
|---|--|
| A Hot water Acqua calda Eau chaude | D Diverter Deviatore Déviateur |
| B Spout Bocca d'erogazione Bec | E Hand shower Doccino Douchette |
| C Cold water Acqua fredda Eau froide | |

ARTICLE | ARTICOLO | ARTICLE

B1200



Monohole washbasin mixer complete with drain

Miscelatore lavabo monoforo completo di scarico automatico

Mitigeur lavabo complet avec bonde automatique

CODE / COEFFICIENT | CODICE /
COEFFICIENTE | CODE / COEFFICIENT

| | | |
|------|---------|------|
| ● CC | B1200CC | 11,1 |
| ● SS | B1200SS | 13,9 |
| ● ON | B1200ON | 11,1 |
| ● NP | B1200NP | 13,3 |
| ● CF | B1200CF | 16,7 |
| ● CS | B1200CS | 17,8 |
| ● II | B1200II | 16,7 |
| ● IS | B1200IS | 17,8 |
| ● RS | B1200RS | 16,7 |
| ● SR | B1200SR | 17,8 |
| ● OO | B1200OO | 16,7 |
| ● OS | B1200OS | 17,8 |

.6 LEVA ROSSA | RED LEVER | LEVIER ROUGE + 0,1

PACKAGING

L: 240 mm
D: 215 mm
H: 110 mm

2,5 kg

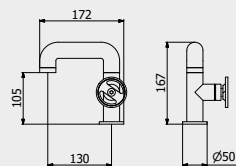

PORTATE | WATER FLOW | DÉBIT D'EAU

| | | |
|-------|---------|---------|
| 1 BAR | 2 BAR | 3 BAR |
| 3 l/m | 4,4 l/m | 4,5 l/m |

ARTICLE | ARTICOLO | ARTICLE

B2200



Monohole washbasin mixer complete with drain

Miscelatore lavabo monoforo completo di scarico automatico

Mitigeur lavabo complet avec bonde automatique

CODE / COEFFICIENT | CODICE /
COEFFICIENTE | CODE / COEFFICIENT

| | | |
|------|---------|------|
| ● CC | B2200CC | 11,1 |
| ● SS | B2200SS | 13,9 |
| ● ON | B2200ON | 11,1 |
| ● NP | B2200NP | 13,3 |
| ● CF | B2200CF | 16,7 |
| ● CS | B2200CS | 17,8 |
| ● II | B2200II | 16,7 |
| ● IS | B2200IS | 17,8 |
| ● RS | B2200RS | 16,7 |
| ● SR | B2200SR | 17,8 |
| ● OO | B2200OO | 16,7 |
| ● OS | B2200OS | 17,8 |

.6 LEVA ROSSA | RED LEVER | LEVIER ROUGE + 0,1

PACKAGING

L: 240 mm
D: 215 mm
H: 110 mm

2,5 kg

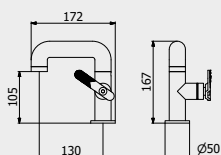

PORTATE | WATER FLOW | DÉBIT D'EAU

| | | |
|-------|---------|---------|
| 1 BAR | 2 BAR | 3 BAR |
| 3 l/m | 4,4 l/m | 4,5 l/m |

ARTICLE | ARTICOLO | ARTICLE

B1202



Tall monohole washbasin mixer complete with drain

Miscelatore lavabo monoforo alto completo di scarico automatico

Mitigeur lavabo Haut complet avec bonde automatique

CODE / COEFFICIENT | CODICE /
COEFFICIENTE | CODE / COEFFICIENT

| | | |
|------|---------|------|
| ● CC | B1202CC | 12,6 |
| ● SS | B1202SS | 15,8 |
| ● ON | B1202ON | 12,6 |
| ● NP | B1202NP | 15,1 |
| ● CF | B1202CF | 18,9 |
| ● CS | B1202CS | 20,2 |
| ● II | B1202II | 18,9 |
| ● IS | B1202IS | 20,2 |
| ● RS | B1202RS | 18,9 |
| ● SR | B1202SR | 20,2 |
| ● OO | B1202OO | 18,9 |
| ● OS | B1202OS | 20,2 |

.6 LEVA ROSSA | RED LEVER | LEVIER ROUGE + 0,1

PACKAGING

L: 360 mm
D: 220 mm
H: 150 mm

3,1 kg

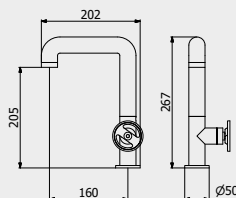

PORTATE | WATER FLOW | DÉBIT D'EAU

| | | |
|-------|---------|---------|
| 1 BAR | 2 BAR | 3 BAR |
| 3 l/m | 4,4 l/m | 4,5 l/m |

ARTICLE | ARTICOLO | ARTICLE

B2202



Tall monohole washbasin mixer complete with drain

Miscelatore lavabo monoforo alto completo di scarico automatico

Mitigeur lavabo Haut complet avec bonde automatique

CODE / COEFFICIENT | CODICE /
COEFFICIENTE | CODE / COEFFICIENT

| | | |
|------|---------|------|
| ● CC | B2202CC | 12,6 |
| ● SS | B2202SS | 15,8 |
| ● ON | B2202ON | 12,6 |
| ● NP | B2202NP | 15,1 |
| ● CF | B2202CF | 18,9 |
| ● CS | B2202CS | 20,2 |
| ● II | B2202II | 18,9 |
| ● IS | B2202IS | 20,2 |
| ● RS | B2202RS | 18,9 |
| ● SR | B2202SR | 20,2 |
| ● OO | B2202OO | 18,9 |
| ● OS | B2202OS | 20,2 |

.6 LEVA ROSSA | RED LEVER | LEVIER ROUGE + 0,1

PACKAGING

L: 360 mm
D: 220 mm
H: 150 mm

3,1 kg

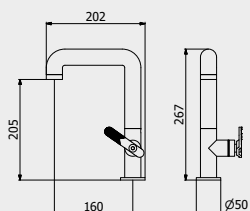

PORTATE | WATER FLOW | DÉBIT D'EAU

| | | |
|-------|---------|---------|
| 1 BAR | 2 BAR | 3 BAR |
| 3 l/m | 4,4 l/m | 4,5 l/m |



ARTICLE | ARTICOLO | ARTICLE

B1205



Monohole washbasin with two handles complete with drain
Lavabo monoforo con due leve completo di scarico automatico
Mélangeur lavabo monotrou complet avec bonde automatique

| CODE / COEFFICIENT | CODICE / COEFFICIENTE | |
|--------------------|---------------------------------------|-------|
| CC | B1205CC | 13,9 |
| SS | B1205SS | 17,4 |
| ON | B1205ON | 13,9 |
| NP | B1205NP | 16,7 |
| CF | B1205CF | 20,9 |
| CS | B1205CS | 22,2 |
| II | B1205II | 20,9 |
| IS | B1205IS | 22,2 |
| RS | B1205RS | 20,9 |
| SR | B1205SR | 22,2 |
| OO | B1205OO | 20,9 |
| OS | B1205OS | 22,2 |
| 6 | LEVA ROSSA RED LEVER LEVIER ROUGE | + 0,2 |

PACKAGING

L: 353 mm
D: 225 mm
H: 226 mm
3,4 kg

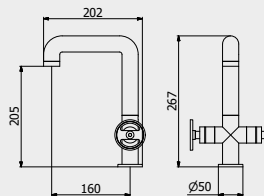

PORTATE | WATER FLOW | DÉBIT D'EAU

| | | |
|---------|---------|---------|
| 1 BAR | 2 BAR | 3 BAR |
| 3,3 l/m | 4,4 l/m | 4,5 l/m |

ARTICLE | ARTICOLO | ARTICLE

B2205



Monohole washbasin with two handles complete with drain
Lavabo monoforo con due leve completo di scarico automatico
Mélangeur lavabo monotrou complet avec bonde automatique

| CODE / COEFFICIENT | CODICE / COEFFICIENTE | |
|--------------------|---------------------------------------|-------|
| CC | B2205CC | 13,9 |
| SS | B2205SS | 17,4 |
| ON | B2205ON | 13,9 |
| NP | B2205NP | 16,7 |
| CF | B2205CF | 20,9 |
| CS | B2205CS | 22,2 |
| II | B2205II | 20,9 |
| IS | B2205IS | 22,2 |
| RS | B2205RS | 20,9 |
| SR | B2205SR | 22,2 |
| OO | B2205OO | 20,9 |
| OS | B2205OS | 22,2 |
| 6 | LEVA ROSSA RED LEVER LEVIER ROUGE | + 0,2 |

PACKAGING

L: 353 mm
D: 225 mm
H: 226 mm
3,4 kg

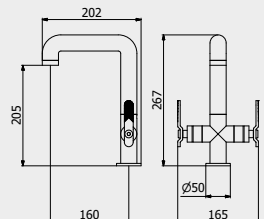

PORTATE | WATER FLOW | DÉBIT D'EAU

| | | |
|---------|---------|---------|
| 1 BAR | 2 BAR | 3 BAR |
| 3,3 l/m | 4,4 l/m | 4,5 l/m |

ARTICLE | ARTICOLO | ARTICLE

B2206



Wall mounted washbasin mixer complete with drain
Miscelatore lavabo due fori a parete completo di scarico automatico
Mitigeur lavabo mural complet avec bonde automatique

| CODE / COEFFICIENT | CODICE / COEFFICIENTE | |
|--------------------|---------------------------------------|-------|
| CC | EB2206CC | 12,6 |
| SS | EB2206SS | 15,8 |
| ON | EB2206ON | 12,6 |
| NP | EB2206NP | 15,1 |
| CF | EB2206CF | 18,9 |
| CS | EB2206CS | 20,2 |
| II | EB2206II | 18,9 |
| IS | EB2206IS | 20,2 |
| RS | EB2206RS | 18,9 |
| SR | EB2206SR | 20,2 |
| OO | EB2206OO | 18,9 |
| OS | EB2206OS | 20,2 |
| 6 | LEVA ROSSA RED LEVER LEVIER ROUGE | + 0,1 |

PACKAGING

L: 265 mm
D: 260 mm
H: 70 mm
1,7 kg

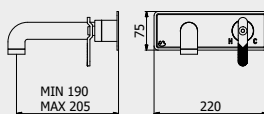

PORTATE | WATER FLOW | DÉBIT D'EAU

| | | |
|---------|---------|---------|
| 1 BAR | 2 BAR | 3 BAR |
| 3,3 l/m | 4,4 l/m | 4,5 l/m |

Built-in body to be purchased separately
Corpo incasso da acquistare separatamente
Corps intégré à acheter séparément



CODICE | CODE | CODE

INC206XXXN_19

COEFFICIENT | COEFFICIENTE | COEFFICIENT

2,9



ARTICLE | ARTICOLO | ARTICLE

B1209



Mono hole wall mounted washbasin mixer

Miscelatore lavabo a parete monoforo completo di scarico automatico
Mitigeur lavabo mural monotrou complet avec bonde automatique

| CODE / COEFFICIENT | CODICE / COEFFICIENTE | |
|--------------------|---------------------------------------|-------|
| CC | B1209CC | 14,1 |
| SS | B1209SS | 17,6 |
| ON | B1209ON | 14,1 |
| NP | B1209NP | 16,9 |
| CF | B1209CF | 21,2 |
| CS | B1209CS | 22,6 |
| II | B1209II | 21,2 |
| IS | B1209IS | 22,6 |
| RS | B1209RS | 21,2 |
| SR | B1209SR | 22,6 |
| OO | B1209OO | 21,2 |
| OS | B1209OS | 22,6 |
| _6 | LEVA ROSSA RED LEVER LEVIER ROUGE | + 0,1 |

PACKAGING

L: 425 mm
D: 188 mm
H: 98 mm

2,1 kg

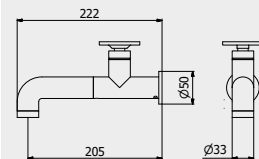

PORTATE | WATER FLOW | DÉBIT D'EAU

| 1 BAR | 2 BAR | 3 BAR |
|---------|---------|---------|
| 3,3 l/m | 4,4 l/m | 4,5 l/m |

ARTICLE | ARTICOLO | ARTICLE

B2209



Mono hole wall mounted washbasin mixer

Miscelatore lavabo a parete monoforo completo di scarico automatico
Mitigeur lavabo mural monotrou complet avec bonde automatique

| CODE / COEFFICIENT | CODICE / COEFFICIENTE | |
|--------------------|---------------------------------------|-------|
| CC | B2209CC | 14,1 |
| SS | B2209SS | 17,6 |
| ON | B2209ON | 14,1 |
| NP | B2209NP | 16,9 |
| CF | B2209CF | 21,2 |
| CS | B2209CS | 22,6 |
| II | B2209II | 21,2 |
| IS | B2209IS | 22,6 |
| RS | B2209RS | 21,2 |
| SR | B2209SR | 22,6 |
| OO | B2209OO | 21,2 |
| OS | B2209OS | 22,6 |
| _6 | LEVA ROSSA RED LEVER LEVIER ROUGE | + 0,1 |

PACKAGING

L: 425 mm
D: 188 mm
H: 98 mm

2,1 kg

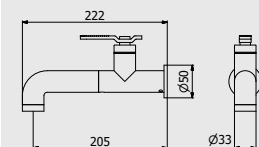

PORTATE | WATER FLOW | DÉBIT D'EAU

| 1 BAR | 2 BAR | 3 BAR |
|---------|---------|---------|
| 3,3 l/m | 4,4 l/m | 4,5 l/m |

ARTICLE | ARTICOLO | ARTICLE

B2210



Ceiling spout with wall mounted mixer

Bocca da soffitto con comando remoto ad incasso
Mitigeur lavabo mural avec bec plafond complet avec bonde automatique

| CODE / COEFFICIENT | CODICE / COEFFICIENTE | |
|--------------------|---------------------------------------|-------|
| CC | EB2210CC | 30,9 |
| SS | EB2210SS | 38,7 |
| ON | EB2210ON | 30,9 |
| NP | EB2210NP | 37,1 |
| CF | EB2210CF | 46,4 |
| CS | EB2210CS | 49,5 |
| II | EB2210II | 46,4 |
| IS | EB2210IS | 49,5 |
| RS | EB2210RS | 46,4 |
| SR | EB2210SR | 49,5 |
| OO | EB2210OO | 46,4 |
| OS | EB2210OS | 49,5 |
| _6 | LEVA ROSSA RED LEVER LEVIER ROUGE | + 0,1 |

PACKAGING

L: 150 mm
D: 190 mm
H: 98 mm

L: 1700 mm
Ø: 70 mm

4,5 kg

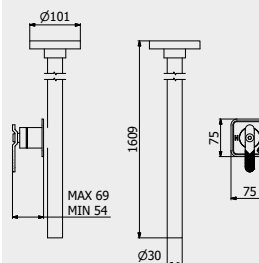

PORTATE | WATER FLOW | DÉBIT D'EAU

| 1 BAR | 2 BAR | 3 BAR |
|---------|---------|---------|
| 4,3 l/m | 5,2 l/m | 6,9 l/m |

Built-in body to be purchased separately

Corpo incasso da acquistare separatamente

Corps intégré à acheter séparément



CODICE | CODE | CODE

INC300XXXN_19

COEFFICIENT | COEFFICIENTE | COEFFICIENT

1,8



ARTICLE | ARTICOLO | ARTICLE

B1306



Wall mounted widespread lavatory faucet
 Rubinetto lavabo da incasso
 Robinet de lavabo mural

| CODE / COEFFICIENT | CODICE / COEFFICIENTE | |
|--------------------|---------------------------------------|-------|
| CC | B1306CC | 13,6 |
| SS | B1306SS | 17,0 |
| ON | B1306ON | 13,6 |
| NP | B1306NP | 16,3 |
| CF | B1306CF | 20,4 |
| CS | B1306CS | 21,8 |
| II | B1306II | 20,4 |
| IS | B1306IS | 21,8 |
| RS | B1306RS | 20,4 |
| SR | B1306SR | 21,8 |
| OO | B1306OO | 20,4 |
| OS | B1306OS | 21,8 |
| 6 | LEVA ROSSA RED LEVER LEVIER ROUGE | + 0,2 |

PACKAGING

L: 370 mm
 D: 270 mm
 H: 80 mm
 2,4 kg

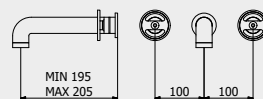

| PORTATE | WATER FLOW | DÉBIT D'EAU |
|---------|------------|-------------|
| 1 BAR | 2 BAR | 3 BAR |
| 3,3 l/m | 4,4 l/m | 4,5 l/m |

ARTICLE | ARTICOLO | ARTICLE

B2306



Wall mounted widespread lavatory faucet
 Rubinetto lavabo da incasso
 Robinet de lavabo mural

| CODE / COEFFICIENT | CODICE / COEFFICIENTE | |
|--------------------|---------------------------------------|-------|
| CC | B2306CC | 13,6 |
| SS | B2306SS | 17,0 |
| ON | B2306ON | 13,6 |
| NP | B2306NP | 16,3 |
| CF | B2306CF | 20,4 |
| CS | B2306CS | 21,8 |
| II | B2306II | 20,4 |
| IS | B2306IS | 21,8 |
| RS | B2306RS | 20,4 |
| SR | B2306SR | 21,8 |
| OO | B2306OO | 20,4 |
| OS | B2306OS | 21,8 |
| 6 | LEVA ROSSA RED LEVER LEVIER ROUGE | + 0,2 |

PACKAGING

L: 370 mm
 D: 270 mm
 H: 80 mm
 2,4 kg

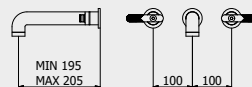

| PORTATE | WATER FLOW | DÉBIT D'EAU |
|---------|------------|-------------|
| 1 BAR | 2 BAR | 3 BAR |
| 3,3 l/m | 4,4 l/m | 4,5 l/m |

ARTICLE | ARTICOLO | ARTICLE

B1390



Three holes washbasin set with tall spout
 Lavabo tre fori bocca alta completo di scarico automatico
 Lavabo trois trous bec haut

| CODE / COEFFICIENT | CODICE / COEFFICIENTE | |
|--------------------|---------------------------------------|-------|
| CC | B1390CC | 17,1 |
| SS | B1390SS | 21,4 |
| ON | B1390ON | 17,1 |
| NP | B1390NP | 20,5 |
| CF | B1390CF | 25,7 |
| CS | B1390CS | 27,4 |
| II | B1390II | 25,7 |
| IS | B1390IS | 27,4 |
| RS | B1390RS | 25,7 |
| SR | B1390SR | 27,4 |
| OO | B1390OO | 25,7 |
| OS | B1390OS | 27,4 |
| 6 | LEVA ROSSA RED LEVER LEVIER ROUGE | + 0,2 |

PACKAGING

L: 455 mm
 D: 310 mm
 H: 75 mm
 2,2 kg

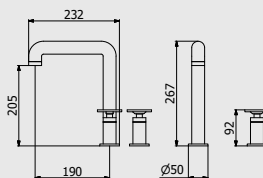

| PORTATE | WATER FLOW | DÉBIT D'EAU |
|---------|------------|-------------|
| 1 BAR | 2 BAR | 3 BAR |
| 3,3 l/m | 4,4 l/m | 4,5 l/m |

ARTICLE | ARTICOLO | ARTICLE

B2390



Three holes washbasin set with tall spout
 Lavabo tre fori bocca alta completo di scarico automatico
 Lavabo trois trous bec haut

| CODE / COEFFICIENT | CODICE / COEFFICIENTE | |
|--------------------|---------------------------------------|-------|
| CC | B2390CC | 17,1 |
| SS | B2390SS | 21,4 |
| ON | B2390ON | 17,1 |
| NP | B2390NP | 20,5 |
| CF | B2390CF | 25,7 |
| CS | B2390CS | 27,4 |
| II | B2390II | 25,7 |
| IS | B2390IS | 27,4 |
| RS | B2390RS | 25,7 |
| SR | B2390SR | 27,4 |
| OO | B2390OO | 25,7 |
| OS | B2390OS | 27,4 |
| 6 | LEVA ROSSA RED LEVER LEVIER ROUGE | + 0,2 |

PACKAGING

L: 455 mm
 D: 310 mm
 H: 75 mm
 2,2 kg

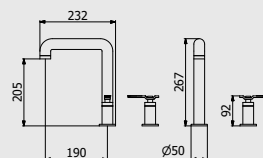

| PORTATE | WATER FLOW | DÉBIT D'EAU |
|---------|------------|-------------|
| 1 BAR | 2 BAR | 3 BAR |
| 3,3 l/m | 4,4 l/m | 4,5 l/m |

ARTICLE | ARTICOLO | ARTICLE

B1392



Three holes washbasin set with low spout

Lavabo tre fori a bocca bassa completo di scarico automatico

Lavabo trois trous bec bas

CODE / COEFFICIENT | CODICE /
COEFFICIENTE | CODE / COEFFICIENT

| | | |
|------|---------|------|
| ● CC | B1392CC | 15,6 |
| ● SS | B1392SS | 19,5 |
| ● ON | B1392ON | 15,6 |
| ● NP | B1392NP | 18,7 |
| ● CF | B1392CF | 23,4 |
| ● CS | B1392CS | 25,0 |
| ● II | B1392II | 23,4 |
| ● IS | B1392IS | 25,0 |
| ● RS | B1392RS | 23,4 |
| ● SR | B1392SR | 25,0 |
| ● OO | B1392OO | 23,4 |
| ● OS | B1392OS | 25,0 |

PACKAGING

 L: 455 mm
D: 310 mm
H: 75 mm

4,4 kg

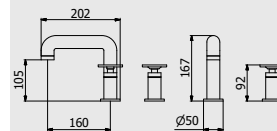

PORTATE | WATER FLOW | DÉBIT D'EAU

| | | |
|---------|---------|---------|
| 1 BAR | 2 BAR | 3 BAR |
| 3,3 l/m | 4,4 l/m | 4,5 l/m |

ARTICLE | ARTICOLO | ARTICLE

B2392



Three holes washbasin set with low spout

Lavabo tre fori a bocca bassa completo di scarico automatico

Lavabo trois trous bec bas

CODE / COEFFICIENT | CODICE /
COEFFICIENTE | CODE / COEFFICIENT

| | | |
|------|---------|------|
| ● CC | B2392CC | 15,6 |
| ● SS | B2392SS | 19,5 |
| ● ON | B2392ON | 15,6 |
| ● NP | B2392NP | 18,7 |
| ● CF | B2392CF | 23,4 |
| ● CS | B2392CS | 25,0 |
| ● II | B2392II | 23,4 |
| ● IS | B2392IS | 25,0 |
| ● RS | B2392RS | 23,4 |
| ● SR | B2392SR | 25,0 |
| ● OO | B2392OO | 23,4 |
| ● OS | B2392OS | 25,0 |

PACKAGING

 L: 455 mm
D: 310 mm
H: 75 mm

4,4 kg

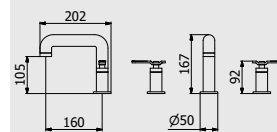

PORTATE | WATER FLOW | DÉBIT D'EAU

| | | |
|---------|---------|---------|
| 1 BAR | 2 BAR | 3 BAR |
| 3,3 l/m | 4,4 l/m | 4,5 l/m |

ARTICLE | ARTICOLO | ARTICLE

B1220



Monohole bidet mixer complete with drain

Miscelatore bidet monoforo completo di scarico automatico

Mitigeur bidet complet avec bonde automatique

CODE / COEFFICIENT | CODICE /
COEFFICIENTE | CODE / COEFFICIENT

| | | |
|------|---------|------|
| ● CC | B1220CC | 11,1 |
| ● SS | B1220SS | 13,9 |
| ● ON | B1220ON | 11,1 |
| ● NP | B1220NP | 13,3 |
| ● CF | B1220CF | 16,7 |
| ● CS | B1220CS | 17,8 |
| ● II | B1220II | 16,7 |
| ● IS | B1220IS | 17,8 |
| ● RS | B1220RS | 16,7 |
| ● SR | B1220SR | 17,8 |
| ● OO | B1220OO | 16,7 |
| ● OS | B1220OS | 17,8 |

PACKAGING

 L: 240 mm
D: 215 mm
H: 110 mm

2,2 kg

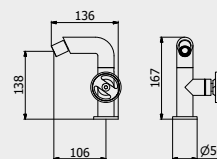

PORTATE | WATER FLOW | DÉBIT D'EAU

| | | |
|-------|-------|---------|
| 1 BAR | 2 BAR | 3 BAR |
| 5 l/m | 7 l/m | 8,6 l/m |

ARTICLE | ARTICOLO | ARTICLE

B2220



Monohole bidet mixer complete with drain

Miscelatore bidet monoforo completo di scarico automatico

Mitigeur bidet complet avec bonde automatique

CODE / COEFFICIENT | CODICE /
COEFFICIENTE | CODE / COEFFICIENT

| | | |
|------|---------|------|
| ● CC | B2220CC | 11,1 |
| ● SS | B2220SS | 13,9 |
| ● ON | B2220ON | 11,1 |
| ● NP | B2220NP | 13,3 |
| ● CF | B2220CF | 16,7 |
| ● CS | B2220CS | 17,8 |
| ● II | B2220II | 16,7 |
| ● IS | B2220IS | 17,8 |
| ● RS | B2220RS | 16,7 |
| ● SR | B2220SR | 17,8 |
| ● OO | B2220OO | 16,7 |
| ● OS | B2220OS | 17,8 |

PACKAGING

 L: 240 mm
D: 215 mm
H: 110 mm

2,2 kg

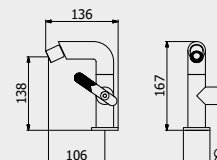

PORTATE | WATER FLOW | DÉBIT D'EAU

| | | |
|-------|-------|---------|
| 1 BAR | 2 BAR | 3 BAR |
| 5 l/m | 7 l/m | 8,6 l/m |



ARTICLE | ARTICOLO | ARTICLE

B1393



Three holes bidet set

Bidet tre fori con bocca snodabile completo di scarico automatico
Bidet trois trous

| CODE / COEFFICIENT CODICE / COEFFICIENTE | COEFFICIENTE CODE / COEFFICIENT |
|--|-----------------------------------|
| CC B1393CC | 15,0 |
| SS B1393SS | 18,8 |
| ON B1393ON | 15,0 |
| NP B1393NP | 18,0 |
| CF B1393CF | 22,5 |
| CS B1393CS | 24,0 |
| II B1393II | 22,5 |
| IS B1393IS | 24,0 |
| RS B1393RS | 22,5 |
| SR B1393SR | 24,0 |
| OO B1393OO | 22,5 |
| OS B1393OS | 24,0 |
| _6 LEVA ROSSA RED LEVER LEVIER ROUGE | + 0,2 |

PACKAGING

L: 455 mm
D: 310 mm
H: 75 mm

4,4 kg

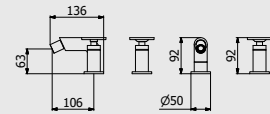

PORTATE | WATER FLOW | DÉBIT D'EAU

| | | |
|---------|---------|---------|
| 1 BAR | 2 BAR | 3 BAR |
| 3,3 l/m | 4,4 l/m | 4,5 l/m |

ARTICLE | ARTICOLO | ARTICLE

B2393



Three holes bidet set

Bidet tre fori con bocca snodabile completo di scarico automatico
Bidet trois trous

| CODE / COEFFICIENT CODICE / COEFFICIENTE | COEFFICIENTE CODE / COEFFICIENT |
|--|-----------------------------------|
| CC B2393CC | 15,0 |
| SS B2393SS | 18,8 |
| ON B2393ON | 15,0 |
| NP B2393NP | 18,0 |
| CF B2393CF | 22,5 |
| CS B2393CS | 24,0 |
| II B2393II | 22,5 |
| IS B2393IS | 24,0 |
| RS B2393RS | 22,5 |
| SR B2393SR | 24,0 |
| OO B2393OO | 22,5 |
| OS B2393OS | 24,0 |
| _6 LEVA ROSSA RED LEVER LEVIER ROUGE | + 0,2 |

PACKAGING

L: 455 mm
D: 310 mm
H: 75 mm

4,4 kg

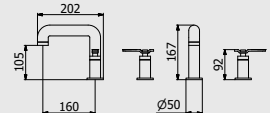

PORTATE | WATER FLOW | DÉBIT D'EAU

| | | |
|---------|---------|---------|
| 1 BAR | 2 BAR | 3 BAR |
| 3,3 l/m | 4,4 l/m | 4,5 l/m |

ARTICLE | ARTICOLO | ARTICLE

B2300



Exposed parts for manual wall mixer

Set di parti esterne per miscelatore a parete ad una via
Partie extérieure pour mitigeur encastré à une voie

| CODE / COEFFICIENT CODICE / COEFFICIENTE | COEFFICIENTE CODE / COEFFICIENT |
|--|-----------------------------------|
| CC EB2300CC | 6,0 |
| SS EB2300SS | 7,5 |
| ON EB2300ON | 6,0 |
| NP EB2300NP | 7,2 |
| CF EB2300CF | 9,0 |
| CS EB2300CS | 9,6 |
| II EB2300II | 9,0 |
| IS EB2300IS | 9,6 |
| RS EB2300RS | 9,0 |
| SR EB2300SR | 9,6 |
| OO EB2300OO | 9,0 |
| OS EB2300OS | 9,6 |
| _6 LEVA ROSSA RED LEVER LEVIER ROUGE | + 0,1 |

PACKAGING

L: 150 mm
D: 190 mm
H: 98 mm

1,4 kg

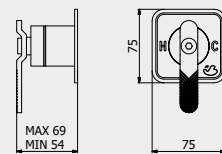

PORTATE | WATER FLOW | DÉBIT D'EAU

| | | |
|----------|----------|--------|
| 1 BAR | 2 BAR | 3 BAR |
| 11,5 l/m | 16,3 l/m | 20 l/m |

Built-in body to be purchased separately

Corpo incasso da acquistare separatamente

Corps intégré à acheter séparément



CODICE | CODE | CODE

INC300XXXN_19

COEFFICIENTE | COEFFICIENTE | COEFFICIENT

1,8

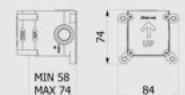

ARTICLE | ARTICOLO | ARTICLE

B2310



Exposed parts for manual wall mixer with two ways diverter
Miscelatore doccia a parete con deviatore due vie
Mitigeur douche mural deux voies avec inverseur

CODE / COEFFICIENT | CODICE /
COEFFICIENTE | CODE / COEFFICIENT

| | | |
|----|----------|------|
| CC | EB2310CC | 8,8 |
| SS | EB2310SS | 11,0 |
| ON | EB2310ON | 8,8 |
| NP | EB2310NP | 10,6 |
| CF | EB2310CF | 13,2 |
| CS | EB2310CS | 14,1 |
| II | EB2310II | 13,2 |
| IS | EB2310IS | 14,1 |
| RS | EB2310RS | 13,2 |
| SR | EB2310SR | 14,1 |
| OO | EB2310OO | 13,2 |
| OS | EB2310OS | 14,1 |

PACKAGING

L: 150 mm
D: 190 mm
H: 98 mm

2,1 kg

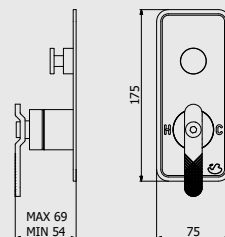

PORTATE | WATER FLOW | DÉBIT D'EAU

| | | |
|---------|----------|--------|
| 1 BAR | 2 BAR | 3 BAR |
| 9,2 l/m | 12,8 l/m | 16 l/m |

Built-in body to be purchased separately

Corpo incasso da acquistare separatamente

Corps intégré à acheter séparément



CODICE | CODE | CODE

INC310XXXN_19

COEFFICIENT | COEFFICIENTE | COEFFICIENT

3,3

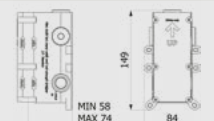

ARTICLE | ARTICOLO | ARTICLE

B2312



Exposed parts for manual wall mixer with three ways diverter
Set di parti esterne per miscelatore a parete a tre vie
Mitigeur douche mural trois voies avec inverseur

CODE / COEFFICIENT | CODICE /
COEFFICIENTE | CODE / COEFFICIENT

| | | |
|----|----------|------|
| CC | EB2312CC | 10,2 |
| SS | EB2312SS | 12,7 |
| ON | EB2312ON | 10,2 |
| NP | EB2312NP | 12,2 |
| CF | EB2312CF | 15,3 |
| CS | EB2312CS | 16,3 |
| II | EB2312II | 15,3 |
| IS | EB2312IS | 16,3 |
| RS | EB2312RS | 15,3 |
| SR | EB2312SR | 16,3 |
| OO | EB2312OO | 15,3 |
| OS | EB2312OS | 16,3 |

PACKAGING

L: 150 mm
D: 190 mm
H: 98 mm

2,2 kg

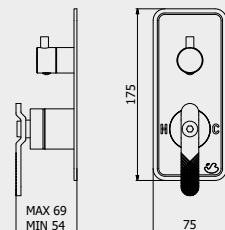

PORTATE | WATER FLOW | DÉBIT D'EAU

| | | |
|---------|----------|----------|
| 1 BAR | 2 BAR | 3 BAR |
| 8,3 l/m | 11,7 l/m | 14,3 l/m |

Built-in body to be purchased separately

Corpo incasso da acquistare separatamente

Corps intégré à acheter séparément



CODICE | CODE | CODE

INC312XXXN_19

COEFFICIENT | COEFFICIENTE | COEFFICIENT

3,3

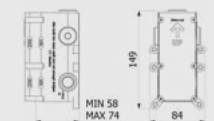

ARTICLE | ARTICOLO | ARTICLE

B2313



Exposed parts for manual wall mixer with 2 ways with shower kit
Set di parti esterne per miscelatore a parete a due vie completo di kit doccia
Partie extérieure pour mitigeur encastré à deux voies avec douchette

CODE / COEFFICIENT | CODICE /
COEFFICIENTE | CODE / COEFFICIENT

| | | |
|----|----------|------|
| CC | EB2313CC | 14,4 |
| SS | EB2313SS | 18,0 |
| ON | EB2313ON | 14,4 |
| NP | EB2313NP | 17,3 |
| CF | EB2313CF | 21,6 |
| CS | EB2313CS | 23,0 |
| II | EB2313II | 21,6 |
| IS | EB2313IS | 23,0 |
| RS | EB2313RS | 21,6 |
| SR | EB2313SR | 23,0 |
| OO | EB2313OO | 21,6 |
| OS | EB2313OS | 23,0 |

PACKAGING

L: 370 mm
D: 270 mm
H: 80 mm

2,8 kg

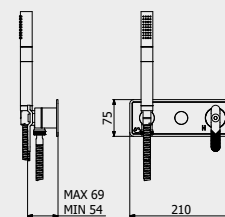

PORTATE | WATER FLOW | DÉBIT D'EAU

| | | |
|--------|----------|----------|
| 1 BAR | 2 BAR | 3 BAR |
| 10 l/m | 14,1 l/m | 17,2 l/m |

Built-in body to be purchased separately

Corpo incasso da acquistare separatamente

Corps intégré à acheter séparément



CODICE | CODE | CODE

INC313XXXN_19

COEFFICIENT | COEFFICIENTE | COEFFICIENT

3,6



ARTICLE | ARTICOLO | ARTICLE

B2314



Exposed parts for manual wall mixer with 3 ways with shower kit
Set di parti esterne per miscelatore a parete a tre vie completo di kit doccia
Partie extérieure pour mitigeur encastré à trois voies avec douchette

| CODE / COEFFICIENT | CODICE / COEFFICIENTE | |
|--------------------|---------------------------------------|-------|
| CC | EB2314CC | 15,8 |
| SS | EB2314SS | 19,8 |
| ON | EB2314ON | 15,8 |
| NP | EB2314NP | 19,0 |
| CF | EB2314CF | 23,7 |
| CS | EB2314CS | 25,3 |
| II | EB2314II | 23,7 |
| IS | EB2314IS | 25,3 |
| RS | EB2314RS | 23,7 |
| SR | EB2314SR | 25,3 |
| OO | EB2314OO | 23,7 |
| OS | EB2314OS | 25,3 |
| _6 | LEVA ROSSA RED LEVER LEVIER ROUGE | + 0,1 |

PACKAGING
L: 370 mm
D: 270 mm
H: 80 mm
2,8 kg

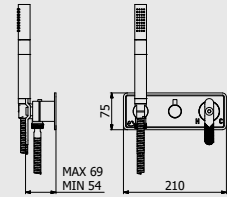

PORTATE | WATER FLOW | DÉBIT D'EAU

| | | |
|---------|----------|----------|
| 1 BAR | 2 BAR | 3 BAR |
| 8,3 l/m | 11,7 l/m | 14,3 l/m |

Built-in body to be purchased separately
Corpo incasso da acquistare separatamente
Corps intégré à acheter séparément



CODICE | CODE | CODE

INC314XXXN_19

COEFFICIENTE | COEFFICIENTE | COEFFICIENT

3,7



ARTICLE | ARTICOLO | ARTICLE

B1400



Two holes wall mounted shower
Coppia di rubinetti a parete per doccia una via
Mélangeur deux trous douche

| CODE / COEFFICIENT | CODICE / COEFFICIENTE | |
|--------------------|---------------------------------------|-------|
| CC | B1400CC | 6,8 |
| SS | B1400SS | 8,5 |
| ON | B1400ON | 6,8 |
| NP | B1400NP | 8,2 |
| CF | B1400CF | 10,2 |
| CS | B1400CS | 10,9 |
| II | B1400II | 10,2 |
| IS | B1400IS | 10,9 |
| RS | B1400RS | 10,2 |
| SR | B1400SR | 10,9 |
| OO | B1400OO | 10,2 |
| OS | B1400OS | 10,9 |
| _6 | LEVA ROSSA RED LEVER LEVIER ROUGE | + 0,2 |

PACKAGING
L: 340 mm
D: 180 mm
H: 70 mm
2,3 kg

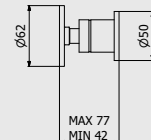

PORTATE | WATER FLOW | DÉBIT D'EAU

| | | |
|--------|--------|----------|
| 1 BAR | 2 BAR | 3 BAR |
| 28 l/m | 40 l/m | 49,3 l/m |

ARTICLE | ARTICOLO | ARTICLE

B2400



Two holes wall mounted shower
Coppia di rubinetti a parete per doccia una via
Mélangeur deux trous douche

| CODE / COEFFICIENT | CODICE / COEFFICIENTE | |
|--------------------|---------------------------------------|-------|
| CC | B2400CC | 6,8 |
| SS | B2400SS | 8,5 |
| ON | B2400ON | 6,8 |
| NP | B2400NP | 8,2 |
| CF | B2400CF | 10,2 |
| CS | B2400CS | 10,9 |
| II | B2400II | 10,2 |
| IS | B2400IS | 10,9 |
| RS | B2400RS | 10,2 |
| SR | B2400SR | 10,9 |
| OO | B2400OO | 10,2 |
| OS | B2400OS | 10,9 |
| _6 | LEVA ROSSA RED LEVER LEVIER ROUGE | + 0,2 |

PACKAGING
L: 340 mm
D: 180 mm
H: 70 mm
2,3 kg

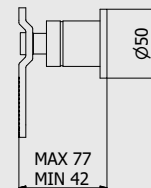

PORTATE | WATER FLOW | DÉBIT D'EAU

| | | |
|--------|--------|----------|
| 1 BAR | 2 BAR | 3 BAR |
| 28 l/m | 40 l/m | 49,3 l/m |

ARTICLE | ARTICOLO | ARTICLE

B1410



Three holes wall mounted shower with two ways diverter

Tre rubinetti a parete per doccia con deviatore a due vie

Melangeur trois trous douche avec inverseur deux voies

CODE / COEFFICIENT | CODICE /
COEFFICIENTE | CODE / COEFFICIENT

| | | |
|----|---------|------|
| CC | B1410CC | 11,7 |
| SS | B1410SS | 14,6 |
| ON | B1410ON | 11,7 |
| NP | B1410NP | 14,0 |
| CF | B1410CF | 17,6 |
| CS | B1410CS | 18,7 |
| II | B1410II | 17,6 |
| IS | B1410IS | 18,7 |
| RS | B1410RS | 17,6 |
| SR | B1410SR | 18,7 |
| OO | B1410OO | 17,6 |
| OS | B1410OS | 18,7 |

-6 LEVA ROSSA | RED
LEVER | LEVIER ROUGE + 0,3

PACKAGING

L: 240 mm
D: 215 mm
H: 110 mm

2,8 kg

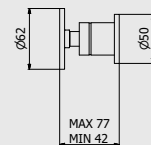

PORTATE | WATER FLOW | DÉBIT D'EAU

| | 1 BAR | 2 BAR | 3 BAR |
|---|----------|----------|----------|
| Uscita principale / Main outlet / Sortie principale | 16 l/m | 22,4 l/m | 27,5 l/m |
| Doccetta / Handshower / Douchette | 14,7 l/m | 20,6 l/m | 25,3 l/m |

ARTICLE | ARTICOLO | ARTICLE

B2410



Three holes wall mounted shower with two ways diverter

Tre rubinetti a parete per doccia con deviatore a due vie

Melangeur trois trous douche avec inverseur deux voies

CODE / COEFFICIENT | CODICE /
COEFFICIENTE | CODE / COEFFICIENT

| | | |
|----|---------|------|
| CC | B2410CC | 11,7 |
| SS | B2410SS | 14,6 |
| ON | B2410ON | 11,7 |
| NP | B2410NP | 14,0 |
| CF | B2410CF | 17,6 |
| CS | B2410CS | 18,7 |
| II | B2410II | 17,6 |
| IS | B2410IS | 18,7 |
| RS | B2410RS | 17,6 |
| SR | B2410SR | 18,7 |
| OO | B2410OO | 17,6 |
| OS | B2410OS | 18,7 |

-6 LEVA ROSSA | RED
LEVER | LEVIER ROUGE + 0,3

PACKAGING

L: 240 mm
D: 215 mm
H: 110 mm

2,8 kg

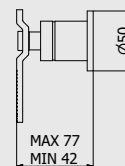

PORTATE | WATER FLOW | DÉBIT D'EAU

| | 1 BAR | 2 BAR | 3 BAR |
|--|----------|----------|----------|
| Acqua miscelata / Mixed water / Eau mélangée | 16 l/m | 22,4 l/m | 27,5 l/m |
| Doccetta / Handshower / Douchette | 14,7 l/m | 20,6 l/m | 25,3 l/m |

ARTICLE | ARTICOLO | ARTICLE

B1800



Bold thermostatic shower column with shower kit

Colonna doccia Bold termostatica con kit doccia

Colonne de douche thermostatique avec kit douche

CODE / COEFFICIENT | CODICE /
COEFFICIENTE | CODE / COEFFICIENT

| | | |
|----|---------|------|
| CC | B2800CC | 53,7 |
| SS | B2800SS | 67,1 |
| ON | B2800ON | 53,7 |
| NP | B2800NP | 64,4 |
| CF | B2800CF | 80,6 |
| CS | B2800CS | 85,9 |
| II | B2800II | 80,6 |
| IS | B2800IS | 85,9 |
| RS | B2800RS | 80,6 |
| SR | B2800SR | 85,9 |
| OO | B2800OO | 80,6 |
| OS | B2800OS | 85,9 |

-6 LEVA ROSSA | RED
LEVER | LEVIER ROUGE + 0,2

PACKAGING

L: 800 mm
D: 500 mm
H: 180 mm

12,1 kg

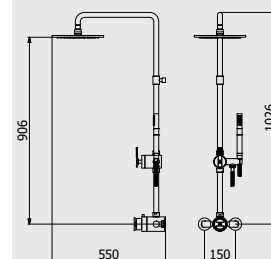

PORTATE | WATER FLOW | DÉBIT D'EAU

| | 1 BAR | 2 BAR | 3 BAR |
|--|----------|---------|----------|
| Acqua miscelata / Mixed water / Eau mélangée | 10,7 l/m | 15 l/m | 18,5 l/m |
| Doccetta / Handshower / Douchette | 6,7 l/m | 9,6 l/m | 11,9 l/m |



ARTICLE | ARTICOLO | ARTICLE

B1396



Five holes deck mounted bath filler with shower kit

Bordo vasca cinque fori con deviatore e kit doccia

Bain/douche cinq trous avec inverseur et Kit Douche

| CODE / COEFFICIENT | CODICE / COEFFICIENTE | |
|--------------------|---------------------------------------|-------|
| CC | B1396CC | 25,5 |
| SS | B1396SS | 31,9 |
| ON | B1396ON | 25,5 |
| NP | B1396NP | 30,6 |
| CF | B1396CF | 38,3 |
| CS | B1396CS | 40,8 |
| II | B1396II | 38,3 |
| IS | B1396IS | 40,8 |
| RS | B1396RS | 38,3 |
| SR | B1396SR | 40,8 |
| OO | B1396OO | 38,3 |
| OS | B1396OS | 40,8 |
| _6 | LEVA ROSSA RED LEVER LEVIER ROUGE | + 0,3 |

PACKAGING

L: 675 mm
D: 320 mm
H: 80 mm

5,9 kg

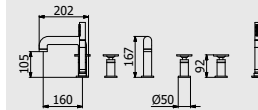

PORTATE | WATER FLOW | DÉBIT D'EAU

| | 1 BAR | 2 BAR | 3 BAR |
|--|----------|----------|----------|
| Acqua miscelata / Mixed water / Eau mélangée | 13,6 l/m | 19,1 l/m | 3,6 l/m |
| Solo calda / Only hot / Seulement chaud | 9,1 l/m | 12,9 l/m | 15,9 l/m |
| Doccetta / Handshower / Douchette | 6,8 l/m | 10 l/m | 12,5 l/m |

ARTICLE | ARTICOLO | ARTICLE

B2396



Five holes deck mounted bath filler with shower kit

Bordo vasca cinque fori con deviatore e kit doccia

Bain/douche cinq trous avec inverseur et Kit Douche

| CODE / COEFFICIENT | CODICE / COEFFICIENTE | |
|--------------------|---------------------------------------|-------|
| CC | B2396CC | 25,5 |
| SS | B2396SS | 31,9 |
| ON | B2396ON | 25,5 |
| NP | B2396NP | 30,6 |
| CF | B2396CF | 38,3 |
| CS | B2396CS | 40,8 |
| II | B2396II | 38,3 |
| IS | B2396IS | 40,8 |
| RS | B2396RS | 38,3 |
| SR | B2396SR | 40,8 |
| OO | B2396OO | 38,3 |
| OS | B2396OS | 40,8 |
| _6 | LEVA ROSSA RED LEVER LEVIER ROUGE | + 0,3 |

PACKAGING

L: 675 mm
D: 320 mm
H: 80 mm

5,9 kg

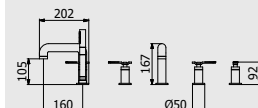

PORTATE | WATER FLOW | DÉBIT D'EAU

| | 1 BAR | 2 BAR | 3 BAR |
|--|----------|----------|----------|
| Acqua miscelata / Mixed water / Eau mélangée | 13,6 l/m | 19,1 l/m | 23,6 l/m |
| Solo calda / Only hot / Seulement chaud | 9,1 l/m | 12,9 l/m | 15,9 l/m |
| Doccetta / Handshower / Douchette | 6,8 l/m | 10 l/m | 12,5 l/m |

ARTICLE | ARTICOLO | ARTICLE

B1397



4 holes bath filler with overflow outlet connection, diverter and shower kit

Bordo vasca 4 fori per colonna riempimento con deviatore e kit doccia

Bain/douche 4 trous avec inverseur et Kit Douche pour remplissage ETP

| CODE / COEFFICIENT | CODICE / COEFFICIENTE | |
|--------------------|---------------------------------------|-------|
| CC | B1397CC | 18,6 |
| SS | B1397SS | 23,3 |
| ON | B1397ON | 18,6 |
| NP | B1397NP | 22,3 |
| CF | B1397CF | 27,9 |
| CS | B1397CS | 29,8 |
| II | B1397II | 27,9 |
| IS | B1397IS | 29,8 |
| RS | B1397RS | 27,9 |
| SR | B1397SR | 29,8 |
| OO | B1397OO | 27,9 |
| OS | B1397OS | 29,8 |
| _6 | LEVA ROSSA RED LEVER LEVIER ROUGE | + 0,3 |

PACKAGING

L: 455 mm
D: 310 mm
H: 75 mm

4,7 kg

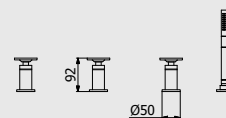

PORTATE | WATER FLOW | DÉBIT D'EAU

| | 1 BAR | 2 BAR | 3 BAR |
|--|---------|--------|----------|
| Acqua miscelata / Mixed water / Eau mélangée | 16 l/m | 23 l/m | 28 l/m |
| Doccetta / Handshower / Douchette | 6,8 l/m | 10 l/m | 12,5 l/m |

ARTICLE | ARTICOLO | ARTICLE

B2397



4 holes bath filler with overflow outlet connection, diverter and shower kit
Bordo vasca 4 fori per colonna riempimento con deviatore e kit doccia
Bain/douche 4 trous avec inverseur et Kit Douche pour remplissage ETP

CODE / COEFFICIENT | CODICE /
COEFFICIENTE | CODE / COEFFICIENT

| | | |
|------|---------|------|
| ● CC | B2397CC | 18,6 |
| ● SS | B2397SS | 23,3 |
| ● ON | B2397ON | 18,6 |
| ● NP | B2397NP | 22,3 |
| ● CF | B2397CF | 27,9 |
| ● CS | B2397CS | 29,8 |
| ● II | B2397II | 27,9 |
| ● IS | B2397IS | 29,8 |
| ● RS | B2397RS | 27,9 |
| ● SR | B2397SR | 29,8 |
| ● OO | B2397OO | 27,9 |
| ● OS | B2397OS | 29,8 |

PACKAGING

L: 455 mm
D: 310 mm
H: 75 mm

4,7 kg

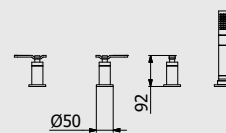

_6 LEVA ROSSA | RED
LEVER | LEVIER ROUGE + 0,3

PORTATE | WATER FLOW | DÉBIT D'EAU

| | 1 BAR | 2 BAR | 3 BAR |
|--|---------|--------|----------|
| Acqua miscelata / Mixed water / Eau mélangée | 16 l/m | 23 l/m | 28 l/m |
| Doccetta / Handshower / Douchette | 6,8 l/m | 10 l/m | 12,5 l/m |

ARTICLE | ARTICOLO | ARTICLE

B1398



Five holes wall mounted bath filler with shower kit
Bordo vasca a parete cinque fori con deviatore e kit doccia
Bain/douche cinq trous avec inverseur et Kit Douche

CODE / COEFFICIENT | CODICE /
COEFFICIENTE | CODE / COEFFICIENT

| | | |
|------|---------|------|
| ● CC | B1398CC | 22,1 |
| ● SS | B1398SS | 27,6 |
| ● ON | B1398ON | 22,1 |
| ● NP | B1398NP | 26,5 |
| ● CF | B1398CF | 33,2 |
| ● CS | B1398CS | 35,4 |
| ● II | B1398II | 33,2 |
| ● IS | B1398IS | 35,4 |
| ● RS | B1398RS | 33,2 |
| ● SR | B1398SR | 35,4 |
| ● OO | B1398OO | 33,2 |
| ● OS | B1398OS | 35,4 |

PACKAGING

L: 470 mm
D: 290 mm
H: 160 mm

4,9 kg

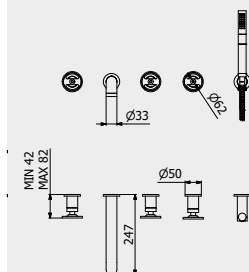

_6 LEVA ROSSA | RED
LEVER | LEVIER ROUGE + 0,3

PORTATE | WATER FLOW | DÉBIT D'EAU

| | 1 BAR | 2 BAR | 3 BAR |
|--|----------|----------|----------|
| Acqua miscelata / Mixed water / Eau mélangée | 12,3 l/m | 17,5 l/m | 21,8 l/m |
| Solo calda / Only hot / Seulement chaud | 9,2 l/m | 12,9 l/m | 16 l/m |
| Doccetta / Handshower / Douchette | 8,1 l/m | 12,5 l/m | 14 l/m |

ARTICLE | ARTICOLO | ARTICLE

B2398



Five holes wall mounted bath filler with shower kit
Bordo vasca a parete cinque fori con deviatore e kit doccia
Bain/douche cinq trous avec inverseur et Kit Douche

CODE / COEFFICIENT | CODICE /
COEFFICIENTE | CODE / COEFFICIENT

| | | |
|------|---------|------|
| ● CC | B2398CC | 22,1 |
| ● SS | B2398SS | 27,6 |
| ● ON | B2398ON | 22,1 |
| ● NP | B2398NP | 26,5 |
| ● CF | B2398CF | 33,2 |
| ● CS | B2398CS | 35,4 |
| ● II | B2398II | 33,2 |
| ● IS | B2398IS | 35,4 |
| ● RS | B2398RS | 33,2 |
| ● SR | B2398SR | 35,4 |
| ● OO | B2398OO | 33,2 |
| ● OS | B2398OS | 35,4 |

PACKAGING

L: 470 mm
D: 290 mm
H: 160 mm

4,9 kg

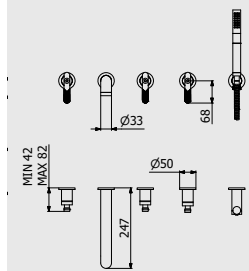

_6 LEVA ROSSA | RED
LEVER | LEVIER ROUGE + 0,3

PORTATE | WATER FLOW | DÉBIT D'EAU

| | 1 BAR | 2 BAR | 3 BAR |
|--|----------|----------|----------|
| Acqua miscelata / Mixed water / Eau mélangée | 12,3 l/m | 17,5 l/m | 21,8 l/m |
| Solo calda / Only hot / Seulement chaud | 9,2 l/m | 12,9 l/m | 16 l/m |
| Doccetta / Handshower / Douchette | 8,1 l/m | 11,5 l/m | 14 l/m |



ARTICLE | ARTICOLO | ARTICLE

B1700



Free-standing two columns bath filler with shower kit
Bordo vasca da terra a doppia colonna con kit doccia
Mélangeur bain/douche complet avec alimentation sol

| CODE / COEFFICIENT | CODICE / COEFFICIENTE | |
|--------------------|-----------------------|------|
| CC | B1700CC | 47,1 |
| SS | B1700SS | 58,9 |
| ON | B1700ON | 47,1 |
| NP | B1700NP | 56,5 |
| CF | B1700CF | 70,7 |
| CS | B1700CS | 75,4 |
| II | B1700II | 70,7 |
| IS | B1700IS | 75,4 |
| RS | B1700RS | 70,7 |
| SR | B1700SR | 75,4 |
| OO | B1700OO | 70,7 |
| OS | B1700OS | 75,4 |

6 LEVA ROSSA | RED LEVER | LEVIER ROUGE + 0,2

PACKAGING

L: 1020 mm
D: 480 mm
H: 120 mm

12,8 kg

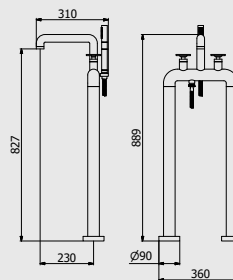

PORTATE | WATER FLOW | DÉBIT D'EAU

| | 1 BAR | 2 BAR | 3 BAR |
|--|----------|----------|----------|
| Acqua miscelata / Mixed water / Eau mélangée | 24,5 l/m | 34,6 l/m | 43 l/m |
| Solo calda / Only hot / Seulement chaud | 19,8 l/m | 28,4 l/m | 34,8 l/m |
| Doccetta / Handshower / Douchette | 7,9 l/m | 11,4 l/m | 14,2 l/m |

ARTICLE | ARTICOLO | ARTICLE

B2700



Free-standing two columns bath filler with shower kit
Bordo vasca da terra a doppia colonna con kit doccia
Mélangeur bain/douche complet avec alimentation sol

| CODE / COEFFICIENT | CODICE / COEFFICIENTE | |
|--------------------|-----------------------|------|
| CC | B2700CC | 47,1 |
| SS | B2700SS | 58,9 |
| ON | B2700ON | 47,1 |
| NP | B2700NP | 56,5 |
| CF | B2700CF | 70,7 |
| CS | B2700CS | 75,4 |
| II | B2700II | 70,7 |
| IS | B2700IS | 75,4 |
| RS | B2700RS | 70,7 |
| SR | B2700SR | 75,4 |
| OO | B2700OO | 70,7 |
| OS | B2700OS | 75,4 |

6 LEVA ROSSA | RED LEVER | LEVIER ROUGE + 0,2

PACKAGING

L: 1020 mm
D: 480 mm
H: 120 mm

12,8 kg

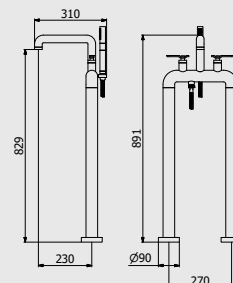

PORTATE | WATER FLOW | DÉBIT D'EAU

| | 1 BAR | 2 BAR | 3 BAR |
|--|----------|----------|----------|
| Acqua miscelata / Mixed water / Eau mélangée | 24,5 l/m | 34,6 l/m | 43 l/m |
| Solo calda / Only hot / Seulement chaud | 19,8 l/m | 28,4 l/m | 34,8 l/m |
| Doccetta / Handshower / Douchette | 7,9 l/m | 11,4 l/m | 14,2 l/m |

ARTICLE | ARTICOLO | ARTICLE

B2022



Duplex BOLD

Duplex BOLD

Duplex BOLD

| CODE / COEFFICIENT | CODICE / COEFFICIENTE | |
|--------------------|-----------------------|------|
| CC | B2022CC | 6,3 |
| SS | B2022SS | 7,9 |
| ON | B2022ON | 6,3 |
| NP | B2022NP | 7,9 |
| CF | B2022CF | 9,5 |
| CS | B2022CS | 10,1 |
| II | B2022II | 9,5 |
| IS | B2022IS | 10,1 |
| RS | B2022RS | 9,5 |
| SR | B2022SR | 10,1 |
| OO | B2022OO | 9,5 |
| OS | B2022OS | 10,1 |

PACKAGING

L: 340 mm
D: 180 mm
H: 70 mm

1,0 kg

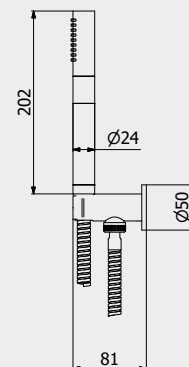

ARTICLE | ARTICOLO | ARTICLE

B2706



Exposed parts for bidet spray complete with mixer

Set di parti esterne per Idroscopino igienico con miscelatore

Partie extérieure pour douchette hygiénique avec mitigeur

CODE / COEFFICIENT | CODICE /
COEFFICIENTE | CODE / COEFFICIENT

| | | |
|----|----------|------|
| CC | EB2706CC | 12,5 |
| SS | EB2706SS | 15,6 |
| ON | EB2706ON | 12,5 |
| NP | EB2706NP | 15,0 |
| CF | EB2706CF | 18,8 |
| CS | EB2706CS | 20,0 |
| II | EB2706II | 18,8 |
| IS | EB2706IS | 20,0 |
| RS | EB2706RS | 18,8 |
| SR | EB2706SR | 20,0 |
| OO | EB2706OO | 18,8 |
| OS | EB2706OS | 20,0 |

-6 LEVA ROSSA | RED
LEVER | LEVIER ROUGE + 0,1

PACKAGING

L: 370 mm
D: 270 mm
H: 80 mm

2,8 kg

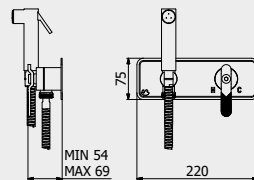

PORTATE | WATER FLOW | DÉBIT D'EAU

| | | |
|---------|---------|-------|
| 1 BAR | 2 BAR | 3 BAR |
| 2,3 l/m | 3,2 l/m | 4 l/m |

Built-in body to be purchased
separatelyCorpo incasso da acquistare
separatamenteCorps intégré à acheter
séparément

CODICE | CODE | CODE

INC206XXXN_19

COEFFICIENT | COEFFICIENTE | COEFFICIENT

2,9

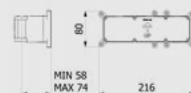

ARTICLE | ARTICOLO | ARTICLE

B1370



Single Lever kitchen mixer

Miscelatore lavello monoforo

Évier de cuisine

CODE / COEFFICIENT | CODICE /
COEFFICIENTE | CODE / COEFFICIENT

| | | |
|----|---------|------|
| CC | B1370CC | 14 |
| SS | B1370SS | 17,5 |
| ON | B1370ON | 14,0 |
| NP | B1370NP | 16,8 |
| CF | B1370CF | 21,0 |
| CS | B1370CS | 22,4 |
| II | B1370II | 21,0 |
| IS | B1370IS | 22,4 |
| RS | B1370RS | 21,0 |
| SR | B1370SR | 22,4 |
| OO | B1370OO | 21,0 |
| OS | B1370OS | 22,4 |

-6 LEVA ROSSA | RED
LEVER | LEVIER ROUGE + 0,1

PACKAGING

L: 400 mm
D: 250 mm
H: 140 mm

3,5 kg

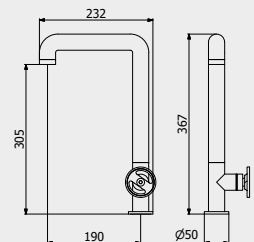

PORTATE | WATER FLOW | DÉBIT D'EAU

| | | |
|-------|---------|---------|
| 1 BAR | 2 BAR | 3 BAR |
| 3 l/m | 4,4 l/m | 4,5 l/m |

ARTICLE | ARTICOLO | ARTICLE

B2370



Single Lever kitchen mixer

Miscelatore lavello monoforo

Évier de cuisine

CODE / COEFFICIENT | CODICE /
COEFFICIENTE | CODE / COEFFICIENT

| | | |
|----|---------|------|
| CC | B2370CC | 14 |
| SS | B2370SS | 17,5 |
| ON | B2370ON | 14,0 |
| NP | B2370NP | 16,8 |
| CF | B2370CF | 21,0 |
| CS | B2370CS | 22,4 |
| II | B2370II | 21,0 |
| IS | B2370IS | 22,4 |
| RS | B2370RS | 21,0 |
| SR | B2370SR | 22,4 |
| OO | B2370OO | 21,0 |
| OS | B2370OS | 22,4 |

-6 LEVA ROSSA | RED
LEVER | LEVIER ROUGE + 0,1

PACKAGING

L: 400 mm
D: 250 mm
H: 140 mm

3,5 kg

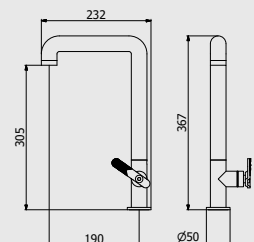

PORTATE | WATER FLOW | DÉBIT D'EAU

| | | |
|-------|---------|---------|
| 1 BAR | 2 BAR | 3 BAR |
| 3 l/m | 4,4 l/m | 4,5 l/m |



OFFICINA / ACCESSORIES COLLECTION



ARTICLE | ARTICOLO | ARTICLE

OF006



PACKAGING

L: 330 mm
D: 90 mm
H: 40 mm

0,15 kg

Towel holder
Porta salvietta
Porte-serviette

CODE / COEFFICIENT | CODICE / COEFFICIENTE | CODE / COEFFICIENT

| | | | |
|--|----|---------|-----|
| | CC | OF006CC | 2,4 |
| | SS | OF006SS | 3,0 |
| | ON | OF006ON | 2,4 |
| | BO | OF006BO | 2,9 |
| | NP | OF006NP | 2,9 |
| | CF | OF006CF | 3,6 |
| | CS | OF006CS | 3,8 |
| | II | OF006II | 3,6 |
| | IS | OF006IS | 3,8 |
| | RS | OF006RS | 3,6 |
| | SR | OF006SR | 3,8 |
| | OO | OF006OO | 3,6 |
| | OS | OF006OS | 3,8 |

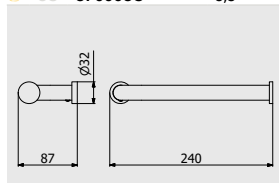

ARTICLE | ARTICOLO | ARTICLE

OF011



PACKAGING

L: 410 mm
D: 195 mm
H: 100 mm

0,3 kg

Toilet paper holder
Porta rotolo
Porte rouleaux de toilette

CODE / COEFFICIENT | CODICE / COEFFICIENTE | CODE / COEFFICIENT

| | | | |
|--|----|---------|-----|
| | CC | OF011CC | 2,1 |
| | SS | OF011SS | 2,6 |
| | ON | OF011ON | 2,1 |
| | BO | OF011BO | 2,6 |
| | NP | OF011NP | 2,6 |
| | CF | OF011CF | 3,2 |
| | CS | OF011CS | 3,4 |
| | II | OF011II | 3,2 |
| | IS | OF011IS | 3,4 |
| | RS | OF011RS | 3,2 |
| | SR | OF011SR | 3,4 |
| | OO | OF011OO | 3,2 |
| | OS | OF011OS | 3,4 |

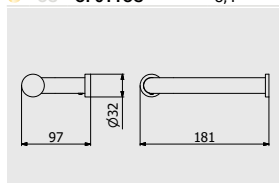

ARTICLE | ARTICOLO | ARTICLE

OF012



PACKAGING

L: 410 mm
D: 195 mm
H: 100 mm

0,3 kg

Toilet brush holder
Porta scopino da terra
Porte balayette au sol

CODE / COEFFICIENT | CODICE / COEFFICIENTE | CODE / COEFFICIENT

| | | | |
|--|----|---------|------|
| | CC | OF012CC | 6,9 |
| | SS | OF012SS | 8,6 |
| | ON | OF012ON | 6,9 |
| | BO | OF012BO | 8,6 |
| | NP | OF012NP | 8,6 |
| | CF | OF012CF | 10,4 |
| | CS | OF012CS | 11,0 |
| | II | OF012II | 10,4 |
| | IS | OF012IS | 11,0 |
| | RS | OF012RS | 10,4 |
| | SR | OF012SR | 11,0 |
| | OO | OF012OO | 10,4 |
| | OS | OF012OS | 11,0 |

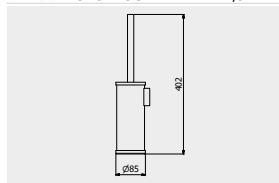

ARTICLE | ARTICOLO | ARTICLE

OF008



PACKAGING

L: 60 mm
D: 60 mm
H: 60 mm

0,08 kg

Robe Hook

Appendino a parete
Cintre

CODE / COEFFICIENT | CODICE / COEFFICIENTE | CODE / COEFFICIENT

| | | | |
|--|----|---------|-----|
| | CC | OF008CC | 1,0 |
| | SS | OF008SS | 1,3 |
| | ON | OF008ON | 1,0 |
| | BO | OF006BO | 1,3 |
| | NP | OF008NP | 1,3 |
| | CF | OF008CF | 1,5 |
| | CS | OF008CS | 1,6 |
| | II | OF008II | 1,5 |
| | IS | OF008IS | 1,6 |
| | RS | OF008RS | 1,5 |
| | SR | OF008SR | 1,6 |
| | OO | OF008OO | 1,5 |
| | OS | OF008OS | 1,6 |

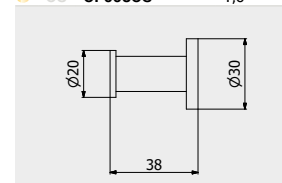

ARTICLE | ARTICOLO | ARTICLE

OF014



PACKAGING

L: 500 mm
D: 100 mm
H: 45 mm

0,4 kg

Towel holder

Porta salvietta
Porte-serviette

CODE / COEFFICIENT | CODICE / COEFFICIENTE | CODE / COEFFICIENT

| | | | |
|--|----|---------|-----|
| | CC | OF014CC | 3,7 |
| | SS | OF014SS | 4,6 |
| | ON | OF014ON | 3,7 |
| | BO | OF014BO | 4,6 |
| | NP | OF014NP | 4,6 |
| | CF | OF014CF | 5,6 |
| | CS | OF014CS | 5,9 |
| | II | OF014II | 5,6 |
| | IS | OF014IS | 5,9 |
| | RS | OF014RS | 5,6 |
| | SR | OF014SR | 5,9 |
| | OO | OF014OO | 5,6 |
| | OS | OF014OS | 5,9 |

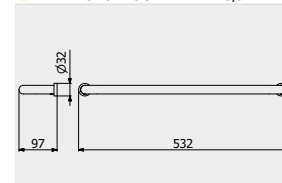

ARTICLE | ARTICOLO | ARTICLE

OF002



PACKAGING

L: 170 mm
D: 60 mm
H: 80 mm

0,6 kg

Soap dispenser holder

Porta dispenser sapone liquido
Porte distributeur de savon

CODE / COEFFICIENT | CODICE / COEFFICIENTE | CODE / COEFFICIENT

| | | | |
|--|----|---------|-----|
| | CC | OF002CC | 3,7 |
| | SS | OF002SS | 4,6 |
| | ON | OF002ON | 3,7 |
| | BO | OF002BO | 4,6 |
| | NP | OF002NP | 4,6 |
| | CF | OF002CF | 5,6 |
| | CS | OF002CS | 5,9 |
| | II | OF002II | 5,6 |
| | IS | OF002IS | 5,9 |
| | RS | OF002RS | 5,6 |
| | SR | OF002SR | 5,9 |
| | OO | OF002OO | 5,6 |
| | OS | OF002OS | 5,9 |

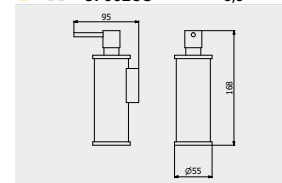

MARMO / MARMO L

Never can be two identical Marmo.

Non esisteranno mai due Marmo identici
Jamais il n'y aura deux Marmo identiques

A synthesis between eternity and current fashion, tradition and fantasy. The MARMO collection focuses on the quality of the raw material, carefully selected and processed in order to obtain a thin and resistant case, perfect in its cylindrical shape and original in its uniqueness.

The hand-made stone conceals inside an innovative compact mixer, which provides the highest technological performances in the slightest space.

Una sintesi di eternità e attualità, di tradizione e fantasia. La serie MARMO è incentrata sulla qualità della materia prima, attentamente selezionata e lavorata al fine di ottenere un involucro sottile e resistente, perfetto nella sua forma cilindrica e originale nella sua irripetibilità.

Lavorata a mano, la pietra nasconde al suo interno un miscelatore compatto innovativo, che in un minimo spazio fornisce le più alte performance tecnologiche.

Une synthèse entre éternité et modernité, tradition et fantaisie. La collection MARMO est axée sur la qualité de la matière première, soigneusement sélectionnée et traitée afin d'obtenir une enveloppe fin et résistante, parfaite dans sa forme cylindrique et originale dans sa unicité.

Ouvragée à la main, la pierre cache un mixeur compact innovant qui offre les meilleures performances technologiques dans le moindre espace.



CRYSTAL CLEAR
WATER



DOUBLE SPOUT



LEAD FREE



ZINC FREE





MARMO is a bathroom collection where the uniqueness of the stone and the unpredictable veins of the marble make every piece of the series unique: there can't be two identical MARMO.

Marmo è una collezione di rubinetti che sfrutta l'unicità della pietra e le sue venature imprevedibili: non esistono due MARMO identici, ogni elemento della collezione è in modo naturale un pezzo unico.

MARMO est la collection pour la salle de bain où l'unicité de la pierre et les veines imprévisibles du marbre font de chaque unité un pièce unique : jamais ne pourrait-il y avoir deux Marmo identiques.





MARMO is the result between the combination of industrial processes and the know-how of the best Italian artisans translated in to simple geometric shapes enriched with the intrinsic aesthetic of the material. The series comprehends different elegant products designed in several finishes; the marble parts are produced in white Carrara and black Marquina while the metal elements are made out of brass in chrome, white, black, gold, brushed nickel and gold rose finishes. This makes MARMO satisfying different needs, styles and tastes.

MARMO nasce dall'unione tra innovazione tecnologica e artigianato tradotta in forme essenziali e geometriche arricchite dall'estetica intrinseca del materiale. MARMO è una linea di prodotti elegante disegnata in diverse finiture; le parti in marmo sono realizzate in bianco Carrara o nero Marquina, mentre gli elementi metallici sono in ottone con finitura cromo, bianco, nero, oro, nickel spazzolato e oro rosa. Questo rende MARMO versatile e adattabile a un ampio numero di ambienti.

MARMO est le résultat d'une combinaison entre la production industrielle et le meilleur savoir-faire artisanal italien, traduit dans des formes géométriques simples, enrichies par la seule esthétique intrinsèque au matériel. La série comprend plusieurs produits élégants, conçus en plusieurs finitions ; les éléments en marbre sont fabriqués en Carrara blanc et Marquina noir, alors que les éléments métalliques sont ornés de finitions en laiton chromé blanc, noir, or, nickel brossé et rose doré. Tout ces éléments permettent à MARMO de satisfaire les besoins, les styles et les goûts les plus variés.

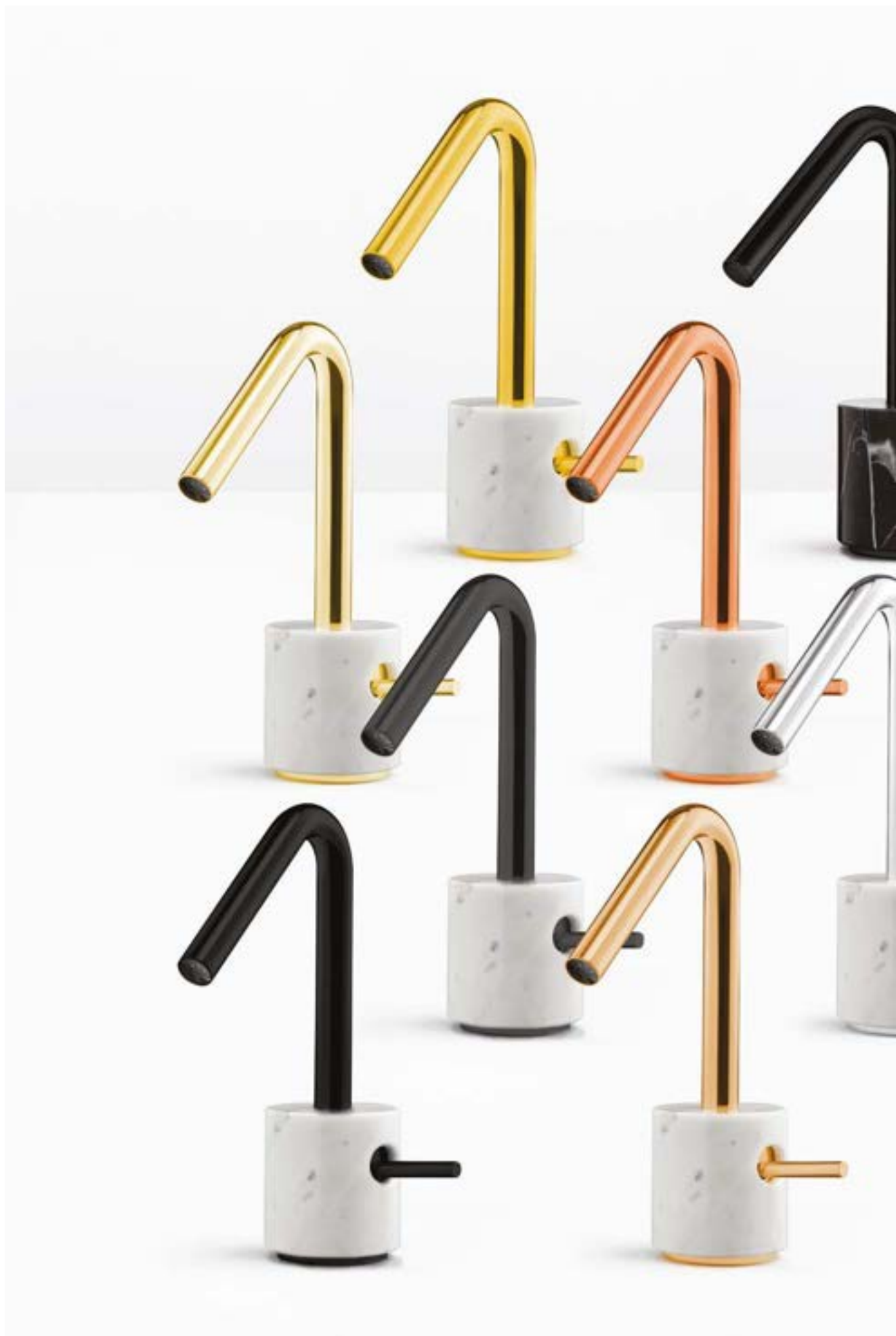





← MM200CC_1
Monohole washbasin mixer
Miscelatore lavabo monoforo
Mitigeur lavabo

→ MR202CC_1
Tall monohole washbasin mixer
Miscelatore lavabo monoforo alto
Mitigeur lavabo Haut

↘ MR306CC_2
Wall mounted widespread lavatory faucet
Rubinetto lavabo da incasso
Robinet de lavabo mural

Marmo





- MR220CC_2
Monohole bidet mixer
Miscelatore bidet monoforo
Mitigeur bidet

- ↙ MR392CC_1
Three holes washbasin set with low spout
Lavabo tre fori a bocca bassa
Lavabo trois trous bec bas

- ↘ MR209CC_2
Mono hole wall mounted washbasin mixer
Miscelatore lavabo a parete monoforo
Mitigeur lavabo mural monotrou

Marmo





- ← **MR300CC_19**
One way wall shower mixer
Miscelatore doccia a parete una via
Mitigeur douche mural une voie

- ↙ **MR706CC_19**
Exposed parts for bidet spray complete with mixer
Set di parti esterne per Idroscopino igienico con miscelatore
Partie extérieure pour douchette hygiénique avec mitigeur

- **MR313CC_20**
Two ways wall shower mixer with shower kit
Miscelatore doccia a parete con deviatore due vie e doccia integrato
Mitigeur douche mural deux voies avec inverseur et douchette encastrée







← MR320CC_1
Wall mounted spout
Bocca d'erogazione a parete
Bec de remplissage mural

→ EUA411CCNMR2
Thermostatic 4 ways
Termostatico 4 vie
Thermostatique 4 voies

↙ MR410CC_2
Three holes wall mounted shower with two
ways diverter
Tre rubinetti a parete per doccia con deviatore
a due vie
Melangeur trois trous douche avec inverseur
deux voies









← MR399CC_2
Free-standing bath filler with shower kit
 Bordo vasca da terra con kit doccia
 Bain douche complet alimentation au sol

↑ MR396CC_1
Five holes deck mounted bath filler with shower kit
 Bordo vasca cinque fori con deviatore e kit doccia
 Bain/douche cinq trous avec inverseur et kit douche

→ MR398CC_1
Five holes wall mounted bath filler with shower kit
 Bordo vasca a parete cinque fori con deviatore e kit doccia
 Bain/douche cinq trous avec inverseur et kit douche

- | | |
|---|--|
| A Hot water Acqua calda Eau chaude | D Diverter Deviatore Déviateur |
| B Spout Bocca d'erogazione Bec | E Hand shower Doccino Douchette |
| C Cold water Acqua fredda Eau froide | |







↑ MR031_2
MR031_1
Dish soap holder
Portasapone e posaogetti
Porte- savon

MR001_1
MR001_2
Soap-holder
Porta sapone
Porte savon

→ MR399CC_1
← Free-standing bath filler with shower kit
Bordo vasca da terra con kit doccia
Bain douche complet alimentation au sol

| | |
|---|--|
| A Hot water Acqua calda Eau chaude | C Diverter Deviatore Déviateur |
| B Cold water Acqua fredda Eau froide | D Hand shower Doccino Douchette |



ARTICLE | ARTICOLO | ARTICLE

MR200



Monohole washbasin mixer complete with drain

Miscelatore lavabo monoforo completo di scarico automatico

Mitigeur lavabo complet avec bonde automatique

CODE / COEFFICIENT | CODICE / COEFFICIENTE |
CODE / COEFFICIENT

| | | | |
|----|-----------|-----------|------|
| CC | MR200CC_1 | MR200CC_2 | 13,5 |
| PL | MR200PL_1 | MR200PL_2 | 21,6 |
| SS | MR200SS_1 | MR200SS_2 | 16,9 |
| ON | MR200ON_1 | MR200ON_2 | 13,5 |
| BO | MR200BO_1 | MR200BO_2 | 16,2 |
| NP | MR200NP_1 | MR200NP_2 | 16,2 |
| CF | MR200CF_1 | MR200CF_2 | 20,3 |
| CS | MR200CS_1 | MR200CS_2 | 21,6 |
| II | MR200II_1 | MR200II_2 | 20,3 |
| IS | MR200IS_1 | MR200IS_2 | 21,6 |
| RS | MR200RS_1 | MR200RS_2 | 20,3 |
| SR | MR200SR_1 | MR200SR_2 | 21,6 |
| OO | MR200OO_1 | MR200OO_2 | 20,3 |
| OS | MR200OS_1 | MR200OS_2 | 21,6 |

PACKAGING
L: 353 mm
D: 225 mm
H: 226 mm

2,8 kg

MARBLE

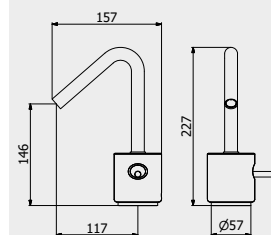
White
CarraraBlack
Marquina

PORTATE | WATER FLOW | DÉBIT D'EAU

| | | |
|---------|-------|-------|
| 1 BAR | 2 BAR | 3 BAR |
| 4,2 l/m | 5 l/m | 5 l/m |

ARTICLE | ARTICOLO | ARTICLE

MM200



Monohole washbasin mixer complete with drain

Miscelatore lavabo monoforo completo di scarico automatico

Mitigeur lavabo complet avec bonde automatique

CODE / COEFFICIENT | CODICE / COEFFICIENTE |
CODE / COEFFICIENT

| | | | |
|----|-----------|-----------|------|
| CC | MM200CC_1 | MM200CC_2 | 13,5 |
| PL | MM200PL_1 | MM200PL_2 | 21,6 |
| SS | MM200SS_1 | MM200SS_2 | 16,9 |
| ON | MM200ON_1 | MM200ON_2 | 13,5 |
| BO | MM200BO_1 | MM200BO_2 | 16,2 |
| NP | MM200NP_1 | MM200NP_2 | 16,2 |
| CF | MM200CF_1 | MM200CF_2 | 20,3 |
| CS | MM200CS_1 | MM200CS_2 | 21,6 |
| II | MM200II_1 | MM200II_2 | 20,3 |
| IS | MM200IS_1 | MM200IS_2 | 21,6 |
| RS | MM200RS_1 | MM200RS_2 | 20,3 |
| SR | MM200SR_1 | MM200SR_2 | 21,6 |
| OO | MM200OO_1 | MM200OO_2 | 20,3 |
| OS | MM200OS_1 | MM200OS_2 | 21,6 |

PACKAGING
L: 353 mm
D: 225 mm
H: 226 mm

2,8 kg

MARBLE

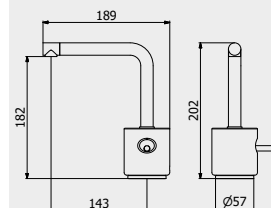
White
CarraraBlack
Marquina

PORTATE | WATER FLOW | DÉBIT D'EAU

| | | |
|---------|-------|-------|
| 1 BAR | 2 BAR | 3 BAR |
| 4,2 l/m | 5 l/m | 5 l/m |

ARTICLE | ARTICOLO | ARTICLE

MR202



Tall monohole washbasin mixer complete with drain

Miscelatore lavabo monoforo alto completo di scarico automatico

Mitigeur lavabo haut complet avec bonde automatique

CODE / COEFFICIENT | CODICE / COEFFICIENTE |
CODE / COEFFICIENT

| | | | |
|----|-----------|-----------|------|
| CC | MR202CC_1 | MR202CC_2 | 17,6 |
| PL | MR202PL_1 | MR202PL_2 | 28,2 |
| SS | MR202SS_1 | MR202SS_2 | 22,0 |
| ON | MR202ON_1 | MR202ON_2 | 17,6 |
| BO | MR202BO_1 | MR202BO_2 | 21,1 |
| NP | MR202NP_1 | MR202NP_2 | 21,1 |
| CF | MR202CF_1 | MR202CF_2 | 26,4 |
| CS | MR202CS_1 | MR202CS_2 | 28,2 |
| II | MR202II_1 | MR202II_2 | 26,4 |
| IS | MR202IS_1 | MR202IS_2 | 28,2 |
| RS | MR202RS_1 | MR202RS_2 | 26,4 |
| SR | MR202SR_1 | MR202SR_2 | 28,2 |
| OO | MR202OO_1 | MR202OO_2 | 26,4 |
| OS | MR202OS_1 | MR202OS_2 | 28,2 |

PACKAGING
L: 400 mm
D: 300 mm
H: 160 mm

3,5 kg

MARBLE

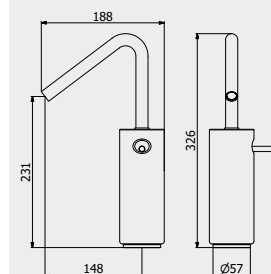
White
CarraraBlack
Marquina

PORTATE | WATER FLOW | DÉBIT D'EAU

| | | |
|---------|-------|-------|
| 1 BAR | 2 BAR | 3 BAR |
| 4,2 l/m | 5 l/m | 5 l/m |



ARTICLE | ARTICOLO | ARTICLE

MM202



Tall monohole washbasin mixer complete with drain
 Miscelatore lavabo monoforo alto completo di scarico automatico
 Mitigeur lavabo haut complet avec bonde automatique

CODE / COEFFICIENT | CODICE / COEFFICIENTE |
 CODE / COEFFICIENT

| | | | |
|----|-----------|-----------|------|
| CC | MM202CC_1 | MM202CC_2 | 17,6 |
| PL | MM202PL_1 | MM202PL_2 | 28,2 |
| SS | MM202SS_1 | MM202SS_2 | 22,0 |
| ON | MM202ON_1 | MM202ON_2 | 17,6 |
| BO | MM202BO_1 | MM202BO_2 | 21,1 |
| NP | MM202NP_1 | MM202NP_2 | 21,1 |
| CF | MM202CF_1 | MM202CF_2 | 26,4 |
| CS | MM202CS_1 | MM202CS_2 | 28,2 |
| II | MM202II_1 | MM202II_2 | 26,4 |
| IS | MM202IS_1 | MM202IS_2 | 28,2 |
| RS | MM202RS_1 | MM202RS_2 | 26,4 |
| SR | MM202SR_1 | MM202SR_2 | 28,2 |
| OO | MM202OO_1 | MM202OO_2 | 26,4 |
| OS | MM202OS_1 | MM202OS_2 | 28,2 |

PACKAGING

L: 400 mm
 D: 300 mm
 H: 160 mm

3,5 kg

MARBLE

White Carrara

Black Marquina

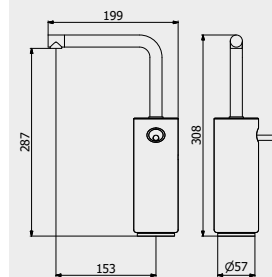

PORTATE | WATER FLOW | DÉBIT D'EAU

| | | |
|---------|-------|-------|
| 1 BAR | 2 BAR | 3 BAR |
| 4,2 l/m | 5 l/m | 5 l/m |

Marmo

ARTICLE | ARTICOLO | ARTICLE

MR306



Wall mounted widespread lavatory faucet
 Rubinetto lavabo da incasso
 Robinet de lavabo mural

CODE / COEFFICIENT | CODICE / COEFFICIENTE |
 CODE / COEFFICIENT

| | | | |
|----|-----------|-----------|------|
| CC | MR306CC_1 | MR306CC_2 | 23,1 |
| PL | MR306PL_1 | MR306PL_2 | 37,0 |
| SS | MR306SS_1 | MR306SS_2 | 28,9 |
| ON | MR306ON_1 | MR306ON_2 | 23,1 |
| BO | MR306BO_1 | MR306BO_2 | 27,7 |
| NP | MR306NP_1 | MR306NP_2 | 27,7 |
| CF | MR306CF_1 | MR306CF_2 | 34,7 |
| CS | MR306CS_1 | MR306CS_2 | 37,0 |
| II | MR306II_1 | MR306II_2 | 34,7 |
| IS | MR306IS_1 | MR306IS_2 | 37,0 |
| RS | MR306RS_1 | MR306RS_2 | 34,7 |
| SR | MR306SR_1 | MR306SR_2 | 37,0 |
| OO | MR306OO_1 | MR306OO_2 | 34,7 |
| OS | MR306OS_1 | MR306OS_2 | 37,0 |

PACKAGING

L: 470 mm
 D: 290 mm
 H: 160 mm

5 kg

MARBLE

White Carrara

Black Marquina

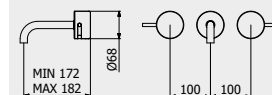

PORTATE | WATER FLOW | DÉBIT D'EAU

| | | |
|---------|-------|-------|
| 1 BAR | 2 BAR | 3 BAR |
| 4,2 l/m | 5 l/m | 5 l/m |

ARTICLE | ARTICOLO | ARTICLE

MR307



Wall mounted widespread lavatory faucet with long spout
 Rubinetto lavabo da incasso con bocca lunga
 Robinet de lavabo mural avec long bec

CODE / COEFFICIENT | CODICE / COEFFICIENTE |
 CODE / COEFFICIENT

| | | | |
|----|-----------|-----------|------|
| CC | MR307CC_1 | MR307CC_2 | 23,2 |
| PL | MR307PL_1 | MR307PL_2 | 37,1 |
| SS | MR307SS_1 | MR307SS_2 | 29,0 |
| ON | MR307ON_1 | MR307ON_2 | 23,2 |
| BO | MR307BO_1 | MR307BO_2 | 27,8 |
| NP | MR307NP_1 | MR307NP_2 | 27,8 |
| CF | MR307CF_1 | MR307CF_2 | 34,8 |
| CS | MR307CS_1 | MR307CS_2 | 37,1 |
| II | MR307II_1 | MR307II_2 | 34,8 |
| IS | MR307IS_1 | MR307IS_2 | 37,1 |
| RS | MR307RS_1 | MR307RS_2 | 34,8 |
| SR | MR307SR_1 | MR307SR_2 | 37,1 |
| OO | MR307OO_1 | MR307OO_2 | 34,8 |
| OS | MR307OS_1 | MR307OS_2 | 37,1 |

PACKAGING

L: 470 mm
 D: 290 mm
 H: 160 mm

5,1 kg

MARBLE

White Carrara

Black Marquina

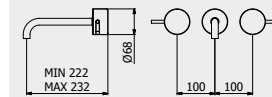

PORTATE | WATER FLOW | DÉBIT D'EAU

| | | |
|---------|-------|-------|
| 1 BAR | 2 BAR | 3 BAR |
| 4,2 l/m | 5 l/m | 5 l/m |

ARTICLE | ARTICOLO | ARTICLE

MR308



Wall mounted widespread lavatory faucet with short spout
 Rubinetto lavabo da incasso con bocca corta
 Robinet de lavabo mural avec court bec

CODE / COEFFICIENT | CODICE / COEFFICIENTE |
 CODE / COEFFICIENT

| | | | |
|----|-----------|-----------|------|
| CC | MR308CC_1 | MR308CC_2 | 23,2 |
| PL | MR308PL_1 | MR308PL_2 | 37,1 |
| SS | MR308SS_1 | MR308SS_2 | 29,0 |
| ON | MR308ON_1 | MR308ON_2 | 23,2 |
| BO | MR308BO_1 | MR308BO_2 | 27,8 |
| NP | MR308NP_1 | MR308NP_2 | 27,8 |
| CF | MR308CF_1 | MR308CF_2 | 34,8 |
| CS | MR308CS_1 | MR308CS_2 | 37,1 |
| II | MR308II_1 | MR308II_2 | 34,8 |
| IS | MR308IS_1 | MR308IS_2 | 37,1 |
| RS | MR308RS_1 | MR308RS_2 | 34,8 |
| SR | MR308SR_1 | MR308SR_2 | 37,1 |
| OO | MR308OO_1 | MR308OO_2 | 34,8 |
| OS | MR308OS_1 | MR308OS_2 | 37,1 |

PACKAGING
 L: 470 mm
 D: 290 mm
 H: 160 mm

4,9 kg

MARBLE

White
 Carrara

Black
 Marquina

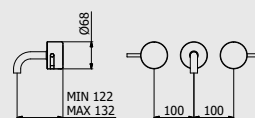

PORTATE | WATER FLOW | DÉBIT D'EAU

| | | |
|---------|-------|-------|
| 1 BAR | 2 BAR | 3 BAR |
| 4,2 l/m | 5 l/m | 5 l/m |

ARTICLE | ARTICOLO | ARTICLE

MR209



Mono hole wall mounted washbasin mixer
 Miscelatore lavabo a parete monoforo
 Mitigeur lavabo mural monotrou

CODE / COEFFICIENT | CODICE / COEFFICIENTE |
 CODE / COEFFICIENT

| | | | |
|----|-----------|-----------|------|
| CC | MR209CC_1 | MR209CC_2 | 17,9 |
| PL | MR209PL_1 | MR209PL_2 | 28,6 |
| SS | MR209SS_1 | MR209SS_2 | 22,4 |
| ON | MR209ON_1 | MR209ON_2 | 17,9 |
| BO | MR209BO_1 | MR209BO_2 | 21,5 |
| NP | MR209NP_1 | MR209NP_2 | 21,5 |
| CF | MR209CF_1 | MR209CF_2 | 26,9 |
| CS | MR209CS_1 | MR209CS_2 | 28,6 |
| II | MR209II_1 | MR209II_2 | 26,9 |
| IS | MR209IS_1 | MR209IS_2 | 28,6 |
| RS | MR209RS_1 | MR209RS_2 | 26,9 |
| SR | MR209SR_1 | MR209SR_2 | 28,6 |
| OO | MR209OO_1 | MR209OO_2 | 26,9 |
| OS | MR209OS_1 | MR209OS_2 | 28,6 |

PACKAGING
 L: 360 mm
 D: 220 mm
 H: 150 mm

3,8 kg

MARBLE

White
 Carrara

Black
 Marquina

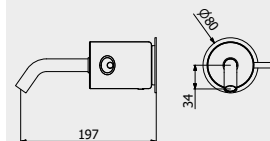

PORTATE | WATER FLOW | DÉBIT D'EAU

| | | |
|---------|-------|-------|
| 1 BAR | 2 BAR | 3 BAR |
| 4,2 l/m | 5 l/m | 5 l/m |

ARTICLE | ARTICOLO | ARTICLE

MM209



Mono hole wall mounted washbasin mixer
 Miscelatore lavabo a parete monoforo
 Mitigeur lavabo mural monotrou

CODE / COEFFICIENT | CODICE / COEFFICIENTE |
 CODE / COEFFICIENT

| | | | |
|----|-----------|-----------|------|
| CC | MM209CC_1 | MM209CC_2 | 17,9 |
| PL | MM209PL_1 | MM209PL_2 | 28,6 |
| SS | MM209SS_1 | MM209SS_2 | 22,4 |
| ON | MM209ON_1 | MM209ON_2 | 17,9 |
| BO | MM209BO_1 | MM209BO_2 | 21,5 |
| NP | MM209NP_1 | MM209NP_2 | 21,5 |
| CF | MM209CF_1 | MM209CF_2 | 26,9 |
| CS | MM209CS_1 | MM209CS_2 | 28,6 |
| II | MM209II_1 | MM209II_2 | 26,9 |
| IS | MM209IS_1 | MM209IS_2 | 28,6 |
| RS | MM209RS_1 | MM209RS_2 | 26,9 |
| SR | MM209SR_1 | MM209SR_2 | 28,6 |
| OO | MM209OO_1 | MM209OO_2 | 26,9 |
| OS | MM209OS_1 | MM209OS_2 | 28,6 |

PACKAGING
 L: 360 mm
 D: 220 mm
 H: 150 mm

3,8 kg

MARBLE

White
 Carrara

Black
 Marquina

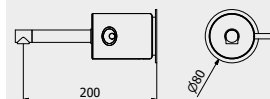

PORTATE | WATER FLOW | DÉBIT D'EAU

| | | |
|---------|-------|-------|
| 1 BAR | 2 BAR | 3 BAR |
| 4,2 l/m | 5 l/m | 5 l/m |



ARTICLE | ARTICOLO | ARTICLE

MR390



Three holes washbasin with tall spout

Lavabo tre fori a bocca alta

Lavabo trois trous bec haut

CODE / COEFFICIENT | CODICE / COEFFICIENTE |
CODE / COEFFICIENT

| | | | |
|----|-----------|-----------|------|
| CC | MR390CC_1 | MR390CC_2 | 23,7 |
| PL | MR390PL_1 | MR390PL_2 | 37,9 |
| SS | MR390SS_1 | MR390SS_2 | 29,6 |
| ON | MR390ON_1 | MR390ON_2 | 23,7 |
| BO | MR390BO_1 | MR390BO_2 | 28,4 |
| NP | MR390NP_1 | MR390NP_2 | 28,4 |
| CF | MR390CF_1 | MR390CF_2 | 35,6 |
| CS | MR390CS_1 | MR390CS_2 | 37,9 |
| II | MR390II_1 | MR390II_2 | 35,6 |
| IS | MR390IS_1 | MR390IS_2 | 37,9 |
| RS | MR390RS_1 | MR390RS_2 | 35,6 |
| SR | MR390SR_1 | MR390SR_2 | 37,9 |
| OO | MR390OO_1 | MR390OO_2 | 35,6 |
| OS | MR390OS_1 | MR390OS_2 | 37,9 |

PACKAGING

L: 470 mm
D: 290 mm
H: 160 mm

4,6 kg

MARBLE

White Carrara

Black Marquina

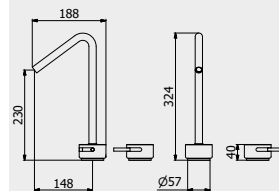

PORTATE | WATER FLOW | DÉBIT D'EAU

| | | |
|---------|-------|-------|
| 1 BAR | 2 BAR | 3 BAR |
| 4,2 l/m | 5 l/m | 5 l/m |

Marmo

ARTICLE | ARTICOLO | ARTICLE

MM390



Three holes washbasin with tall spout

Lavabo tre fori a bocca alta

Lavabo trois trous bec haut

CODE / COEFFICIENT | CODICE / COEFFICIENTE |
CODE / COEFFICIENT

| | | | |
|----|-----------|-----------|------|
| CC | MM390CC_1 | MM390CC_2 | 23,7 |
| PL | MM390PL_1 | MM390PL_2 | 37,9 |
| SS | MM390SS_1 | MM390SS_2 | 29,6 |
| ON | MM390ON_1 | MM390ON_2 | 23,7 |
| BO | MM390BO_1 | MM390BO_2 | 28,4 |
| NP | MM390NP_1 | MM390NP_2 | 28,4 |
| CF | MM390CF_1 | MM390CF_2 | 35,6 |
| CS | MM390CS_1 | MM390CS_2 | 37,9 |
| II | MM390II_1 | MM390II_2 | 35,6 |
| IS | MM390IS_1 | MM390IS_2 | 37,9 |
| RS | MM390RS_1 | MM390RS_2 | 35,6 |
| SR | MM390SR_1 | MM390SR_2 | 37,9 |
| OO | MM390OO_1 | MM390OO_2 | 35,6 |
| OS | MM390OS_1 | MM390OS_2 | 37,9 |

PACKAGING

L: 470 mm
D: 290 mm
H: 160 mm

4,6 kg

MARBLE

White Carrara

Black Marquina

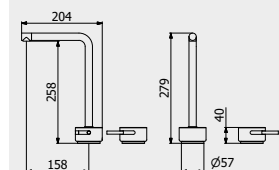

PORTATE | WATER FLOW | DÉBIT D'EAU

| | | |
|---------|-------|-------|
| 1 BAR | 2 BAR | 3 BAR |
| 4,2 l/m | 5 l/m | 5 l/m |

ARTICLE | ARTICOLO | ARTICLE

MR392



Three holes washbasin with short spout

Lavabo tre fori a bocca bassa

Lavabo trois trous bec bas

CODE / COEFFICIENT | CODICE / COEFFICIENTE |
CODE / COEFFICIENT

| | | | |
|----|-----------|-----------|------|
| CC | MR392CC_1 | MR392CC_2 | 22,8 |
| PL | MR392PL_1 | MR392PL_2 | 36,5 |
| SS | MR392SS_1 | MR392SS_2 | 28,5 |
| ON | MR392ON_1 | MR392ON_2 | 22,8 |
| BO | MR392BO_1 | MR392BO_2 | 27,4 |
| NP | MR392NP_1 | MR392NP_2 | 27,4 |
| CF | MR392CF_1 | MR392CF_2 | 34,2 |
| CS | MR392CS_1 | MR392CS_2 | 36,5 |
| II | MR392II_1 | MR392II_2 | 34,2 |
| IS | MR392IS_1 | MR392IS_2 | 36,5 |
| RS | MR392RS_1 | MR392RS_2 | 34,2 |
| SR | MR392SR_1 | MR392SR_2 | 36,5 |
| OO | MR392OO_1 | MR392OO_2 | 34,2 |
| OS | MR392OS_1 | MR392OS_2 | 36,5 |

PACKAGING

L: 470 mm
D: 290 mm
H: 160 mm

4,5 kg

MARBLE

White Carrara

Black Marquina

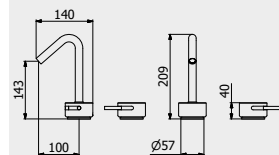

PORTATE | WATER FLOW | DÉBIT D'EAU

| | | |
|---------|-------|-------|
| 1 BAR | 2 BAR | 3 BAR |
| 4,2 l/m | 5 l/m | 5 l/m |

ARTICLE | ARTICOLO | ARTICLE

MM392



Three holes washbasin with short spout

Lavabo tre fori a bocca bassa

Lavabo trois trous bec bas

CODE / COEFFICIENT | CODICE / COEFFICIENTE |
CODE / COEFFICIENT

| | | | | |
|--|----|-----------|-----------|------|
| | CC | MM392CC_1 | MM392CC_2 | 22,8 |
| | PL | MM392PL_1 | MM392PL_2 | 36,5 |
| | SS | MM392SS_1 | MM392SS_2 | 28,5 |
| | ON | MM392ON_1 | MM392ON_2 | 22,8 |
| | BO | MM392BO_1 | MM392BO_2 | 27,4 |
| | NP | MM392NP_1 | MM392NP_2 | 27,4 |
| | CF | MM392CF_1 | MM392CF_2 | 34,2 |
| | CS | MM392CS_1 | MM392CS_2 | 36,5 |
| | II | MM392II_1 | MM392II_2 | 34,2 |
| | IS | MM392IS_1 | MM392IS_2 | 36,5 |
| | RS | MM392RS_1 | MM392RS_2 | 34,2 |
| | SR | MM392SR_1 | MM392SR_2 | 36,5 |
| | OO | MM392OO_1 | MM392OO_2 | 34,2 |
| | OS | MM392OS_1 | MM392OS_2 | 36,5 |

PACKAGING

 L: 470 mm
D: 290 mm
H: 160 mm

4,5 kg

MARBLE

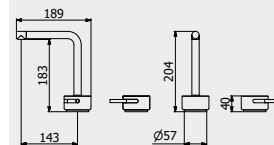
 White
Carrara Black
Marquina

PORTATE | WATER FLOW | DÉBIT D'EAU

| | | |
|---------|-------|-------|
| 1 BAR | 2 BAR | 3 BAR |
| 4,2 l/m | 5 l/m | 5 l/m |

ARTICLE | ARTICOLO | ARTICLE

MR220



Monohole bidet mixer complete with drain

Miscelatore bidet monoforo completo di scarico automatico

Mitigeur bidet complet avec bonde automatique

CODE / COEFFICIENT | CODICE / COEFFICIENTE |
CODE / COEFFICIENT

| | | | | |
|--|----|-----------|-----------|------|
| | CC | MR220CC_1 | MR220CC_2 | 13,5 |
| | PL | MR220PL_1 | MR220PL_2 | 21,6 |
| | SS | MR220SS_1 | MR220SS_2 | 16,9 |
| | ON | MR220ON_1 | MR220ON_2 | 13,5 |
| | BO | MR220BO_1 | MR220BO_2 | 16,2 |
| | NP | MR220NP_1 | MR220NP_2 | 16,2 |
| | CF | MR220CF_1 | MR220CF_2 | 20,3 |
| | CS | MR220CS_1 | MR220CS_2 | 21,6 |
| | II | MR220II_1 | MR220II_2 | 20,3 |
| | IS | MR220IS_1 | MR220IS_2 | 21,6 |
| | RS | MR220RS_1 | MR220RS_2 | 20,3 |
| | SR | MR220SR_1 | MR220SR_2 | 21,6 |
| | OO | MR220OO_1 | MR220OO_2 | 20,3 |
| | OS | MR220OS_1 | MR220OS_2 | 21,6 |

PACKAGING

 L: 353 mm
D: 225 mm
H: 226 mm

2,6 kg

MARBLE

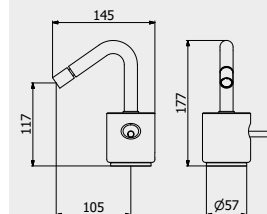
 White
Carrara Black
Marquina

PORTATE | WATER FLOW | DÉBIT D'EAU

| | | |
|---------|-------|-------|
| 1 BAR | 2 BAR | 3 BAR |
| 4,2 l/m | 5 l/m | 5 l/m |

ARTICLE | ARTICOLO | ARTICLE

MM220



Monohole bidet mixer complete with drain

Miscelatore bidet monoforo completo di scarico automatico

Mitigeur bidet complet avec bonde automatique

CODE / COEFFICIENT | CODICE / COEFFICIENTE |
CODE / COEFFICIENT

| | | | | |
|--|----|-----------|-----------|------|
| | CC | MM220CC_1 | MM220CC_2 | 13,5 |
| | PL | MM220PL_1 | MM220PL_2 | 21,6 |
| | SS | MM220SS_1 | MM220SS_2 | 16,9 |
| | ON | MM220ON_1 | MM220ON_2 | 13,5 |
| | BO | MM220BO_1 | MM220BO_2 | 16,2 |
| | NP | MM220NP_1 | MM220NP_2 | 16,2 |
| | CF | MM220CF_1 | MM220CF_2 | 20,3 |
| | CS | MM220CS_1 | MM220CS_2 | 21,6 |
| | II | MM220II_1 | MM220II_2 | 20,3 |
| | IS | MM220IS_1 | MM220IS_2 | 21,6 |
| | RS | MM220RS_1 | MM220RS_2 | 20,3 |
| | SR | MM220SR_1 | MM220SR_2 | 21,6 |
| | OO | MM220OO_1 | MM220OO_2 | 20,3 |
| | OS | MM220OS_1 | MM220OS_2 | 21,6 |

PACKAGING

 L: 353 mm
D: 225 mm
H: 226 mm

2,6 kg

MARBLE

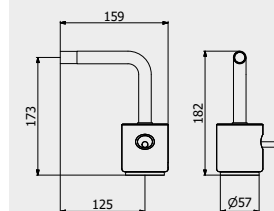
 White
Carrara Black
Marquina

PORTATE | WATER FLOW | DÉBIT D'EAU

| | | |
|---------|-------|-------|
| 1 BAR | 2 BAR | 3 BAR |
| 4,2 l/m | 5 l/m | 5 l/m |



ARTICLE | ARTICOLO | ARTICLE

MR393



Three holes bidet with adjustable spout
Bidet tre fori con bocca snodabile
Bidet trois trous

CODE / COEFFICIENT | CODICE / COEFFICIENTE |
CODE / COEFFICIENT

| | | | |
|----|-----------|-----------|------|
| CC | MR393CC_1 | MR393CC_2 | 22,2 |
| PL | MR393PL_1 | MR393PL_2 | 35,5 |
| SS | MR393SS_1 | MR393SS_2 | 27,8 |
| ON | MR393ON_1 | MR393ON_2 | 22,2 |
| BO | MR393BO_1 | MR393BO_2 | 26,6 |
| NP | MR393NP_1 | MR393NP_2 | 26,6 |
| CF | MR393CF_1 | MR393CF_2 | 33,3 |
| CS | MR393CS_1 | MR393CS_2 | 35,5 |
| II | MR393II_1 | MR393II_2 | 33,3 |
| IS | MR393IS_1 | MR393IS_2 | 35,5 |
| RS | MR393RS_1 | MR393RS_2 | 33,3 |
| SR | MR393SR_1 | MR393SR_2 | 35,5 |
| OO | MR393OO_1 | MR393OO_2 | 33,3 |
| OS | MR393OS_1 | MR393OS_2 | 35,5 |

PACKAGING

L: 470 mm
D: 290 mm
H: 160 mm

4,3 kg

MARBLE

White Carrara

Black Marquina

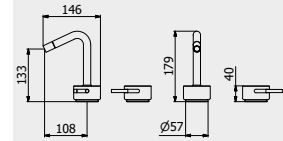

PORTATE | WATER FLOW | DÉBIT D'EAU

| | | |
|---------|-------|-------|
| 1 BAR | 2 BAR | 3 BAR |
| 4,2 l/m | 5 l/m | 5 l/m |

Marmo

ARTICLE | ARTICOLO | ARTICLE

MM393



Three holes bidet with adjustable spout
Bidet tre fori con bocca snodabile
Bidet trois trous

CODE / COEFFICIENT | CODICE / COEFFICIENTE |
CODE / COEFFICIENT

| | | | |
|----|-----------|-----------|------|
| CC | MM393CC_1 | MM393CC_2 | 22,2 |
| PL | MM393PL_1 | MM393PL_2 | 35,5 |
| SS | MM393SS_1 | MM393SS_2 | 27,8 |
| ON | MM393ON_1 | MM393ON_2 | 22,2 |
| BO | MM393BO_1 | MM393BO_2 | 26,6 |
| NP | MM393NP_1 | MM393NP_2 | 26,6 |
| CF | MM393CF_1 | MM393CF_2 | 33,3 |
| CS | MM393CS_1 | MM393CS_2 | 35,5 |
| II | MM393II_1 | MM393II_2 | 33,3 |
| IS | MM393IS_1 | MM393IS_2 | 35,5 |
| RS | MM393RS_1 | MM393RS_2 | 33,3 |
| SR | MM393SR_1 | MM393SR_2 | 35,5 |
| OO | MM393OO_1 | MM393OO_2 | 33,3 |
| OS | MM393OS_1 | MM393OS_2 | 35,5 |

PACKAGING

L: 470 mm
D: 290 mm
H: 160 mm

4,3 kg

MARBLE

White Carrara

Black Marquina

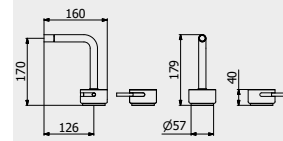

PORTATE | WATER FLOW | DÉBIT D'EAU

| | | |
|---------|-------|-------|
| 1 BAR | 2 BAR | 3 BAR |
| 4,2 l/m | 5 l/m | 5 l/m |

ARTICLE | ARTICOLO | ARTICLE

MR300



Exposed parts for manual wall mixer

Set di parti esterne per miscelatore a parete ad una via
Partie extérieure pour mitigeur encastré à une voie

CODE / COEFFICIENT | CODICE / COEFFICIENTE |
CODE / COEFFICIENT

| | | | |
|----|-------------|-------------|-----|
| CC | EMR300CC_19 | EMR300CC_20 | 5,5 |
| PL | EMR300PL_19 | EMR300PL_20 | 8,8 |
| SS | EMR300SS_19 | EMR300SS_20 | 6,9 |
| ON | EMR300ON_19 | EMR300ON_20 | 5,5 |
| BO | EMR300BO_19 | EMR300BO_20 | 6,6 |
| NP | EMR300NP_19 | EMR300NP_20 | 6,6 |
| CF | EMR300CF_19 | EMR300CF_20 | 8,3 |
| CS | EMR300CS_19 | EMR300CS_20 | 8,8 |
| II | EMR300II_19 | EMR300II_20 | 8,3 |
| IS | EMR300IS_19 | EMR300IS_20 | 8,8 |
| RS | EMR300RS_19 | EMR300RS_20 | 8,3 |
| SR | EMR300SR_19 | EMR300SR_20 | 8,8 |
| OO | EMR300OO_19 | EMR300OO_20 | 8,3 |
| OS | EMR300OS_19 | EMR300OS_20 | 8,8 |

PACKAGING

L: 240 mm
D: 215 mm
H: 110 mm

1,6 kg

MARBLE

White Carrara

Black Marquina

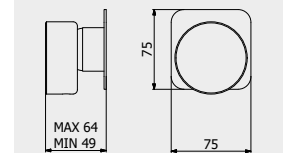

PORTATE | WATER FLOW | DÉBIT D'EAU

| | | |
|----------|----------|--------|
| 1 BAR | 2 BAR | 3 BAR |
| 11,5 l/m | 16,3 l/m | 20 l/m |

Built-in body to be purchased separately

Corpo incasso da acquistare separatamente

Corps intégré à acheter séparément



CODICE | CODE | CODE

INC300XXXN_19

COEFFICIENT | COEFFICIENTE | COEFFICIENT

1,8

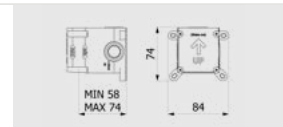

ARTICLE | ARTICOLO | ARTICLE

MR310



Exposed parts for manual wall mixer with two ways diverter
 Miscelatore doccia a parete con deviatore due vie
 Mitigeur douche mural deux voies avec inverseur

CODE / COEFFICIENT | CODICE / COEFFICIENTE |
 CODE / COEFFICIENT

| | | | |
|----|-------------|-------------|------|
| CC | EMR310CC_19 | EMR310CC_20 | 7,9 |
| PL | EMR310PL_19 | EMR310PL_20 | 12,6 |
| SS | EMR310SS_19 | EMR310SS_20 | 9,9 |
| ON | EMR310ON_19 | EMR310ON_20 | 7,9 |
| BO | EMR310BO_19 | EMR310BO_20 | 9,5 |
| NP | EMR310NP_19 | EMR310NP_20 | 9,5 |
| CF | EMR310CF_19 | EMR310CF_20 | 11,9 |
| CS | EMR310CS_19 | EMR310CS_20 | 12,6 |
| II | EMR310II_19 | EMR310II_20 | 11,9 |
| IS | EMR310IS_19 | EMR310IS_20 | 12,6 |
| RS | EMR310RS_19 | EMR310RS_20 | 11,9 |
| SR | EMR310SR_19 | EMR310SR_20 | 12,6 |
| OO | EMR310OO_19 | EMR310OO_20 | 11,9 |
| OS | EMR310OS_19 | EMR310OS_20 | 12,6 |

PACKAGING

L: 240 mm
 D: 215 mm
 H: 110 mm

2,4 kg

MARBLE

White
 Carrara

Black
 Marquina

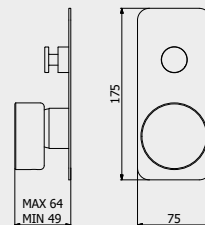

PORTATE | WATER FLOW | DÉBIT D'EAU

| | | |
|---------|----------|--------|
| 1 BAR | 2 BAR | 3 BAR |
| 9,2 l/m | 12,8 l/m | 16 l/m |

Built-in body to be purchased separately

Corpo incasso da acquistare separatamente

Corps intégré à acheter séparément



CODICE | CODE | CODE

INC310XXXN_19

COEFFICIENT | COEFFICIENTE | COEFFICIENT

3,3

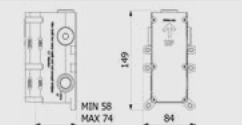

ARTICLE | ARTICOLO | ARTICLE

MR312



Exposed parts for manual wall mixer with three ways diverter
 Set di parti esterne per miscelatore a parete a tre vie
 Mitigeur douche mural trois voies avec inverseur

CODE / COEFFICIENT | CODICE / COEFFICIENTE |
 CODE / COEFFICIENT

| | | | |
|----|-------------|-------------|------|
| CC | EMR312CC_19 | EMR312CC_20 | 9,2 |
| PL | EMR312PL_19 | EMR312PL_20 | 14,7 |
| SS | EMR312SS_19 | EMR312SS_20 | 11,5 |
| ON | EMR312ON_19 | EMR312ON_20 | 9,2 |
| BO | EMR312BO_19 | EMR312BO_20 | 11,0 |
| NP | EMR312NP_19 | EMR312NP_20 | 11,0 |
| CF | EMR312CF_19 | EMR312CF_20 | 13,8 |
| CS | EMR312CS_19 | EMR312CS_20 | 14,7 |
| II | EMR312II_19 | EMR312II_20 | 13,8 |
| IS | EMR312IS_19 | EMR312IS_20 | 14,7 |
| RS | EMR312RS_19 | EMR312RS_20 | 13,8 |
| SR | EMR312SR_19 | EMR312SR_20 | 14,7 |
| OO | EMR312OO_19 | EMR312OO_20 | 13,8 |
| OS | EMR312OS_19 | EMR312OS_20 | 14,7 |

PACKAGING

L: 240 mm
 D: 215 mm
 H: 110 mm

2,4 kg

MARBLE

White
 Carrara

Black
 Marquina

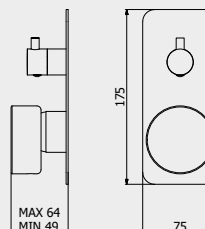

PORTATE | WATER FLOW | DÉBIT D'EAU

| | | |
|---------|----------|----------|
| 1 BAR | 2 BAR | 3 BAR |
| 9,5 l/m | 13,4 l/m | 16,9 l/m |

Built-in body to be purchased separately

Corpo incasso da acquistare separatamente

Corps intégré à acheter séparément



CODICE | CODE | CODE

INC312XXXN_19

COEFFICIENT | COEFFICIENTE | COEFFICIENT

3,3

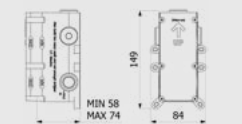

ARTICLE | ARTICOLO | ARTICLE

MR400



Two holes wall mounted shower

Comandi doccia a parete due fori
 Mélangeur deux trous douche

CODE / COEFFICIENT | CODICE / COEFFICIENTE |
 CODE / COEFFICIENT

| | | | |
|----|-----------|-----------|------|
| CC | MR400CC_1 | MR400CC_2 | 13,5 |
| PL | MR400PL_1 | MR400PL_2 | 21,6 |
| SS | MR400SS_1 | MR400SS_2 | 16,9 |
| ON | MR400ON_1 | MR400ON_2 | 13,5 |
| BO | MR400BO_1 | MR400BO_2 | 16,2 |
| NP | MR400NP_1 | MR400NP_2 | 16,2 |
| CF | MR400CF_1 | MR400CF_2 | 20,3 |
| CS | MR400CS_1 | MR400CS_2 | 21,6 |
| II | MR400II_1 | MR400II_2 | 20,3 |
| IS | MR400IS_1 | MR400IS_2 | 21,6 |
| RS | MR400RS_1 | MR400RS_2 | 20,3 |
| SR | MR400SR_1 | MR400SR_2 | 21,6 |
| OO | MR400OO_1 | MR400OO_2 | 20,3 |
| OS | MR400OS_1 | MR400OS_2 | 21,6 |

PACKAGING

L: 240 mm
 D: 215 mm
 H: 110 mm

2,8 kg

MARBLE

White
 Carrara

Black
 Marquina

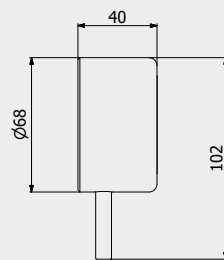

PORTATE | WATER FLOW | DÉBIT D'EAU

| | | |
|--------|--------|----------|
| 1 BAR | 2 BAR | 3 BAR |
| 28 l/m | 40 l/m | 49,3 l/m |



ARTICLE | ARTICOLO | ARTICLE

MR313



Exposed parts for manual wall mixer with 2 ways with shower kit
Set di parti esterne per miscelatore a parete a due vie completo di kit doccia
Partie extérieure pour mitigeur encastré à deux voies avec douchette

CODE / COEFFICIENT | CODICE / COEFFICIENTE |
CODE / COEFFICIENT

| | | | |
|----|-------------|-------------|------|
| CC | EMR313CC_19 | EMR313CC_20 | 12,8 |
| PL | EMR313PL_19 | EMR313PL_20 | 20,5 |
| SS | EMR313SS_19 | EMR313SS_20 | 16,0 |
| ON | EMR313ON_19 | EMR313ON_20 | 12,8 |
| BO | EMR313BO_19 | EMR313BO_20 | 15,4 |
| NP | EMR313NP_19 | EMR313NP_20 | 15,4 |
| CF | EMR313CF_19 | EMR313CF_20 | 19,2 |
| CS | EMR313CS_19 | EMR313CS_20 | 20,5 |
| II | EMR313II_19 | EMR313II_20 | 19,2 |
| IS | EMR313IS_19 | EMR313IS_20 | 20,5 |
| RS | EMR313RS_19 | EMR313RS_20 | 19,2 |
| SR | EMR313SR_19 | EMR313SR_20 | 20,5 |
| OO | EMR313OO_19 | EMR313OO_20 | 19,2 |
| OS | EMR313OS_19 | EMR313OS_20 | 20,5 |

PACKAGING
L: 353 mm
D: 225 mm
H: 226 mm

3,2 kg

MARBLE

White Carrara

Black Marquina

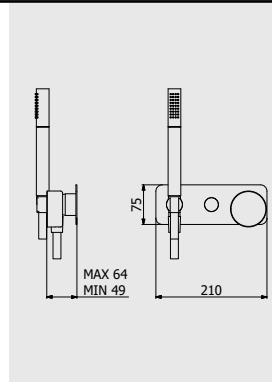

Marmo

PORTATE | WATER FLOW | DÉBIT D'EAU

| | | |
|--------|----------|----------|
| 1 BAR | 2 BAR | 3 BAR |
| 10 l/m | 14,1 l/m | 17,2 l/m |

Built-in body to be purchased separately

Corpo incasso da acquistare separatamente

Corps intégré à acheter séparément



CODICE | CODE | CODE

INC131XXXN_19

COEFFICIENT | COEFFICIENTE | COEFFICIENT

3,6

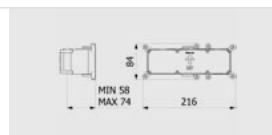

ARTICLE | ARTICOLO | ARTICLE

MR314



Exposed parts for manual wall mixer with 3 ways with shower kit
Set di parti esterne per miscelatore a parete a tre vie completo di kit doccia
Partie extérieure pour mitigeur encastré à trois voies avec douchette

CODE / COEFFICIENT | CODICE / COEFFICIENTE |
CODE / COEFFICIENT

| | | | |
|----|-------------|-------------|------|
| CC | EMR314CC_19 | EMR314CC_20 | 15,8 |
| PL | EMR314PL_19 | EMR314PL_20 | 25,3 |
| SS | EMR314SS_19 | EMR314SS_20 | 19,8 |
| ON | EMR314ON_19 | EMR314ON_20 | 15,8 |
| BO | EMR314BO_19 | EMR314BO_20 | 19,0 |
| NP | EMR314NP_19 | EMR314NP_20 | 19,0 |
| CF | EMR314CF_19 | EMR314CF_20 | 23,7 |
| CS | EMR314CS_19 | EMR314CS_20 | 25,3 |
| II | EMR314II_19 | EMR314II_20 | 23,7 |
| IS | EMR314IS_19 | EMR314IS_20 | 25,3 |
| RS | EMR314RS_19 | EMR314RS_20 | 23,7 |
| SR | EMR314SR_19 | EMR314SR_20 | 25,3 |
| OO | EMR314OO_19 | EMR314OO_20 | 23,7 |
| OS | EMR314OS_19 | EMR314OS_20 | 25,3 |

PACKAGING
L: 353 mm
D: 225 mm
H: 226 mm

3,4 kg

MARBLE

White Carrara

Black Marquina

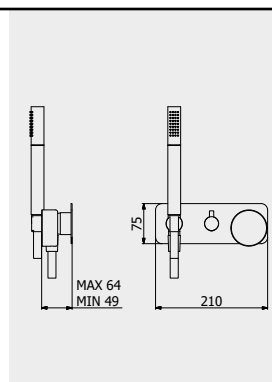

PORTATE | WATER FLOW | DÉBIT D'EAU

| | | |
|---------|----------|----------|
| 1 BAR | 2 BAR | 3 BAR |
| 8,3 l/m | 11,7 l/m | 14,3 l/m |

Built-in body to be purchased separately

Corpo incasso da acquistare separatamente

Corps intégré à acheter séparément



CODICE | CODE | CODE

INC141XXXN_19

COEFFICIENT | COEFFICIENTE | COEFFICIENT

3,7

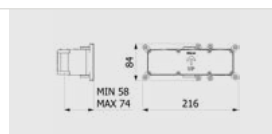

ARTICLE | ARTICOLO | ARTICLE

MR410



Three holes wall mounted shower with two ways diverter
Tre rubinetti a parete per doccia con deviatore a due vie
Melangeur trois trous douche avec inverseur deux voies

CODE / COEFFICIENT | CODICE / COEFFICIENTE |
CODE / COEFFICIENT

| | | | |
|----|-----------|-----------|------|
| CC | MR410CC_1 | MR410CC_2 | 21,6 |
| PL | MR410PL_1 | MR410PL_2 | 34,6 |
| SS | MR410SS_1 | MR410SS_2 | 27,0 |
| ON | MR410ON_1 | MR410ON_2 | 21,6 |
| BO | MR410BO_1 | MR410BO_2 | 25,9 |
| NP | MR410NP_1 | MR410NP_2 | 25,9 |
| CF | MR410CF_1 | MR410CF_2 | 32,4 |
| CS | MR410CS_1 | MR410CS_2 | 34,6 |
| II | MR410II_1 | MR410II_2 | 32,4 |
| IS | MR410IS_1 | MR410IS_2 | 34,6 |
| RS | MR410RS_1 | MR410RS_2 | 32,4 |
| SR | MR410SR_1 | MR410SR_2 | 34,6 |
| OO | MR410OO_1 | MR410OO_2 | 32,4 |
| OS | MR410OS_1 | MR410OS_2 | 34,6 |

PACKAGING
L: 240 mm
D: 215 mm
H: 110 mm

3,3 kg

MARBLE

White Carrara

Black Marquina

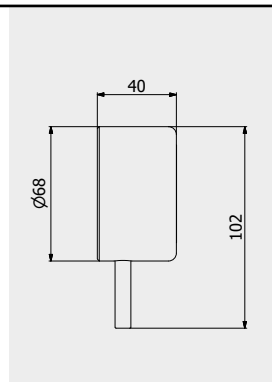

PORTATE | WATER FLOW | DÉBIT D'EAU

| | | |
|--------|----------|----------|
| 1 BAR | 2 BAR | 3 BAR |
| 16 l/m | 22,4 l/m | 27,4 l/m |

ARTICLE | ARTICOLO | ARTICLE

MR396



Five holes bath filler with diverter and shower head

Bordo vasca cinque fori con deviatore e doccino integrato

Bain/douche cinq trous avec inverseur et Kit Douche

CODE / COEFFICIENT | CODICE / COEFFICIENTE |
CODE / COEFFICIENT

| | | | |
|----|-----------|-----------|------|
| CC | MR396CC_1 | MR396CC_2 | 41,8 |
| PL | MR396PL_1 | MR396PL_2 | 66,9 |
| SS | MR396SS_1 | MR396SS_2 | 52,3 |
| ON | MR396ON_1 | MR396ON_2 | 41,8 |
| BO | MR396BO_1 | MR396BO_2 | 50,2 |
| NP | MR396NP_1 | MR396NP_2 | 50,2 |
| CF | MR396CF_1 | MR396CF_2 | 62,7 |
| CS | MR396CS_1 | MR396CS_2 | 66,9 |
| II | MR396II_1 | MR396II_2 | 62,7 |
| IS | MR396IS_1 | MR396IS_2 | 66,9 |
| RS | MR396RS_1 | MR396RS_2 | 62,7 |
| SR | MR396SR_1 | MR396SR_2 | 66,9 |
| OO | MR396OO_1 | MR396OO_2 | 62,7 |
| OS | MR396OS_1 | MR396OS_2 | 66,9 |

PACKAGING

L: 685 mm
D: 345 mm
H: 168 mm

7,2 kg

MARBLE

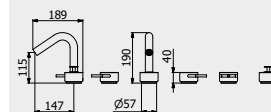
White
CarraraBlack
Marquina

PORTATE | WATER FLOW | DÉBIT D'EAU

| | | |
|--------|----------|----------|
| 1 BAR | 2 BAR | 3 BAR |
| 13 l/m | 18,8 l/m | 23,1 l/m |

ARTICLE | ARTICOLO | ARTICLE

MM396



Five holes bath filler with diverter and shower head

Bordo vasca cinque fori con deviatore e doccino integrato

Bain/douche cinq trous avec inverseur et Kit Douche

CODE / COEFFICIENT | CODICE / COEFFICIENTE |
CODE / COEFFICIENT

| | | | |
|----|-----------|-----------|------|
| CC | MM396CC_1 | MM396CC_2 | 41,8 |
| PL | MM396PL_1 | MM396PL_2 | 66,9 |
| SS | MM396SS_1 | MM396SS_2 | 52,3 |
| ON | MM396ON_1 | MM396ON_2 | 41,8 |
| BO | MM396BO_1 | MM396BO_2 | 50,2 |
| NP | MM396NP_1 | MM396NP_2 | 50,2 |
| CF | MM396CF_1 | MM396CF_2 | 62,7 |
| CS | MM396CS_1 | MM396CS_2 | 66,9 |
| II | MM396II_1 | MM396II_2 | 62,7 |
| IS | MM396IS_1 | MM396IS_2 | 66,9 |
| RS | MM396RS_1 | MM396RS_2 | 62,7 |
| SR | MM396SR_1 | MM396SR_2 | 66,9 |
| OO | MM396OO_1 | MM396OO_2 | 62,7 |
| OS | MM396OS_1 | MM396OS_2 | 66,9 |

PACKAGING

L: 685 mm
D: 345 mm
H: 168 mm

7,2 kg

MARBLE

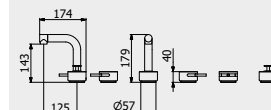
White
CarraraBlack
Marquina

PORTATE | WATER FLOW | DÉBIT D'EAU

| | | |
|--------|----------|----------|
| 1 BAR | 2 BAR | 3 BAR |
| 13 l/m | 18,8 l/m | 23,1 l/m |

ARTICLE | ARTICOLO | ARTICLE

MR397



Four holes bath filler with overflow outlet connection, diverter and showered

Bordo vasca quattro fori per colonna riempimento con deviatore e doccino

Bain/douche 4 trous avec inverseur et Kit Douche pour remplissage ETP

CODE / COEFFICIENT | CODICE / COEFFICIENTE |
CODE / COEFFICIENT

| | | | |
|----|-----------|-----------|------|
| CC | MR397CC_1 | MR397CC_2 | 30,8 |
| PL | MR397PL_1 | MR397PL_2 | 49,3 |
| SS | MR397SS_1 | MR397SS_2 | 38,5 |
| ON | MR397ON_1 | MR397ON_2 | 30,8 |
| BO | MR397BO_1 | MR397BO_2 | 37,0 |
| NP | MR397NP_1 | MR397NP_2 | 37,0 |
| CF | MR397CF_1 | MR397CF_2 | 46,2 |
| CS | MR397CS_1 | MR397CS_2 | 49,3 |
| II | MR397II_1 | MR397II_2 | 46,2 |
| IS | MR397IS_1 | MR397IS_2 | 49,3 |
| RS | MR397RS_1 | MR397RS_2 | 46,2 |
| SR | MR397SR_1 | MR397SR_2 | 49,3 |
| OO | MR397OO_1 | MR397OO_2 | 46,2 |
| OS | MR397OS_1 | MR397OS_2 | 49,3 |

PACKAGING

L: 685 mm
D: 345 mm
H: 168 mm

6,8 kg

MARBLE

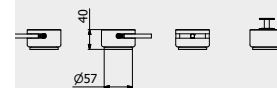
White
CarraraBlack
Marquina

PORTATE | WATER FLOW | DÉBIT D'EAU

| | | |
|--------|--------|--------|
| 1 BAR | 2 BAR | 3 BAR |
| 16 l/m | 23 l/m | 28 l/m |



ARTICLE | ARTICOLO | ARTICLE

MR398



Five holes wall mounted bath filler with diverter and shower head
Bordo vasca cinque fori a parete con deviatore e doccino integrato
Bain/douche cinq trous avec inverseur et Kit Douche

CODE / COEFFICIENT | CODICE / COEFFICIENTE | PACKAGING
CODE / COEFFICIENT

| | | | |
|----|-----------|-----------|------|
| CC | MR398CC_1 | MR398CC_2 | 36,1 |
| PL | MR398PL_1 | MR398PL_2 | 57,8 |
| SS | MR398SS_1 | MR398SS_2 | 45,1 |
| ON | MR398ON_1 | MR398ON_2 | 36,1 |
| BO | MR398BO_1 | MR398BO_2 | 43,3 |
| NP | MR398NP_1 | MR398NP_2 | 43,3 |
| CF | MR398CF_1 | MR398CF_2 | 54,2 |
| CS | MR398CS_1 | MR398CS_2 | 57,8 |
| II | MR398II_1 | MR398II_2 | 54,2 |
| IS | MR398IS_1 | MR398IS_2 | 57,8 |
| RS | MR398RS_1 | MR398RS_2 | 54,2 |
| SR | MR398SR_1 | MR398SR_2 | 57,8 |
| OO | MR398OO_1 | MR398OO_2 | 54,2 |
| OS | MR398OS_1 | MR398OS_2 | 57,8 |

L: 470 mm
D: 290 mm
H: 160 mm

5,8 kg

MARBLE

White Carrara

Black Marquina

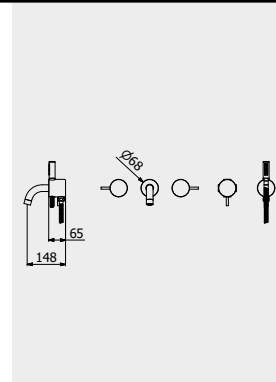

PORTATE | WATER FLOW | DÉBIT D'EAU

| | | |
|----------|----------|--------|
| 1 BAR | 2 BAR | 3 BAR |
| 12,1 l/m | 17,1 l/m | 21 l/m |

Marmo

ARTICLE | ARTICOLO | ARTICLE

MR399



Free-standing bath filler
Bordo vasca da terra con doccino integrato
Bain douche complet alimentation au sol

CODE / COEFFICIENT | CODICE / COEFFICIENTE | PACKAGING
CODE / COEFFICIENT

| | | | |
|----|-----------|-----------|-------|
| CC | MR399CC_1 | MR399CC_2 | 79,6 |
| PL | MR399PL_1 | MR399PL_2 | 127,4 |
| SS | MR399SS_1 | MR399SS_2 | 99,5 |
| ON | MR399ON_1 | MR399ON_2 | 79,6 |
| BO | MR399BO_1 | MR399BO_2 | 95,5 |
| NP | MR399NP_1 | MR399NP_2 | 95,5 |
| CF | MR399CF_1 | MR399CF_2 | 119,4 |
| CS | MR399CS_1 | MR399CS_2 | 127,4 |
| II | MR399II_1 | MR399II_2 | 119,4 |
| IS | MR399IS_1 | MR399IS_2 | 127,4 |
| RS | MR399RS_1 | MR399RS_2 | 119,4 |
| SR | MR399SR_1 | MR399SR_2 | 127,4 |
| OO | MR399OO_1 | MR399OO_2 | 119,4 |
| OS | MR399OS_1 | MR399OS_2 | 127,4 |

L: 900 mm
D: 470 mm
H: 470 mm

21 kg

MARBLE

White Carrara

Black Marquina

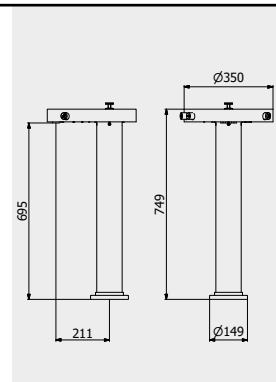

PORTATE | WATER FLOW | DÉBIT D'EAU

| | | |
|----------|----------|----------|
| 1 BAR | 2 BAR | 3 BAR |
| 13,9 l/m | 19,8 l/m | 24,5 l/m |

ARTICLE | ARTICOLO | ARTICLE

MR022



Duplex MARMO
Duplex MARMO
Duplex MARMO

CODE / COEFFICIENT | CODICE / COEFFICIENTE | PACKAGING
CODE / COEFFICIENT

| | | | |
|----|-----------|-----------|------|
| CC | MR022CC_1 | MR022CC_2 | 8,6 |
| PL | MR022PL_1 | MR022PL_2 | 13,8 |
| SS | MR022SS_1 | MR022SS_2 | 10,8 |
| ON | MR022ON_1 | MR022ON_2 | 8,6 |
| BO | MR022BO_1 | MR022BO_2 | 10,3 |
| NP | MR022NP_1 | MR022NP_2 | 10,3 |
| CF | MR022CF_1 | MR022CF_2 | 12,9 |
| CS | MR022CS_1 | MR022CS_2 | 13,8 |
| II | MR022II_1 | MR022II_2 | 12,9 |
| IS | MR022IS_1 | MR022IS_2 | 13,8 |
| RS | MR022RS_1 | MR022RS_2 | 12,9 |
| SR | MR022SR_1 | MR022SR_2 | 13,8 |
| OO | MR022OO_1 | MR022OO_2 | 12,9 |
| OS | MR022OS_1 | MR022OS_2 | 13,8 |

L: 360 mm
D: 220 mm
H: 150 mm

1,8 kg

MARBLE

White Carrara

Black Marquina

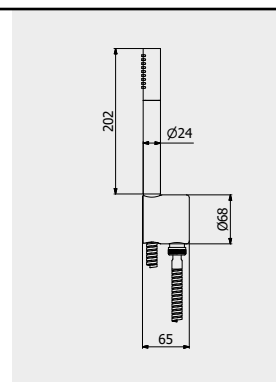

PORTATE | WATER FLOW | DÉBIT D'EAU

| | | |
|----------|----------|----------|
| 1 BAR | 2 BAR | 3 BAR |
| 13,9 l/m | 19,8 l/m | 24,5 l/m |



ARTICLE | ARTICOLO | ARTICLE

MR320



Wall mounted spout

Bocca d'erogazione a parete

Bec de remplissage mural

CODE / COEFFICIENT | CODICE / COEFFICIENTE |
CODE / COEFFICIENT

| | | | | |
|---|----|-----------|-----------|-----|
| ● | CC | MR320CC_1 | MR320CC_2 | 5,6 |
| ● | PL | MR320PL_1 | MR320PL_2 | 9,0 |
| ● | SS | MR320SS_1 | MR320SS_2 | 7,0 |
| ● | ON | MR320ON_1 | MR320ON_2 | 5,6 |
| ● | BO | MR320BO_1 | MR320BO_2 | 6,7 |
| ● | NP | MR320NP_1 | MR320NP_2 | 6,7 |
| ● | CF | MR320CF_1 | MR320CF_2 | 8,4 |
| ● | CS | MR320CS_1 | MR320CS_2 | 9,0 |
| ● | II | MR320II_1 | MR320II_2 | 8,4 |
| ● | IS | MR320IS_1 | MR320IS_2 | 9,0 |
| ● | RS | MR320RS_1 | MR320RS_2 | 8,4 |
| ● | SR | MR320SR_1 | MR320SR_2 | 9,0 |
| ● | OO | MR320OO_1 | MR320OO_2 | 8,4 |
| ● | OS | MR320OS_1 | MR320OS_2 | 9,0 |

PACKAGING

 L: 425 mm
D: 188 mm
H: 98 mm

1,1 kg

MARBLE

 White
Carrara

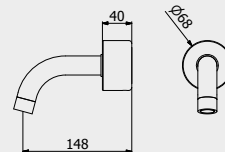
 Black
Marquina

PORTATE | WATER FLOW | DÉBIT D'EAU

| | | |
|---------|-------|-------|
| 1 BAR | 2 BAR | 3 BAR |
| 6,5 l/m | 8 l/m | 8 l/m |

ARTICLE | ARTICOLO | ARTICLE

MR321



Short wall mounted spout

Bocca d'erogazione corta a parete

Bec de remplissage mural court

CODE / COEFFICIENT | CODICE / COEFFICIENTE |
CODE / COEFFICIENT

| | | | | |
|---|----|-----------|-----------|-----|
| ● | CC | MR321CC_1 | MR321CC_2 | 5,9 |
| ● | PL | MR321PL_1 | MR321PL_2 | 9,4 |
| ● | SS | MR321SS_1 | MR321SS_2 | 7,4 |
| ● | ON | MR321ON_1 | MR321ON_2 | 5,9 |
| ● | BO | MR321BO_1 | MR321BO_2 | 7,1 |
| ● | NP | MR321NP_1 | MR321NP_2 | 7,1 |
| ● | CF | MR321CF_1 | MR321CF_2 | 8,9 |
| ● | CS | MR321CS_1 | MR321CS_2 | 9,4 |
| ● | II | MR321II_1 | MR321II_2 | 8,9 |
| ● | IS | MR321IS_1 | MR321IS_2 | 9,4 |
| ● | RS | MR321RS_1 | MR321RS_2 | 8,9 |
| ● | SR | MR321SR_1 | MR321SR_2 | 9,4 |
| ● | OO | MR321OO_1 | MR321OO_2 | 8,9 |
| ● | OS | MR321OS_1 | MR321OS_2 | 9,4 |

PACKAGING

 L: 425 mm
D: 188 mm
H: 98 mm

1 kg

MARBLE

 White
Carrara

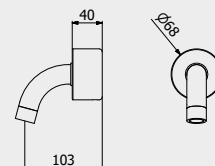
 Black
Marquina

PORTATE | WATER FLOW | DÉBIT D'EAU

| | | |
|---------|-------|-------|
| 1 BAR | 2 BAR | 3 BAR |
| 6,5 l/m | 8 l/m | 8 l/m |

ARTICLE | ARTICOLO | ARTICLE

MR322



Long wall mounted spout

Bocca d'erogazione lunga a parete

Bec de remplissage mural long

CODE / COEFFICIENT | CODICE / COEFFICIENTE |
CODE / COEFFICIENT

| | | | | |
|---|----|-----------|-----------|-----|
| ● | CC | MR322CC_1 | MR322CC_2 | 5,9 |
| ● | PL | MR322PL_1 | MR322PL_2 | 9,4 |
| ● | SS | MR322SS_1 | MR322SS_2 | 7,4 |
| ● | ON | MR322ON_1 | MR322ON_2 | 5,9 |
| ● | BO | MR322BO_1 | MR322BO_2 | 7,1 |
| ● | NP | MR322NP_1 | MR322NP_2 | 7,1 |
| ● | CF | MR322CF_1 | MR322CF_2 | 8,9 |
| ● | CS | MR322CS_1 | MR322CS_2 | 9,4 |
| ● | II | MR322II_1 | MR322II_2 | 8,9 |
| ● | IS | MR322IS_1 | MR322IS_2 | 9,4 |
| ● | RS | MR322RS_1 | MR322RS_2 | 8,9 |
| ● | SR | MR322SR_1 | MR322SR_2 | 9,4 |
| ● | OO | MR322OO_1 | MR322OO_2 | 8,9 |
| ● | OS | MR322OS_1 | MR322OS_2 | 9,4 |

PACKAGING

 L: 425 mm
D: 188 mm
H: 98 mm

1,2 kg

MARBLE

 White
Carrara

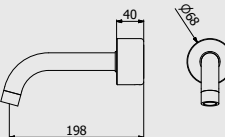
 Black
Marquina

PORTATE | WATER FLOW | DÉBIT D'EAU

| | | |
|---------|-------|-------|
| 1 BAR | 2 BAR | 3 BAR |
| 6,5 l/m | 8 l/m | 8 l/m |



ARTICLE | ARTICOLO | ARTICLE

MR706



Exposed parts for bidet spray complete with mixer
Set di parti esterne per Idroscopio igienico con miscelatore
Partie extérieure pour douchette hygiénique avec mitigeur

CODE / COEFFICIENT | CODICE / COEFFICIENTE |
CODE / COEFFICIENT

| | | | |
|----|-------------|-------------|------|
| CC | EMR706CC_19 | EMR706CC_20 | 11,6 |
| PL | EMR706PL_19 | EMR706PL_20 | 18,6 |
| SS | EMR706SS_19 | EMR706SS_20 | 14,5 |
| ON | EMR706ON_19 | EMR706ON_20 | 11,6 |
| BO | EMR706BO_19 | EMR706BO_20 | 13,9 |
| NP | EMR706NP_19 | EMR706NP_20 | 13,9 |
| CF | EMR706CF_19 | EMR706CF_20 | 17,4 |
| CS | EMR706CS_19 | EMR706CS_20 | 18,6 |
| II | EMR706II_19 | EMR706II_20 | 17,4 |
| IS | EMR706IS_19 | EMR706IS_20 | 18,6 |
| RS | EMR706RS_19 | EMR706RS_20 | 17,4 |
| SR | EMR706SR_19 | EMR706SR_20 | 18,6 |
| OO | EMR706OO_19 | EMR706OO_20 | 17,4 |
| OS | EMR706OS_19 | EMR706OS_20 | 18,6 |

PACKAGING
L: 370 mm
D: 270 mm
H: 80 mm

3,5 kg

MARBLE

White Carrara

Black Marquina

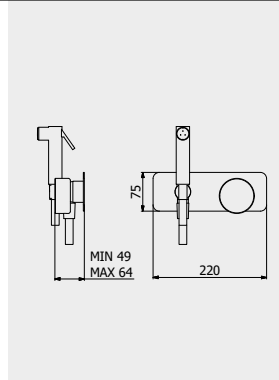

PORTATE | WATER FLOW | DÉBIT D'EAU

| | | |
|---------|---------|-------|
| 1 BAR | 2 BAR | 3 BAR |
| 2,3 l/m | 3,2 l/m | 4 l/m |

Marmo

Built-in body to be purchased separately

Corpo incasso da acquistare separatamente

Corps intégré à acheter séparément



CODICE | CODE | CODE

INC206XXXN_19

COEFFICIENT | COEFFICIENTE | COEFFICIENT

2,9

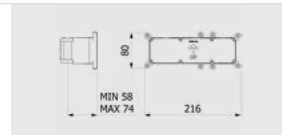

MARMO / ACCESSORIES COLLECTION



ARTICLE | ARTICOLO | ARTICLE

MR001



Soap-holder

Porta sapone

Porte de savon

CODE / COEFFICIENT | CODICE / COEFFICIENTE |
CODE / COEFFICIENTBlack
Marquina

MR001_1

White
Carrara

MR001_2

7,3

PACKAGING

 L: 265 mm
D: 260 mm
H: 70 mm

1,719 kg

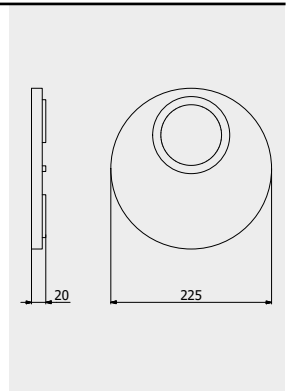

ARTICLE | ARTICOLO | ARTICLE

MR031



Dish soap holder

Portasapone e posaogetti

Porte- savon

CODE / COEFFICIENT | CODICE / COEFFICIENTE |
CODE / COEFFICIENTBlack
Marquina

MR031_1

White
Carrara

MR031_2

6,4

PACKAGING

 L: 340 mm
D: 180 mm
H: 70 mm

1,164 kg

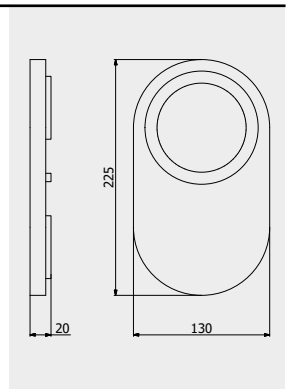

ARTICLE | ARTICOLO | ARTICLE

MR008



Robe Hook

Appendino a parete

Cintre

CODE / COEFFICIENT | CODICE / COEFFICIENTE |
CODE / COEFFICIENTBlack
Marquina

MR008_1

White
Carrara

MR008_2

3,0

PACKAGING

 L: 150 mm
D: 190 mm
H: 98 mm

0,367 kg

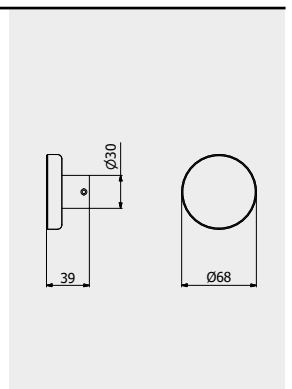



INDUSTRIA

Play the game of combinations.

Gioca al gioco delle combinazioni.
Joue les jeux des combinaisons

Collection of great versatility and taste, INDUSTRIA combines some more traditional and linear forms with the charm of the knurls that enhance its shape. Available in eleven different finishes, applied to the body or to the details of the base, and accessible for the entire range of bathroom products, from the faucet to the bath, Industria leaves a wide space to personal inventiveness, allowing the creation of unique combinations, for an original and fresh product.

Di grande versatilità e gusto, la collezione INDUSTRIA congiunge forme più tradizionali e lineari al fascino delle zigrinature che ne impreziosiscono la figura. Presente in undici finiture differenti, applicabili al corpo e ai dettagli della base, e disponibile per l'intera gamma di prodotti per bagno, dal lavabo al bordo vasca, Industria lascia ampio spazio all'estro personale, permettendo di realizzare combinazioni irripetibili, per un prodotto sempre inedito.

De grande versatilité et goût, la collection INDUSTRIA associe des formes plutôt traditionnelles et linéaires au charme des crénelages qui embellissent la silhouette. Disponible en onze finitions différentes, applicables au corps et aux détails de la base, et disponible pour toute la gamme de produits, du lavabo à la baignoire, Industria laisse large place à la créativité personnelle, permettant la création de combinaisons uniques, pour un produit inédit.



KITCHEN
AVAILABLE



CUSTOMIZABLE
FINISHING



LEAD FREE



ZINC FREE







↑ ID200S_4
 Monohole washbasin mixer
 Miscelatore lavabo monoforo
 Mitigeur lavabo complet

↙ ID200CC_1
 Monohole washbasin mixer
 Miscelatore lavabo monoforo
 Mitigeur lavabo complet

→ ID200CS_1
 Monohole washbasin mixer
 Miscelatore lavabo monoforo
 Mitigeur lavabo complet

ID202SS_5
 Tall monohole washbasin mixer
 Miscelatore lavabo monoforo alto
 Mitigeur lavabo haut







- ← ID200CC_1
Monohole washbasin mixer
Miscelatore lavabo monoforo
Mitigeur lavabo complet
- ↗ ID206CC_1
Wall mounted washbasin mixer
Miscelatore lavabo due fori a parete
Mitigeur lavabo mural
- ID206CC_4
Wall mounted washbasin mixer
Miscelatore lavabo due fori a parete
Mitigeur lavabo mural







← ID200SS_14
Monohole washbasin mixer
Miscelatore lavabo monoforo
Mitigeur lavabo complet

↑ ID200CC_1
Monohole washbasin mixer
Miscelatore lavabo monoforo
Mitigeur lavabo complet

→ ID314CC_1

Three ways wall shower mixer with shower kit
Miscelatore doccia a parete con deviatore tre vie e doccino integrato
Mitigeur douche mural 3 voies avec inverseur et douchette encastrée

↓ ID392CC_1

Three holes washbasin set with low spout
Lavabo tre fori a bocca bassa
Lavabo trois trous bec bas







↑ ID313CC_1

Two ways wall shower mixer with shower kit
Miscelatore doccia a parete con deviatore due
vie e doccino integrato
Mitigeur douche mural deux voies avec
inverseur et douchette encastrée

→ ID80000_5

Shower column with mixer and shower kit
Colonna doccia con miscelatore e e kit doccia
Colonne de douche avec mitigeur et kit douche



ARTICLE | ARTICOLO | ARTICLE

ID200



Monohole washbasin mixer complete with drain

Miscelatore lavabo monoforo completo di scarico automatico

Mitigeur lavabo complet avec bonde automatique

CODE / COEFFICIENT | CODICE / COEFFICIENTE | CODE / COEFFICIENT

BODY | CORPO | CORPS

LEVER | LEVA | LEVIER



+



| | | |
|----|---------|-----|
| CC | ID200CC | 6,2 |
| SS | ID200SS | 9,3 |
| ON | ID200ON | 6,2 |
| NP | ID200NP | 7,4 |
| CF | ID200CF | 9,3 |
| CS | ID200CS | 9,9 |
| II | ID200II | 9,3 |
| IS | ID200IS | 9,9 |
| RS | ID200RS | 9,3 |
| SR | ID200SR | 9,9 |
| OO | ID200OO | 9,3 |
| OS | ID200OS | 9,9 |



| | | |
|----|-----|-----|
| CC | _1 | 1,1 |
| SS | _2 | 1,6 |
| ON | _10 | 1,1 |
| NP | _13 | 1,3 |
| CF | _3 | 1,6 |
| CS | _4 | 1,7 |
| II | _8 | 1,6 |
| IS | _9 | 1,7 |
| RS | _7 | 1,6 |
| SR | _14 | 1,7 |
| OO | _5 | 1,6 |
| OS | _11 | 1,7 |

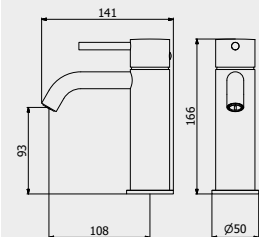

PORTATE | WATER FLOW | DÉBIT D'EAU

| 1 BAR | 2 BAR | 3 BAR |
|---------|---------|----------|
| 5,9 l/m | 8,4 l/m | 10,3 l/m |

PACKAGING

L: 340 mm
D: 180 mm
H: 70 mm

1,6 kg

ARTICLE | ARTICOLO | ARTICLE

ID202



Tall monohole washbasin mixer complete with drain

Miscelatore lavabo monoforo alto completo di scarico automatico

Mitigeur lavabo haut complet avec bonde automatique

CODE / COEFFICIENT | CODICE / COEFFICIENTE | CODE / COEFFICIENT

BODY | CORPO | CORPS

LEVER | LEVA | LEVIER



+



| | | |
|----|---------|------|
| CC | ID202CC | 9,3 |
| SS | ID202SS | 14,0 |
| ON | ID202ON | 9,3 |
| NP | ID202NP | 11,2 |
| CF | ID202CF | 14,0 |
| CS | ID202CS | 14,9 |
| II | ID202II | 14,0 |
| IS | ID202IS | 14,9 |
| RS | ID202RS | 14,0 |
| SR | ID202SR | 14,9 |
| OO | ID202OO | 14,0 |
| OS | ID202OS | 14,9 |



| | | |
|----|-----|-----|
| CC | _1 | 1,1 |
| SS | _2 | 1,6 |
| ON | _10 | 1,1 |
| NP | _13 | 1,3 |
| CF | _3 | 1,6 |
| CS | _4 | 1,7 |
| II | _8 | 1,6 |
| IS | _9 | 1,7 |
| RS | _7 | 1,6 |
| SR | _14 | 1,7 |
| OO | _5 | 1,6 |
| OS | _11 | 1,7 |

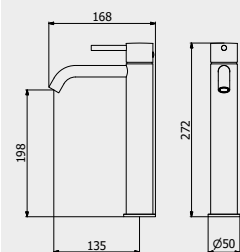

PORTATE | WATER FLOW | DÉBIT D'EAU

| 1 BAR | 2 BAR | 3 BAR |
|---------|---------|----------|
| 5,9 l/m | 8,4 l/m | 10,3 l/m |

PACKAGING

L: 425 mm
D: 188 mm
H: 98 mm

2,3 kg

ARTICLE | ARTICOLO | ARTICLE

ID206



Wall mounted washbasin mixer complete with drain

Miscelatore lavabo due fori a parete completo di scarico automatico

Mitigeur lavabo mural complet avec bonde automatique

CODE / COEFFICIENT | CODICE / COEFFICIENTE | CODE / COEFFICIENT

BODY | CORPO | CORPS

LEVER | LEVA | LEVIER



+



| | | |
|----|----------|------|
| CC | EID206CC | 8,0 |
| SS | EID206SS | 12,0 |
| ON | EID206ON | 8,0 |
| NP | EID206NP | 9,6 |
| CF | EID206CF | 12,0 |
| CS | EID206CS | 12,8 |
| II | EID206II | 12,0 |
| IS | EID206IS | 12,8 |
| RS | EID206RS | 12,0 |
| SR | EID206SR | 12,8 |
| OO | EID206OO | 12,0 |
| OS | EID206OS | 12,8 |



| | | |
|----|-----|-----|
| CC | _1 | 0,8 |
| SS | _2 | 1,2 |
| ON | _10 | 0,8 |
| NP | _13 | 1,0 |
| CF | _3 | 1,2 |
| CS | _4 | 1,3 |
| II | _8 | 1,2 |
| IS | _9 | 1,3 |
| RS | _7 | 1,2 |
| SR | _14 | 1,3 |
| OO | _5 | 1,2 |
| OS | _11 | 1,3 |

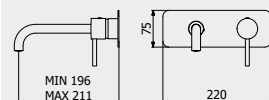

PORTATE | WATER FLOW | DÉBIT D'EAU

| 1 BAR | 2 BAR | 3 BAR |
|---------|----------|--------|
| 7,6 l/m | 10,5 l/m | 13 l/m |

PACKAGING

L: 265 mm
D: 260 mm
H: 70 mm

1,3 kg

Built-in body to be purchased separately

Corpo incasso da acquistare separatamente

Corps intégré à acheter séparément



CODICE | CODE | CODE

INC206XXXN_19

COEFFICIENT | COEFFICIENTE | COEFFICIENT

2,9

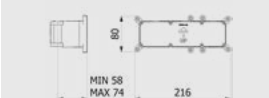

ARTICLE | ARTICOLO | ARTICLE

ID207



Wall mounted washbasin mixer with long spout complete with drain
 Miscelatore lavabo 2 fori a parete con bocca lunga completo di scarico
 Mitigeur lavabo mural bec long complet avec bonde automatique

CODE / COEFFICIENT | CODICE / COEFFICIENTE | CODE / COEFFICIENT

BODY | CORPO | CORPS

LEVER | LEVA | LEVIER



| | | | | | | | |
|--|----|----------|------|--|----|-----|-----|
| | CC | EID207CC | 8,4 | | CC | _1 | 0,8 |
| | SS | EID207SS | 12,6 | | SS | _2 | 1,2 |
| | ON | EID207ON | 8,4 | | ON | _10 | 0,8 |
| | NP | EID207NP | 10,1 | | NP | _13 | 1,0 |
| | CF | EID207CF | 12,6 | | CF | _3 | 1,2 |
| | CS | EID207CS | 13,4 | | CS | _4 | 1,3 |
| | II | EID207II | 12,6 | | II | _8 | 1,2 |
| | IS | EID207IS | 13,4 | | IS | _9 | 1,3 |
| | RS | EID207RS | 12,6 | | RS | _7 | 1,2 |
| | SR | EID207SR | 13,4 | | SR | _14 | 1,3 |
| | OO | EID207OO | 12,6 | | OO | _5 | 1,2 |
| | OS | EID207OS | 13,4 | | OS | _11 | 1,3 |

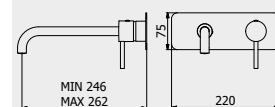

PORTATE | WATER FLOW | DÉBIT D'EAU

| | | |
|---------|----------|--------|
| 1 BAR | 2 BAR | 3 BAR |
| 7,6 l/m | 10,5 l/m | 13 l/m |

PACKAGING

| | | | |
|--|-----------|--|--------|
| | L: 265 mm | | 1,3 kg |
| | D: 260 mm | | |
| | H: 70 mm | | |

Industria

Built-in body to be purchased separately

Corpo incasso da acquistare separatamente

Corps intégré à acheter séparément



CODICE | CODE | CODE

INC206XXXN_19

COEFFICIENT | COEFFICIENTE | COEFFICIENT

2,9



ARTICLE | ARTICOLO | ARTICLE

ID208



Wall mounted washbasin mixer with short spout complete with drain
 Miscelatore lavabo 2 fori a parete con bocca corta completo di scarico
 Mitigeur lavabo mural bec court complet avec bonde automatique

CODE / COEFFICIENT | CODICE / COEFFICIENTE | CODE / COEFFICIENT

BODY | CORPO | CORPS

LEVER | LEVA | LEVIER



| | | | | | | | |
|--|----|----------|------|--|----|-----|-----|
| | CC | EID208CC | 8,4 | | CC | _1 | 0,8 |
| | SS | EID208SS | 12,6 | | SS | _2 | 1,2 |
| | ON | EID208ON | 8,4 | | ON | _10 | 0,8 |
| | NP | EID208NP | 10,1 | | NP | _13 | 1,0 |
| | CF | EID208CF | 12,6 | | CF | _3 | 1,2 |
| | CS | EID208CS | 13,4 | | CS | _4 | 1,3 |
| | II | EID208II | 12,6 | | II | _8 | 1,2 |
| | IS | EID208IS | 13,4 | | IS | _9 | 1,3 |
| | RS | EID208RS | 12,6 | | RS | _7 | 1,2 |
| | SR | EID208SR | 13,4 | | SR | _14 | 1,3 |
| | OO | EID208OO | 12,6 | | OO | _5 | 1,2 |
| | OS | EID208OS | 13,4 | | OS | _11 | 1,3 |

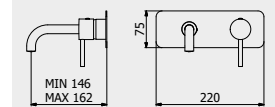

PORTATE | WATER FLOW | DÉBIT D'EAU

| | | |
|---------|----------|--------|
| 1 BAR | 2 BAR | 3 BAR |
| 7,6 l/m | 10,5 l/m | 13 l/m |

PACKAGING

| | | | |
|--|-----------|--|--------|
| | L: 265 mm | | 1,3 kg |
| | D: 260 mm | | |
| | H: 70 mm | | |

Built-in body to be purchased separately

Corpo incasso da acquistare separatamente

Corps intégré à acheter séparément



CODICE | CODE | CODE

INC206XXXN_19

COEFFICIENT | COEFFICIENTE | COEFFICIENT

2,9



ARTICLE | ARTICOLO | ARTICLE

ID210

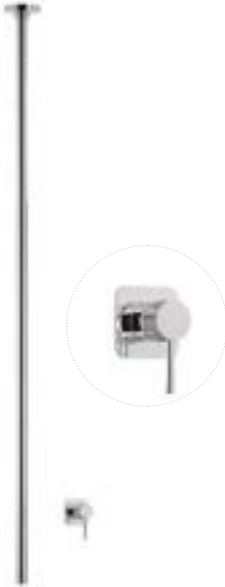

Ceiling spout with wall mounted mixer

Bocca da soffitto con comando remoto ad incasso

Mitigeur lavabo mural avec bec plafond complet avec bonde automatique

CODE / COEFFICIENT | CODICE / COEFFICIENTE | CODE / COEFFICIENT

BODY | CORPO | CORPS

LEVER | LEVA | LEVIER

| | | | | | |
|------|----------|------|------|-----|-----|
| ● CC | EID210CC | 25,0 | ● CC | _1 | 0,9 |
| ● SS | EID210SS | 37,5 | ● SS | _2 | 1,4 |
| ● ON | EID210ON | 25,0 | ● ON | _10 | 0,9 |
| ● NP | EID210NP | 30,0 | ● NP | _13 | 1,1 |
| ● CF | EID210CF | 37,5 | ● CF | _3 | 1,4 |
| ● CS | EID210CS | 40,0 | ● CS | _4 | 1,5 |
| ● II | EID210II | 37,5 | ● II | _8 | 1,4 |
| ● IS | EID210IS | 40,0 | ● IS | _9 | 1,5 |
| ● RS | EID210RS | 37,5 | ● RS | _7 | 1,4 |
| ● SR | EID210SR | 40,0 | ● SR | _14 | 1,5 |
| ● OO | EID210OO | 37,5 | ● OO | _5 | 1,4 |
| ● OS | EID210OS | 40,0 | ● OS | _11 | 1,5 |

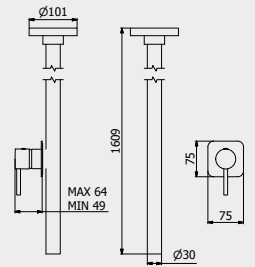

PORTATE | WATER FLOW | DÉBIT D'EAU

| | | |
|---------|---------|---------|
| 1 BAR | 2 BAR | 3 BAR |
| 4,3 l/m | 5,2 l/m | 6,9 l/m |

PACKAGING

L: 150 mm
D: 190 mm
H: 98 mm

L: 1700 mm
Ø: 70 mm
4,5 kg

Built-in body to be purchased separately

Corpo incasso da acquistare separatamente

Corps intégré à acheter séparément



CODICE | CODE | CODE

INC300XXXN_19

COEFFICIENT | COEFFICIENTE | COEFFICIENT

1,8

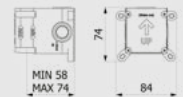

ARTICLE | ARTICOLO | ARTICLE

ID299



Monohole free-standing washbasin mixer complete with drain

Miscelatore lavabo da terra completo di scarico automatico

Mitigeur Lavabo Free standing complet avec bonde automatique

CODE / COEFFICIENT | CODICE / COEFFICIENTE | CODE / COEFFICIENT

BODY | CORPO | CORPS

LEVER | LEVA | LEVIER

| | | | | | |
|------|----------|------|------|-----|-----|
| ● CC | EID299CC | 28,3 | ● CC | _1 | 1,1 |
| ● SS | EID299SS | 42,4 | ● SS | _2 | 1,6 |
| ● ON | EID299ON | 28,3 | ● ON | _10 | 1,1 |
| ● NP | EID299NP | 33,9 | ● NP | _13 | 1,3 |
| ● CF | EID299CF | 42,4 | ● CF | _3 | 1,6 |
| ● CS | EID299CS | 45,2 | ● CS | _4 | 1,7 |
| ● II | EID299II | 42,4 | ● II | _8 | 1,6 |
| ● IS | EID299IS | 45,2 | ● IS | _9 | 1,7 |
| ● RS | EID299RS | 42,4 | ● RS | _7 | 1,6 |
| ● SR | EID299SR | 45,2 | ● SR | _14 | 1,7 |
| ● OO | EID299OO | 42,4 | ● OO | _5 | 1,6 |
| ● OS | EID299OS | 45,2 | ● OS | _11 | 1,7 |

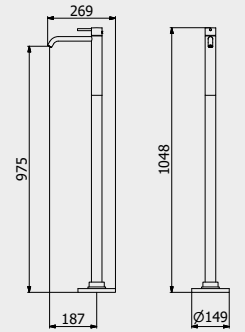

PORTATE | WATER FLOW | DÉBIT D'EAU

| | | |
|---------|---------|---------|
| 1 BAR | 2 BAR | 3 BAR |
| 5,5 l/m | 7,8 l/m | 9,6 l/m |

PACKAGING

L: 1100 mm
D: 395 mm
H: 150 mm

15,6 kg

Built-in body to be purchased separately
AVAILABLE FROM JANUARY 2020

Corpo incasso da acquistare separatamente
DISPONIBILE DA GENNAIO 2020

Corps intégré à acheter séparément
DISPONIBLE À PARTIR DE JANVIER 2020



CODICE | CODE | CODE

INC399XXXN_19

COEFFICIENT | COEFFICIENTE | COEFFICIENT

2,8

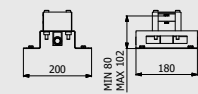

ARTICLE | ARTICOLO | ARTICLE

ID392



Three holes washbasin set with low spout

Lavabo tre fori a bocca bassa completo di scarico automatico

Lavabo trois trous bec bas

CODE / COEFFICIENT | CODICE / COEFFICIENTE | CODE / COEFFICIENT

BODY | CORPO | CORPS

LEVER | LEVA | LEVIER

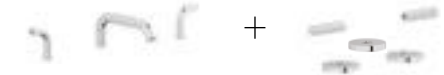

| | | |
|----|---------|------|
| CC | ID392CC | 10,6 |
| SS | ID392SS | 15,9 |
| ON | ID392ON | 10,6 |
| NP | ID392NP | 12,8 |
| CF | ID392CF | 15,9 |
| CS | ID392CS | 17,0 |
| II | ID392II | 15,9 |
| IS | ID392IS | 17,0 |
| RS | ID392RS | 15,9 |
| SR | ID392SR | 17,0 |
| OO | ID392OO | 15,9 |
| OS | ID392OS | 17,0 |

| | | |
|----|-----|-----|
| CC | _1 | 1,9 |
| SS | _2 | 2,9 |
| ON | _10 | 1,9 |
| NP | _13 | 2,3 |
| CF | _3 | 2,9 |
| CS | _4 | 3,1 |
| II | _8 | 2,9 |
| IS | _9 | 3,1 |
| RS | _7 | 2,9 |
| SR | _14 | 3,1 |
| OO | _5 | 2,9 |
| OS | _11 | 3,1 |

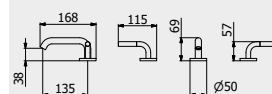

PORTATE | WATER FLOW | DÉBIT D'EAU

| | | |
|---------|-------|-------|
| 1 BAR | 2 BAR | 3 BAR |
| 5,5 l/m | 6 l/m | 6 l/m |

PACKAGING

| | |
|-----------|------|
| L: 370 mm | 3 kg |
| D: 270 mm | |
| H: 80 mm | |

Industria

ARTICLE | ARTICOLO | ARTICLE

ID394



Two pieces washbasin mixer

Miscelatore lavabo due fori

Mitigeur lavabo deux piece

CODE / COEFFICIENT | CODICE / COEFFICIENTE | CODE / COEFFICIENT

BODY | CORPO | CORPS

LEVER | LEVA | LEVIER

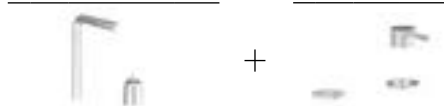

| | | |
|----|---------|------|
| CC | ID394CC | 8,0 |
| SS | ID394SS | 12,0 |
| ON | ID394ON | 8,0 |
| NP | ID394NP | 9,6 |
| CF | ID394CF | 12,0 |
| CS | ID394CS | 12,8 |
| II | ID394II | 12,0 |
| IS | ID394IS | 12,8 |
| RS | ID394RS | 12,0 |
| SR | ID394SR | 12,8 |
| OO | ID394OO | 12,0 |
| OS | ID394OS | 12,8 |

| | | |
|----|-----|-----|
| CC | _1 | 1,5 |
| SS | _2 | 2,3 |
| ON | _10 | 1,5 |
| NP | _13 | 1,8 |
| CF | _3 | 2,3 |
| CS | _4 | 2,4 |
| II | _8 | 2,3 |
| IS | _9 | 2,4 |
| RS | _7 | 2,3 |
| SR | _14 | 2,4 |
| OO | _5 | 2,3 |
| OS | _11 | 2,4 |

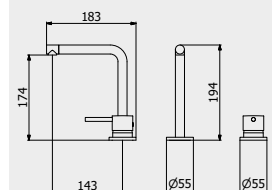

PORTATE | WATER FLOW | DÉBIT D'EAU

| | | |
|---------|-------|-------|
| 1 BAR | 2 BAR | 3 BAR |
| 4,5 l/m | 5 l/m | 5 l/m |

PACKAGING

| | |
|-----------|--------|
| L: 360 mm | 2,3 kg |
| D: 220 mm | |
| H: 150 mm | |

ARTICLE | ARTICOLO | ARTICLE

ID220



Monohole bidet mixer complete with drain

Miscelatore bidet monoforo completo di scarico automatico

Mitigeur bidet complet avec bonde automatique

CODE / COEFFICIENT | CODICE / COEFFICIENTE | CODE / COEFFICIENT

BODY | CORPO | CORPS

LEVER | LEVA | LEVIER

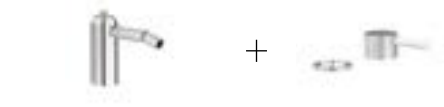

| | | |
|----|---------|-----|
| CC | ID220CC | 6,2 |
| SS | ID220SS | 9,3 |
| ON | ID220ON | 6,2 |
| NP | ID220NP | 7,4 |
| CF | ID220CF | 9,3 |
| CS | ID220CS | 9,9 |
| II | ID220II | 9,3 |
| IS | ID220IS | 9,9 |
| RS | ID220RS | 9,3 |
| SR | ID220SR | 9,9 |
| OO | ID220OO | 9,3 |
| OS | ID220OS | 9,9 |

| | | |
|----|-----|-----|
| CC | _1 | 1,1 |
| SS | _2 | 1,6 |
| ON | _10 | 1,1 |
| NP | _13 | 1,3 |
| CF | _3 | 1,6 |
| CS | _4 | 1,7 |
| II | _8 | 1,6 |
| IS | _9 | 1,7 |
| RS | _7 | 1,6 |
| SR | _14 | 1,7 |
| OO | _5 | 1,6 |
| OS | _11 | 1,7 |

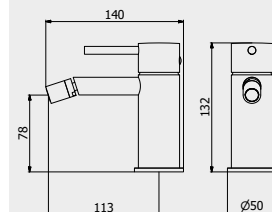

PORTATE | WATER FLOW | DÉBIT D'EAU

| | | |
|---------|---------|----------|
| 1 BAR | 2 BAR | 3 BAR |
| 5,9 l/m | 8,4 l/m | 10,3 l/m |

PACKAGING

| | |
|-----------|--------|
| L: 340 mm | 1,6 kg |
| D: 180 mm | |
| H: 70 mm | |

ARTICLE | ARTICOLO | ARTICLE

ID300



Exposed parts for manual wall mixer

Set di parti esterne per miscelatore a parete ad una via

Partie extérieure pour mitigeur encastré à une voie

CODE / COEFFICIENT | CODICE / COEFFICIENTE | CODE / COEFFICIENT

BODY | CORPO | CORPS

LEVER | LEVA | LEVIER

| | | | | | | | |
|--|----|----------|-----|--|----|-----|-----|
| | CC | EID300CC | 3,0 | | CC | _1 | 1,1 |
| | SS | EID300SS | 4,5 | | SS | _2 | 1,7 |
| | ON | EID300ON | 3,0 | | ON | _10 | 1,1 |
| | NP | EID300NP | 3,6 | | NP | _13 | 1,3 |
| | CF | EID300CF | 4,5 | | CF | _3 | 1,7 |
| | CS | EID300CS | 4,8 | | CS | _4 | 1,8 |
| | II | EID300II | 4,5 | | II | _8 | 1,7 |
| | IS | EID300IS | 4,8 | | IS | _9 | 1,8 |
| | RS | EID300RS | 4,5 | | RS | _7 | 1,7 |
| | SR | EID300SR | 4,8 | | SR | _14 | 1,8 |
| | OO | EID300OO | 4,5 | | OO | _5 | 1,7 |
| | OS | EID300OS | 4,8 | | OS | _11 | 1,8 |

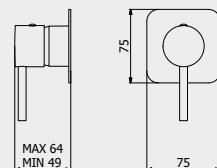

PORTATE | WATER FLOW | DÉBIT D'EAU

| | | |
|----------|----------|--------|
| 1 BAR | 2 BAR | 3 BAR |
| 11,5 l/m | 16,3 l/m | 20 l/m |

PACKAGING

L: 150 mm
D: 190 mm
H: 98 mm

1,4 kg

Built-in body to be purchased separately

Corpo incasso da acquistare separatamente

Corps intégré à acheter séparément



CODICE | CODE | CODE

INC300XXXN_19

COEFFICIENT | COEFFICIENTE | COEFFICIENT

1,8



ARTICLE | ARTICOLO | ARTICLE

ID310



Exposed parts for manual wall mixer with two ways diverter

Miscelatore doccia a parete con deviatore due vie

Mitigeur douche mural deux voies avec inverseur

CODE / COEFFICIENT | CODICE / COEFFICIENTE | CODE / COEFFICIENT

BODY | CORPO | CORPS

LEVER | LEVA | LEVIER

| | | | | | | | |
|--|----|----------|-----|--|----|-----|-----|
| | CC | EID310CC | 4,3 | | CC | _1 | 1,8 |
| | SS | EID310SS | 6,5 | | SS | _2 | 2,7 |
| | ON | EID310ON | 4,3 | | ON | _10 | 1,8 |
| | NP | EID310NP | 5,2 | | NP | _13 | 2,2 |
| | CF | EID310CF | 6,5 | | CF | _3 | 2,7 |
| | CS | EID310CS | 6,9 | | CS | _4 | 2,9 |
| | II | EID310II | 6,5 | | II | _8 | 2,7 |
| | IS | EID310IS | 6,9 | | IS | _9 | 2,9 |
| | RS | EID310RS | 6,5 | | RS | _7 | 2,7 |
| | SR | EID310SR | 6,9 | | SR | _14 | 2,9 |
| | OO | EID310OO | 6,5 | | OO | _5 | 2,7 |
| | OS | EID310OS | 6,9 | | OS | _11 | 2,9 |

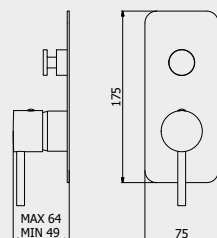

PORTATE | WATER FLOW | DÉBIT D'EAU

| | | |
|---------|----------|--------|
| 1 BAR | 2 BAR | 3 BAR |
| 9,2 l/m | 12,8 l/m | 16 l/m |

PACKAGING

L: 150 mm
D: 190 mm
H: 98 mm

1,4 kg

Built-in body to be purchased separately

Corpo incasso da acquistare separatamente

Corps intégré à acheter séparément



CODICE | CODE | CODE

INC310XXXN_19

COEFFICIENT | COEFFICIENTE | COEFFICIENT

3,3

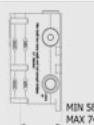

ARTICLE | ARTICOLO | ARTICLE

ID312



Exposed parts for manual wall mixer with three ways diverter
Set di parti esterne per miscelatore a parete a tre vie
Mitigeur douche mural trois voies avec inverseur

CODE / COEFFICIENT | CODICE / COEFFICIENTE | CODE / COEFFICIENT

BODY | CORPO | CORPS

LEVER | LEVA | LEVIER



| Color | Code | Price | Color | Code | Price |
|-----------|-------------|-------|-----------|--------|-------|
| White | CC EID312CC | 5,6 | White | CC _1 | 1,8 |
| Grey | SS EID312SS | 8,4 | Grey | SS _2 | 2,7 |
| Yellow | ON EID312ON | 5,6 | Yellow | ON _10 | 1,8 |
| Black | NP EID312NP | 6,7 | Black | NP _13 | 2,2 |
| Dark Grey | CF EID312CF | 8,4 | Dark Grey | CF _3 | 2,7 |
| Dark Grey | CS EID312CS | 9,0 | Dark Grey | CS _4 | 2,9 |
| Yellow | II EID312II | 8,4 | Yellow | II _8 | 2,7 |
| Yellow | IS EID312IS | 9,0 | Yellow | IS _9 | 2,9 |
| Orange | RS EID312RS | 8,4 | Orange | RS _7 | 2,9 |
| Orange | SR EID312SR | 9,0 | Orange | SR _14 | 2,9 |
| Yellow | OO EID312OO | 8,4 | Yellow | OO _5 | 2,7 |
| Yellow | OS EID312OS | 9,0 | Yellow | OS _11 | 2,9 |

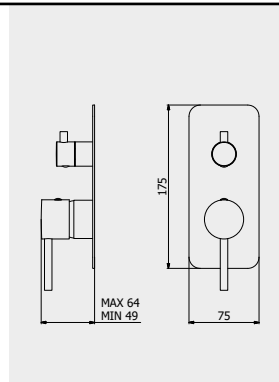

PORTATE | WATER FLOW | DÉBIT D'EAU

| 1 BAR | 2 BAR | 3 BAR |
|---------|----------|----------|
| 8,3 l/m | 11,7 l/m | 14,3 l/m |

PACKAGING

L: 150 mm
D: 190 mm
H: 98 mm

Weight: 1,4 kg

Industria

Built-in body to be purchased separately

Corpo incasso da acquistare separatamente

Corps intégré à acheter séparément



CODICE | CODE | CODE

INC312XXXN_19

COEFFICIENT | COEFFICIENTE | COEFFICIENT

3,3

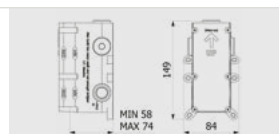

ARTICLE | ARTICOLO | ARTICLE

ID313



Two ways wall shower mixer complete with shower kit
Miscelatore doccia a parete con deviatore due vie e doccino integrato
Mitigeur douche mural 2 voies avec inverseur et douchette encastrée

CODE / COEFFICIENT | CODICE / COEFFICIENTE | CODE / COEFFICIENT

BODY | CORPO | CORPS

LEVER | LEVA | LEVIER



| Color | Code | Price | Color | Code | Price |
|-----------|-------------|-------|-----------|--------|-------|
| White | CC EID313CC | 6,6 | White | CC _1 | 3,8 |
| Grey | SS EID313SS | 9,9 | Grey | SS _2 | 5,7 |
| Yellow | ON EID313ON | 6,6 | Yellow | ON _10 | 3,8 |
| Black | NP EID313NP | 7,9 | Black | NP _13 | 4,6 |
| Dark Grey | CF EID313CF | 9,9 | Dark Grey | CF _3 | 5,7 |
| Dark Grey | CS EID313CS | 10,6 | Dark Grey | CS _4 | 6,1 |
| Yellow | II EID313II | 9,9 | Yellow | II _8 | 5,7 |
| Yellow | IS EID313IS | 10,6 | Yellow | IS _9 | 6,1 |
| Orange | RS EID313RS | 9,9 | Orange | RS _7 | 5,7 |
| Orange | SR EID313SR | 10,6 | Orange | SR _14 | 6,1 |
| Yellow | OO EID313OO | 9,9 | Yellow | OO _5 | 5,7 |
| Yellow | OS EID313OS | 10,6 | Yellow | OS _11 | 6,1 |

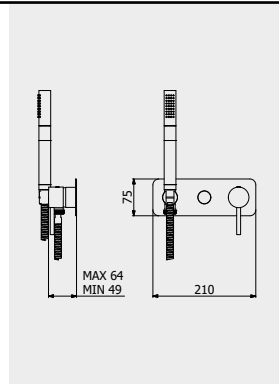

PORTATE | WATER FLOW | DÉBIT D'EAU

| 1 BAR | 2 BAR | 3 BAR |
|--------|----------|----------|
| 10 l/m | 14,1 l/m | 17,2 l/m |

PACKAGING

L: 370 mm
D: 270 mm
H: 80 mm

Weight: 2,2 kg

Built-in body to be purchased separately

Corpo incasso da acquistare separatamente

Corps intégré à acheter séparément



CODICE | CODE | CODE

INC313XXXN_19

COEFFICIENT | COEFFICIENTE | COEFFICIENT

3,6

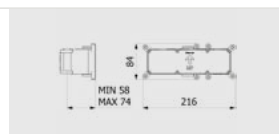

ARTICLE | ARTICOLO | ARTICLE

ID314



Three ways wall shower mixer complete with shower kit

Miscelatore doccia a parete con deviatore tre vie e doccino integrato

Mitigeur douche mural 3 voies avec inverseur et douchette encastrée

CODE / COEFFICIENT | CODICE / COEFFICIENTE | CODE / COEFFICIENT

BODY | CORPO | CORPS

LEVER | LEVA | LEVIER



+



| | | |
|------|----------|------|
| ● CC | EID314CC | 8,0 |
| ● SS | EID314SS | 12,0 |
| ● ON | EID314ON | 8,0 |
| ● NP | EID314NP | 9,6 |
| ● CF | EID314CF | 12,0 |
| ● CS | EID314CS | 12,8 |
| ● II | EID314II | 12,0 |
| ● IS | EID314IS | 12,8 |
| ● RS | EID314RS | 12,0 |
| ● SR | EID314SR | 12,8 |
| ● OO | EID314OO | 12,0 |
| ● OS | EID314OS | 12,8 |



| | | |
|------|-----|-----|
| ● CC | _1 | 3,8 |
| ● SS | _2 | 5,7 |
| ● ON | _10 | 3,8 |
| ● NP | _13 | 4,6 |
| ● CF | _3 | 5,7 |
| ● CS | _4 | 6,1 |
| ● II | _8 | 5,7 |
| ● IS | _9 | 6,1 |
| ● RS | _7 | 5,7 |
| ● SR | _14 | 6,1 |
| ● OO | _5 | 5,7 |
| ● OS | _11 | 6,1 |

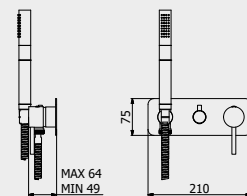

PORTATE | WATER FLOW | DÉBIT D'EAU

| | | |
|---------|----------|----------|
| 1 BAR | 2 BAR | 3 BAR |
| 8,3 l/m | 11,7 l/m | 14,3 l/m |

PACKAGING

L: 370 mm
D: 270 mm
H: 80 mm

2,2 kg

Built-in body to be purchased separately

Corpo incasso da acquistare separatamente

Corps intégré à acheter séparément



CODICE | CODE | CODE

INC314XXXN_19

COEFFICIENT | COEFFICIENTE | COEFFICIENT

3,7



ARTICLE | ARTICOLO | ARTICLE

ID350



Wall mounted shower mixer with shower kit

Doccia esterno a parete completo di kit doccia

Mitigeur de douche externe avec flexible et douchette

CODE / COEFFICIENT | CODICE / COEFFICIENTE | CODE / COEFFICIENT

BODY | CORPO | CORPS

LEVER | LEVA | LEVIER



+



| | | |
|------|---------|------|
| ● CC | ID350CC | 9,7 |
| ● SS | ID350SS | 14,5 |
| ● ON | ID350ON | 9,7 |
| ● NP | ID350NP | 11,6 |
| ● CF | ID350CF | 14,5 |
| ● CS | ID350CS | 15,5 |
| ● II | ID350II | 14,5 |
| ● IS | ID350IS | 15,5 |
| ● RS | ID350RS | 14,5 |
| ● SR | ID350SR | 15,5 |
| ● OO | ID350OO | 14,5 |
| ● OS | ID350OS | 15,5 |



| | | |
|------|-----|-----|
| ● CC | _1 | 3,9 |
| ● SS | _2 | 5,9 |
| ● ON | _10 | 3,9 |
| ● NP | _13 | 4,7 |
| ● CF | _3 | 5,9 |
| ● CS | _4 | 6,3 |
| ● II | _8 | 5,9 |
| ● IS | _9 | 6,3 |
| ● RS | _7 | 5,9 |
| ● SR | _14 | 6,3 |
| ● OO | _5 | 5,9 |
| ● OS | _11 | 6,3 |

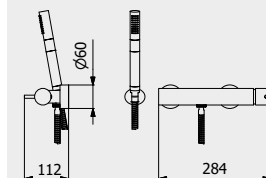

PORTATE | WATER FLOW | DÉBIT D'EAU

| | | |
|----------|----------|--------|
| 1 BAR | 2 BAR | 3 BAR |
| 12,5 l/m | 17,5 l/m | 21 l/m |

PACKAGING

L: 370 mm
D: 270 mm
H: 80 mm

3,9 kg

ARTICLE | ARTICOLO | ARTICLE

ID250



Wall mounted bath filler complete with hand shower kit

Bordo vasca esterno a parete completo di kit doccia

Mitigeur Bain mural avec douchette encastrée

CODE / COEFFICIENT | CODICE / COEFFICIENTE | CODE / COEFFICIENT

BODY | CORPO | CORPS

LEVER | LEVA | LEVIER



+



| | | |
|------|---------|------|
| ● CC | ID250CC | 11,0 |
| ● SS | ID250SS | 16,5 |
| ● ON | ID250ON | 11,0 |
| ● NP | ID250NP | 13,2 |
| ● CF | ID250CF | 16,5 |
| ● CS | ID250CS | 17,6 |
| ● II | ID250II | 16,5 |
| ● IS | ID250IS | 17,6 |
| ● RS | ID250RS | 16,5 |
| ● SR | ID250SR | 17,6 |
| ● OO | ID250OO | 16,5 |
| ● OS | ID250OS | 17,6 |



| | | |
|------|-----|-----|
| ● CC | _1 | 3,9 |
| ● SS | _2 | 5,9 |
| ● ON | _10 | 3,9 |
| ● NP | _13 | 4,7 |
| ● CF | _3 | 5,9 |
| ● CS | _4 | 6,3 |
| ● II | _8 | 5,9 |
| ● IS | _9 | 6,3 |
| ● RS | _7 | 5,9 |
| ● SR | _14 | 6,3 |
| ● OO | _5 | 5,9 |
| ● OS | _11 | 6,3 |

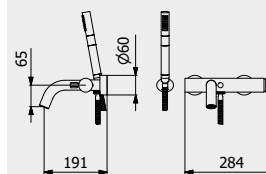

PORTATE | WATER FLOW | DÉBIT D'EAU

| | | |
|--------|----------|--------|
| 1 BAR | 2 BAR | 3 BAR |
| 10 l/m | 14,3 l/m | 18 l/m |

PACKAGING

L: 370 mm
D: 270 mm
H: 80 mm

4,2 kg



ARTICLE | ARTICOLO | ARTICLE

ID396



Four holes deck mounted bath filler with shower kit
Bordo vasca quattro fori con deviatore e kit doccia
Bain quatre trous avec inverseur et Kit Douche

CODE / COEFFICIENT | CODICE / COEFFICIENTE | CODE / COEFFICIENT

BODY | CORPO | CORPS

LEVER | LEVA | LEVIER



| | | | | | |
|----|---------|------|----|-----|-----|
| CC | ID396CC | 12,6 | CC | _1 | 6,0 |
| SS | ID396SS | 18,8 | SS | _2 | 8,9 |
| ON | ID396ON | 12,6 | ON | _10 | 6,0 |
| NP | ID396NP | 15,1 | NP | _13 | 7,1 |
| CF | ID396CF | 18,8 | CF | _3 | 8,9 |
| CS | ID396CS | 20,1 | CS | _4 | 9,5 |
| II | ID396II | 18,8 | II | _8 | 8,9 |
| IS | ID396IS | 20,1 | IS | _9 | 9,5 |
| RS | ID396RS | 18,8 | RS | _7 | 8,9 |
| SR | ID396SR | 20,1 | SR | _14 | 9,5 |
| OO | ID396OO | 18,8 | OO | _5 | 8,9 |
| OS | ID396OS | 20,1 | OS | _11 | 9,5 |

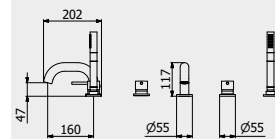

| PORTATE WATER FLOW DÉBIT D'EAU | | |
|------------------------------------|----------|----------|
| 1 BAR | 2 BAR | 3 BAR |
| 9,3 l/m | 13,2 l/m | 16,2 l/m |

PACKAGING

L: 400 mm
D: 250 mm
H: 140 mm

4 kg

Industria

ARTICLE | ARTICOLO | ARTICLE

ID397



3 holes bath filler with overflow outlet connection, diverter and shower kit
Bordo vasca tre fori per colonna riempimento con deviatore e kit doccia
Bain trois trous avec inverseur et Kit Douche pour remplissage ETP

CODE / COEFFICIENT | CODICE / COEFFICIENTE | CODE / COEFFICIENT

BODY | CORPO | CORPS

LEVER | LEVA | LEVIER



| | | | | | |
|----|---------|------|----|-----|-----|
| CC | ID397CC | 12,6 | CC | _1 | 4,7 |
| SS | ID397SS | 18,8 | SS | _2 | 7,0 |
| ON | ID397ON | 12,6 | ON | _10 | 4,7 |
| NP | ID397NP | 15,1 | NP | _13 | 5,6 |
| CF | ID397CF | 18,8 | CF | _3 | 7,0 |
| CS | ID397CS | 20,1 | CS | _4 | 7,5 |
| II | ID397II | 18,8 | II | _8 | 7,0 |
| IS | ID397IS | 20,1 | IS | _9 | 7,5 |
| RS | ID397RS | 18,8 | RS | _7 | 7,0 |
| SR | ID397SR | 20,1 | SR | _14 | 7,5 |
| OO | ID397OO | 18,8 | OO | _5 | 7,0 |
| OS | ID397OS | 20,1 | OS | _11 | 7,5 |

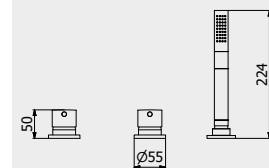

| PORTATE WATER FLOW DÉBIT D'EAU | | |
|------------------------------------|--------|--------|
| 1 BAR | 2 BAR | 3 BAR |
| 12 l/m | 17 l/m | 22 l/m |

PACKAGING

L: 370 mm
D: 270 mm
H: 80 mm

3,2 kg

ARTICLE | ARTICOLO | ARTICLE

ID398



Two ways wall shower mixer with spout
Miscelatore doccia a parete con bocca
Mitigeur douche mural avec bec

CODE / COEFFICIENT | CODICE / COEFFICIENTE | CODE / COEFFICIENT

BODY | CORPO | CORPS

LEVER | LEVA | LEVIER



| | | | | | |
|----|----------|------|----|-----|-----|
| CC | EID398CC | 9,3 | CC | _1 | 4,2 |
| SS | EID398SS | 13,9 | SS | _2 | 6,3 |
| ON | EID398ON | 9,3 | ON | _10 | 4,2 |
| NP | EID398NP | 11,1 | NP | _13 | 5,1 |
| CF | EID398CF | 13,9 | CF | _3 | 6,3 |
| CS | EID398CS | 14,8 | CS | _4 | 6,8 |
| II | EID398II | 13,9 | II | _8 | 6,3 |
| IS | EID398IS | 14,8 | IS | _9 | 6,8 |
| RS | EID398RS | 13,9 | RS | _7 | 6,3 |
| SR | EID398SR | 14,8 | SR | _14 | 6,8 |
| OO | EID398OO | 13,9 | OO | _5 | 6,3 |
| OS | EID398OS | 14,8 | OS | _11 | 6,8 |

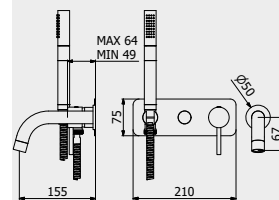

| PORTATE WATER FLOW DÉBIT D'EAU | | |
|------------------------------------|----------|----------|
| 10 l/m | 14,1 l/m | 17,2 l/m |

PACKAGING

L: 470 mm
D: 290 mm
H: 160 mm

4,8 kg

Built-in body to be purchased separately
Corpo incasso da acquistare separatamente
Corps intégré à acheter séparément



CODICE | CODE | CODE

INC313XXXN_19

COEFFICIENT | COEFFICIENTE | COEFFICIENT

3,6



ARTICLE | ARTICOLO | ARTICLE

ID399



Floormount tub filler with hand shower

Bordo vasca da pavimento con doccetta

Robinet de bain au sol avec douchette

CODE / COEFFICIENT | CODICE / COEFFICIENTE | CODE / COEFFICIENT

BODY | CORPO | CORPS

LEVER | LEVA | LEVIER



+



| | | |
|------|----------|------|
| ● CC | EID399CC | 28,5 |
| ● SS | EID399SS | 42,8 |
| ● ON | EID399ON | 28,5 |
| ● NP | EID399NP | 34,2 |
| ● CF | EID399CF | 42,8 |
| ● CS | EID399CS | 45,6 |
| ● II | EID399II | 42,8 |
| ● IS | EID399IS | 45,6 |
| ● RS | EID399RS | 42,8 |
| ● SR | EID399SR | 45,6 |
| ● OO | EID399OO | 42,8 |
| ● OS | EID399OS | 45,6 |



| | | |
|------|-----|-----|
| ● CC | _1 | 2,9 |
| ● SS | _2 | 4,3 |
| ● ON | _10 | 2,9 |
| ● NP | _13 | 3,5 |
| ● CF | _3 | 4,3 |
| ● CS | _4 | 4,6 |
| ● II | _8 | 4,3 |
| ● IS | _9 | 4,6 |
| ● RS | _7 | 4,3 |
| ● SR | _14 | 4,6 |
| ● OO | _5 | 4,3 |
| ● OS | _11 | 4,6 |

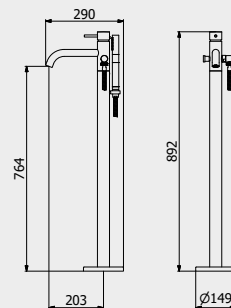

PORTATE | WATER FLOW | DÉBIT D'EAU

| | | |
|----------|--------|----------|
| 1 BAR | 2 BAR | 3 BAR |
| 11,2 l/m | 16 l/m | 19,5 l/m |

PACKAGING

| | | | |
|--|------------|--|---------|
| | L: 1100 mm | | 15,6 kg |
| | D: 395 mm | | |
| | H: 150 mm | | |

Built-in body to be purchased separately
AVAILABLE FROM JANUARY 2020Corpo incasso da acquistare separatamente
DISPONIBILE DA GENNAIO 2020Corps intégré à acheter séparément
DISPONIBLE À PARTIR DE JANVIER 2020

CODICE | CODE | CODE

INC399XXN_19

COEFFICIENT | COEFFICIENTE | COEFFICIENT

2,8

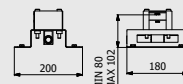

ARTICLE | ARTICOLO | ARTICLE

ID800



Industria thermostatic shower column with shower kit

Colonna doccia Industria termostatica con kit doccia

Industria colonne de douche thermostatique avec kit douche

CODE / COEFFICIENT | CODICE / COEFFICIENTE | CODE / COEFFICIENT

BODY | CORPO | CORPS

LEVER | LEVA | LEVIER



+



| | | |
|------|---------|------|
| ● CC | ID800CC | 30,8 |
| ● SS | ID800SS | 46,1 |
| ● ON | ID800ON | 30,8 |
| ● NP | ID800NP | 36,9 |
| ● CF | ID800CF | 46,1 |
| ● CS | ID800CS | 49,2 |
| ● II | ID800II | 46,1 |
| ● IS | ID800IS | 49,2 |
| ● RS | ID800RS | 46,1 |
| ● SR | ID800SR | 49,2 |
| ● OO | ID800OO | 46,1 |
| ● OS | ID800OS | 49,2 |



| | | |
|------|-----|-----|
| ● CC | _1 | 5,4 |
| ● SS | _2 | 8,1 |
| ● ON | _10 | 5,4 |
| ● NP | _13 | 6,5 |
| ● CF | _3 | 8,1 |
| ● CS | _4 | 8,6 |
| ● II | _8 | 8,1 |
| ● IS | _9 | 8,6 |
| ● RS | _7 | 8,1 |
| ● SR | _14 | 8,6 |
| ● OO | _5 | 8,1 |
| ● OS | _11 | 8,6 |

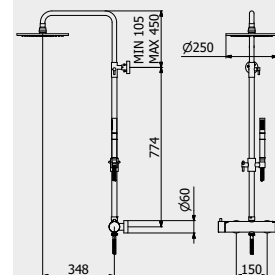

PORTATE | WATER FLOW | DÉBIT D'EAU

| | | |
|---------|----------|----------|
| 1 BAR | 2 BAR | 3 BAR |
| 7,8 l/m | 11,1 l/m | 12,5 l/m |

PACKAGING

| | | | |
|--|------------|--|--------|
| | L: 1020 mm | | 3,4 kg |
| | D: 490 mm | | |
| | H: 120 mm | | |



ARTICLE | ARTICOLO | ARTICLE

ID320



Wall mounted spout
Bocca d'erogazione a parete
Bec de remplissage mural

CODE / COEFFICIENT | CODICE / COEFFICIENTE | CODE / COEFFICIENT

BODY | CORPO | CORPS

LEVER | LEVA | LEVIER



| | | | | | | | |
|--|----|---------|-----|--|----|-----|-----|
| | CC | ID320CC | 2,3 | | CC | _1 | 0,5 |
| | SS | ID320SS | 3,5 | | SS | _2 | 0,8 |
| | ON | ID320ON | 2,3 | | ON | _10 | 0,5 |
| | NP | ID320NP | 2,8 | | NP | _13 | 0,6 |
| | CF | ID320CF | 3,5 | | CF | _3 | 0,8 |
| | CS | ID320CS | 3,7 | | CS | _4 | 0,8 |
| | II | ID320II | 3,5 | | II | _8 | 0,8 |
| | IS | ID320IS | 3,7 | | IS | _9 | 0,8 |
| | RS | ID320RS | 3,5 | | RS | _7 | 0,8 |
| | SR | ID320SR | 3,7 | | SR | _14 | 0,8 |
| | OO | ID320OO | 3,5 | | OO | _5 | 0,8 |
| | OS | ID320OS | 3,7 | | OS | _11 | 0,8 |

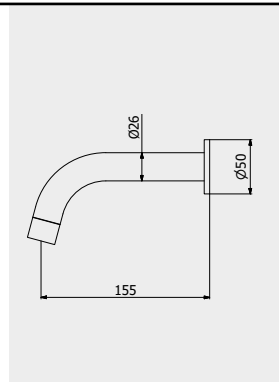

PORTATE | WATER FLOW | DÉBIT D'EAU

| | | |
|---------|-------|-------|
| 1 BAR | 2 BAR | 3 BAR |
| 6,5 l/m | 8 l/m | 8 l/m |

PACKAGING

| | | | |
|--|-----------|--|---------|
| | L: 150 mm | | 0,24 kg |
| | D: 190 mm | | |
| | H: 98 mm | | |

Industria

ARTICLE | ARTICOLO | ARTICLE

ID321



Short wall mounted spout
Bocca d'erogazione corta a parete
Bec de remplissage mural court

CODE / COEFFICIENT | CODICE / COEFFICIENTE | CODE / COEFFICIENT

BODY | CORPO | CORPS

LEVER | LEVA | LEVIER



| | | | | | | | |
|--|----|---------|-----|--|----|-----|-----|
| | CC | ID321CC | 2,5 | | CC | _1 | 0,5 |
| | SS | ID321SS | 3,7 | | SS | _2 | 0,8 |
| | ON | ID321ON | 2,5 | | ON | _10 | 0,5 |
| | NP | ID321NP | 2,9 | | NP | _13 | 0,6 |
| | CF | ID321CF | 3,7 | | CF | _3 | 0,8 |
| | CS | ID321CS | 3,9 | | CS | _4 | 0,8 |
| | II | ID321II | 3,7 | | II | _8 | 0,8 |
| | IS | ID321IS | 3,9 | | IS | _9 | 0,8 |
| | RS | ID321RS | 3,7 | | RS | _7 | 0,8 |
| | SR | ID321SR | 3,9 | | SR | _14 | 0,8 |
| | OO | ID321OO | 3,7 | | OO | _5 | 0,8 |
| | OS | ID321OS | 3,9 | | OS | _11 | 0,8 |

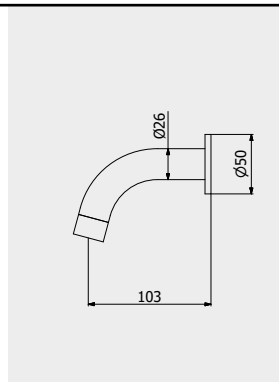

PORTATE | WATER FLOW | DÉBIT D'EAU

| | | |
|---------|-------|-------|
| 1 BAR | 2 BAR | 3 BAR |
| 6,5 l/m | 8 l/m | 8 l/m |

PACKAGING

| | | | |
|--|-----------|--|---------|
| | L: 150 mm | | 0,23 kg |
| | D: 190 mm | | |
| | H: 98 mm | | |

ARTICLE | ARTICOLO | ARTICLE

ID322



Long wall mounted spout
Bocca d'erogazione lunga a parete
Bec de remplissage mural long

CODE / COEFFICIENT | CODICE / COEFFICIENTE | CODE / COEFFICIENT

BODY | CORPO | CORPS

LEVER | LEVA | LEVIER



| | | | | | | | |
|--|----|----------|-----|--|----|-----|-----|
| | CC | ID322CC | 2,5 | | CC | _1 | 0,5 |
| | SS | ID322SS | 3,7 | | SS | _2 | 0,8 |
| | ON | ID322ON | 2,5 | | ON | _10 | 0,5 |
| | NP | ID322ONP | 2,9 | | NP | _13 | 0,6 |
| | CF | ID322CF | 3,7 | | CF | _3 | 0,8 |
| | CS | ID322CS | 3,9 | | CS | _4 | 0,8 |
| | II | ID322II | 3,7 | | II | _8 | 0,8 |
| | IS | ID322IS | 3,9 | | IS | _9 | 0,8 |
| | RS | ID322RS | 3,7 | | RS | _7 | 0,8 |
| | SR | ID322SR | 3,9 | | SR | _14 | 0,8 |
| | OO | ID322OO | 3,7 | | OO | _5 | 0,8 |
| | OS | ID322OS | 3,9 | | OS | _11 | 0,8 |

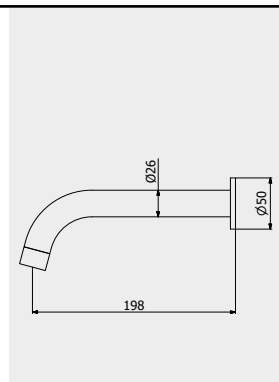

PORTATE | WATER FLOW | DÉBIT D'EAU

| | | |
|---------|-------|-------|
| 1 BAR | 2 BAR | 3 BAR |
| 6,5 l/m | 8 l/m | 8 l/m |

PACKAGING

| | | | |
|--|-----------|--|---------|
| | L: 150 mm | | 0,25 kg |
| | D: 190 mm | | |
| | H: 98 mm | | |

ARTICLE | ARTICOLO | ARTICLE

B2022



Duplex

Duplex

Duplex

CODE / COEFFICIENT | CODICE / COEFFICIENTE | CODE / COEFFICIENT

| | | |
|------|---------|------|
| ● CC | B2022CC | 6,3 |
| ● SS | B2022SS | 7,9 |
| ● ON | B2022ON | 6,3 |
| ● NP | B2022NP | 7,9 |
| ● CF | B2022CF | 9,5 |
| ● CS | B2022CS | 10,1 |
| ● II | B2022II | 9,5 |
| ● IS | B2022IS | 10,1 |
| ● RS | B2022RS | 9,5 |
| ● SR | B2022SR | 10,1 |
| ● OO | B2022OO | 9,5 |
| ● OS | B2022OS | 10,1 |

PACKAGING

 L: 340 mm
D: 180 mm
H: 70 mm

1,0 kg

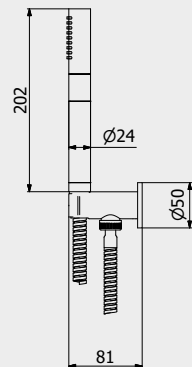

ARTICLE | ARTICOLO | ARTICLE

ID706



Exposed parts for bidet spray complete with mixer

Set di parti esterne per Idroscopino igienico con miscelatore

Partie extérieure pour douchette hygiénique avec mitigeur

CODE / COEFFICIENT | CODICE / COEFFICIENTE | CODE / COEFFICIENT

BODY | CORPO | CORPS

LEVER | LEVA | LEVIER

| | | |
|------|---------|-----|
| ● CC | ID706CC | 6,1 |
| ● SS | ID706SS | 9,2 |
| ● ON | ID706ON | 6,1 |
| ● NP | ID706NP | 7,3 |
| ● CF | ID706CF | 9,2 |
| ● CS | ID706CS | 9,8 |
| ● II | ID706II | 9,2 |
| ● IS | ID706IS | 9,8 |
| ● RS | ID706RS | 9,2 |
| ● SR | ID706SR | 9,8 |
| ● OO | ID706OO | 9,2 |
| ● OS | ID706OS | 9,8 |
| ● CC | _1 | 3,8 |
| ● SS | _2 | 5,7 |
| ● ON | _10 | 3,8 |
| ● NP | _13 | 4,6 |
| ● CF | _3 | 5,7 |
| ● CS | _4 | 6,1 |
| ● II | _8 | 5,7 |
| ● IS | _9 | 6,1 |
| ● RS | _7 | 5,7 |
| ● SR | _14 | 6,1 |
| ● OO | _5 | 5,7 |
| ● OS | _11 | 6,1 |

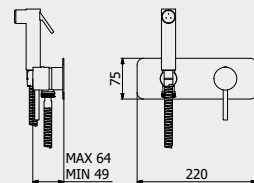

PORTATE | WATER FLOW | DÉBIT D'EAU

| | | |
|---------|---------|-------|
| 1 BAR | 2 BAR | 3 BAR |
| 2,3 l/m | 3,2 l/m | 4 l/m |

PACKAGING

 L: 370 mm
D: 270 mm
H: 80 mm

3,1 kg

Built-in body to be purchased separately

Corpo incasso da acquistare separatamente

Corps intégré à acheter séparément



CODICE | CODE | CODE

INC206XXXN_19

COEFFICIENT | COEFFICIENTE | COEFFICIENT

2,9



ARTICLE | ARTICOLO | ARTICLE

ID370



Single Lever kitchen mixer

Miscelatore lavello monoforo

Évier de cuisine

CODE / COEFFICIENT | CODICE / COEFFICIENTE | CODE / COEFFICIENT

BODY | CORPO | CORPS

LEVER | LEVA | LEVIER

| | | |
|------|----------|------|
| ● CC | ID370CC | 9,3 |
| ● SS | ID370SS | 14,0 |
| ● ON | ID370ON | 9,3 |
| ● NP | ID370ONP | 11,2 |
| ● CF | ID370CF | 14,0 |
| ● CS | ID370CS | 14,9 |
| ● II | ID370II | 14,0 |
| ● IS | ID370IS | 14,9 |
| ● RS | ID370RS | 14,0 |
| ● SR | ID370SR | 14,9 |
| ● OO | ID370OO | 14,0 |
| ● OS | ID370OS | 14,9 |
| ● CC | _1 | 1,1 |
| ● SS | _2 | 1,7 |
| ● ON | _10 | 1,1 |
| ● NP | _13 | 1,4 |
| ● CF | _3 | 1,7 |
| ● CS | _4 | 1,8 |
| ● II | _8 | 1,7 |
| ● IS | _9 | 1,8 |
| ● RS | _7 | 1,7 |
| ● SR | _14 | 1,8 |
| ● OO | _5 | 1,7 |
| ● OS | _11 | 1,8 |

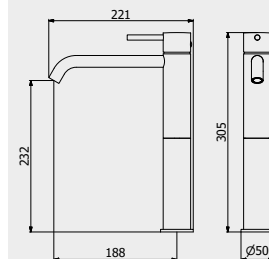

PORTATE | WATER FLOW | DÉBIT D'EAU

| | | |
|---------|---------|---------|
| 1 BAR | 2 BAR | 3 BAR |
| 5,5 l/m | 7,5 l/m | 9,1 l/m |

PACKAGING

 L: 455 mm
D: 310 mm
H: 75 mm

2,7 kg



OFFICINA / ACCESSORIES COLLECTION

Industria



ARTICLE | ARTICOLO | ARTICLE

OF006



PACKAGING

L: 330 mm
D: 90 mm
H: 40 mm

0,15 kg

Towel holder
Porta salvietta
Porte-serviette

CODE / COEFFICIENT | CODICE / COEFFICIENTE | CODE / COEFFICIENT

| | | |
|----|---------|-----|
| CC | OF006CC | 2,4 |
| SS | OF006SS | 3,0 |
| ON | OF006ON | 2,4 |
| BO | OF006BO | 2,9 |
| NP | OF006NP | 2,9 |
| CF | OF006CF | 3,6 |
| CS | OF006CS | 3,8 |
| II | OF006II | 3,6 |
| IS | OF006IS | 3,8 |
| RS | OF006RS | 3,6 |
| SR | OF006SR | 3,8 |
| OO | OF006OO | 3,6 |
| OS | OF006OS | 3,8 |

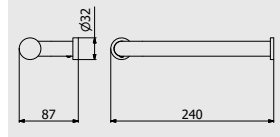

ARTICLE | ARTICOLO | ARTICLE

OF011



PACKAGING

L: 410 mm
D: 195 mm
H: 100 mm

0,3 kg

Toilet paper holder
Porta rotolo
Porte rouleaux de toilette

CODE / COEFFICIENT | CODICE / COEFFICIENTE | CODE / COEFFICIENT

| | | |
|----|---------|-----|
| CC | OF011CC | 2,1 |
| SS | OF011SS | 2,6 |
| ON | OF011ON | 2,1 |
| BO | OF011BO | 2,6 |
| NP | OF011NP | 2,6 |
| CF | OF011CF | 3,2 |
| CS | OF011CS | 3,4 |
| II | OF011II | 3,2 |
| IS | OF011IS | 3,4 |
| RS | OF011RS | 3,2 |
| SR | OF011SR | 3,4 |
| OO | OF011OO | 3,2 |
| OS | OF011OS | 3,4 |

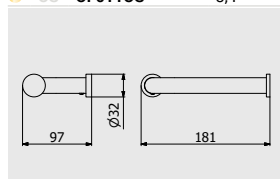

ARTICLE | ARTICOLO | ARTICLE

OF012



PACKAGING

L: 410 mm
D: 195 mm
H: 100 mm

0,3 kg

Toilet brush holder
Porta scopino da terra
Porte balayette au sol

CODE / COEFFICIENT | CODICE / COEFFICIENTE | CODE / COEFFICIENT

| | | |
|----|---------|------|
| CC | OF012CC | 6,9 |
| SS | OF012SS | 8,6 |
| ON | OF012ON | 6,9 |
| BO | OF012BO | 8,6 |
| NP | OF012NP | 8,6 |
| CF | OF012CF | 10,4 |
| CS | OF012CS | 11,0 |
| II | OF012II | 10,4 |
| IS | OF012IS | 11,0 |
| RS | OF012RS | 10,4 |
| SR | OF012SR | 11,0 |
| OO | OF012OO | 10,4 |
| OS | OF012OS | 11,0 |

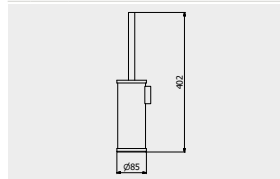

ARTICLE | ARTICOLO | ARTICLE

OF008



PACKAGING

L: 60 mm
D: 60 mm
H: 60 mm

0,08 kg

Robe Hook
Appendino a parete
Cintre

CODE / COEFFICIENT | CODICE / COEFFICIENTE | CODE / COEFFICIENT

| | | |
|----|---------|-----|
| CC | OF008CC | 1,0 |
| SS | OF008SS | 1,3 |
| ON | OF008ON | 1,0 |
| BO | OF008BO | 1,3 |
| NP | OF008NP | 1,3 |
| CF | OF008CF | 1,5 |
| CS | OF008CS | 1,6 |
| II | OF008II | 1,5 |
| IS | OF008IS | 1,6 |
| RS | OF008RS | 1,5 |
| SR | OF008SR | 1,6 |
| OO | OF008OO | 1,5 |
| OS | OF008OS | 1,6 |

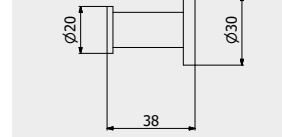

ARTICLE | ARTICOLO | ARTICLE

OF014



PACKAGING

L: 500 mm
D: 100 mm
H: 45 mm

0,4 kg

Towel holder
Porta salvietta
Porte-serviette

CODE / COEFFICIENT | CODICE / COEFFICIENTE | CODE / COEFFICIENT

| | | |
|----|---------|-----|
| CC | OF014CC | 3,7 |
| SS | OF014SS | 4,6 |
| ON | OF014ON | 3,7 |
| BO | OF014BO | 4,6 |
| NP | OF014NP | 4,6 |
| CF | OF014CF | 5,6 |
| CS | OF014CS | 5,9 |
| II | OF014II | 5,6 |
| IS | OF014IS | 5,9 |
| RS | OF014RS | 5,6 |
| SR | OF014SR | 5,9 |
| OO | OF014OO | 5,6 |
| OS | OF014OS | 5,9 |

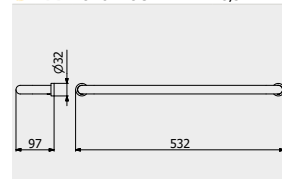

ARTICLE | ARTICOLO | ARTICLE

OF002



PACKAGING

L: 170 mm
D: 60 mm
H: 80 mm

0,6 kg

Soap dispenser holder
Porta dispenser sapone liquido
Porte distributeur de savon

CODE / COEFFICIENT | CODICE / COEFFICIENTE | CODE / COEFFICIENT

| | | |
|----|---------|-----|
| CC | OF002CC | 3,7 |
| SS | OF002SS | 4,6 |
| ON | OF002ON | 3,7 |
| BO | OF002BO | 4,6 |
| NP | OF002NP | 4,6 |
| CF | OF002CF | 5,6 |
| CS | OF002CS | 5,9 |
| II | OF002II | 5,6 |
| IS | OF002IS | 5,9 |
| RS | OF002RS | 5,6 |
| SR | OF002SR | 5,9 |
| OO | OF002OO | 5,6 |
| OS | OF002OS | 5,9 |

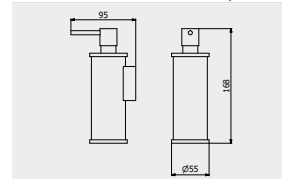



TAAAC

The round shape of square.

La forma tonda del quadrato.
La forme ronde du carré.

"Taaac, and it's already done!" A versatile project designed to simplify forms and functions, TAAAC draws its inspiration from the immediate and friendly design of the most widespread technological appliances, from their hybrid and variable forms, never completely round or square. The collection also proposes to minimize the faucet structure, in order to provide only what is really essential. Thus TAAAC becomes a symbol of practical immediacy and aesthetical hybridity, through a highly recognisable look.

"Taaac, ed è subito fatto!". Progetto versatile, volto a semplificare forme e funzioni, TAAAC prende ispirazione dal design immediato e affabile dei più diffusi apparecchi tecnologici, ispirandosi alle loro forme ibride e cangianti, mai completamente tonde né squadrate. La serie propone inoltre di ridurre al minimo le strutture del rubinetto, per fornire solo ciò di cui si ha veramente bisogno. TAAAC si fa così sinonimo di immediatezza funzionale e commistione di forme dall'alta riconoscibilità estetica.

"Taaac, et c'est déjà fait!" Projet éclectique visant à simplifier les formes et les fonctions, TAAAC s'inspire du design immédiat et aimable des appareils technologiques les plus connus, inspiré par leurs formes hybrides et changeantes, jamais complètement rondes ni carrées. La collection propose également de minimiser la structure du robinet pour ne pourvoir que ce qui est vraiment nécessaire. Ainsi, TAAAC devient un produit synonyme d'immédiateté fonctionnelle et de mélange de formes, à la forte identité esthétique.



CRYSTAL CLEAR
WATER



DOUBLE LEVER



LEAD FREE



ZINC FREE





It's a collection of mixers with the idea of expressing a new universal and shared language in the bathroom context, simplifying shapes and interaction. It just makes things easy from many perspectives.

Una serie di rubinetti sintesi di un concept che ha come obiettivo stabilire un nuovo linguaggio universale e condiviso nell'ambiente bagno, semplificando forme, usi e funzioni.

C'est une collection de mitigeurs qui exprime un nouveau langage universel et partagé dans la salle de bain, en simplifiant forme et interaction. Elle facilite les tâches de nombreux points de vue.

“ **TAAAC expresses the idea of simplification, both in shape and interaction within the bathroom context. The idea with TAAAC was to shape a product of universal and shared language fitting any room and style.**

TAAAC è sintesi di un concept che riduce al minimo forme, usi e funzioni nel mondo del bagno. L'obiettivo è dar forma a un prodotto dal linguaggio universale e condiviso, adatto a ogni ambiente e stile.

TAAAC se fait synthèse d'un concept visant à minimiser les formes, les usages et les fonctions dans le monde de la salle de bain. L'objectif est celui de concevoir un produit avec un langage universel et partagé, indiqué pour tous les espaces et les styles. ”

Federico Castelli design for TAAAC

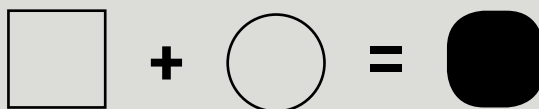

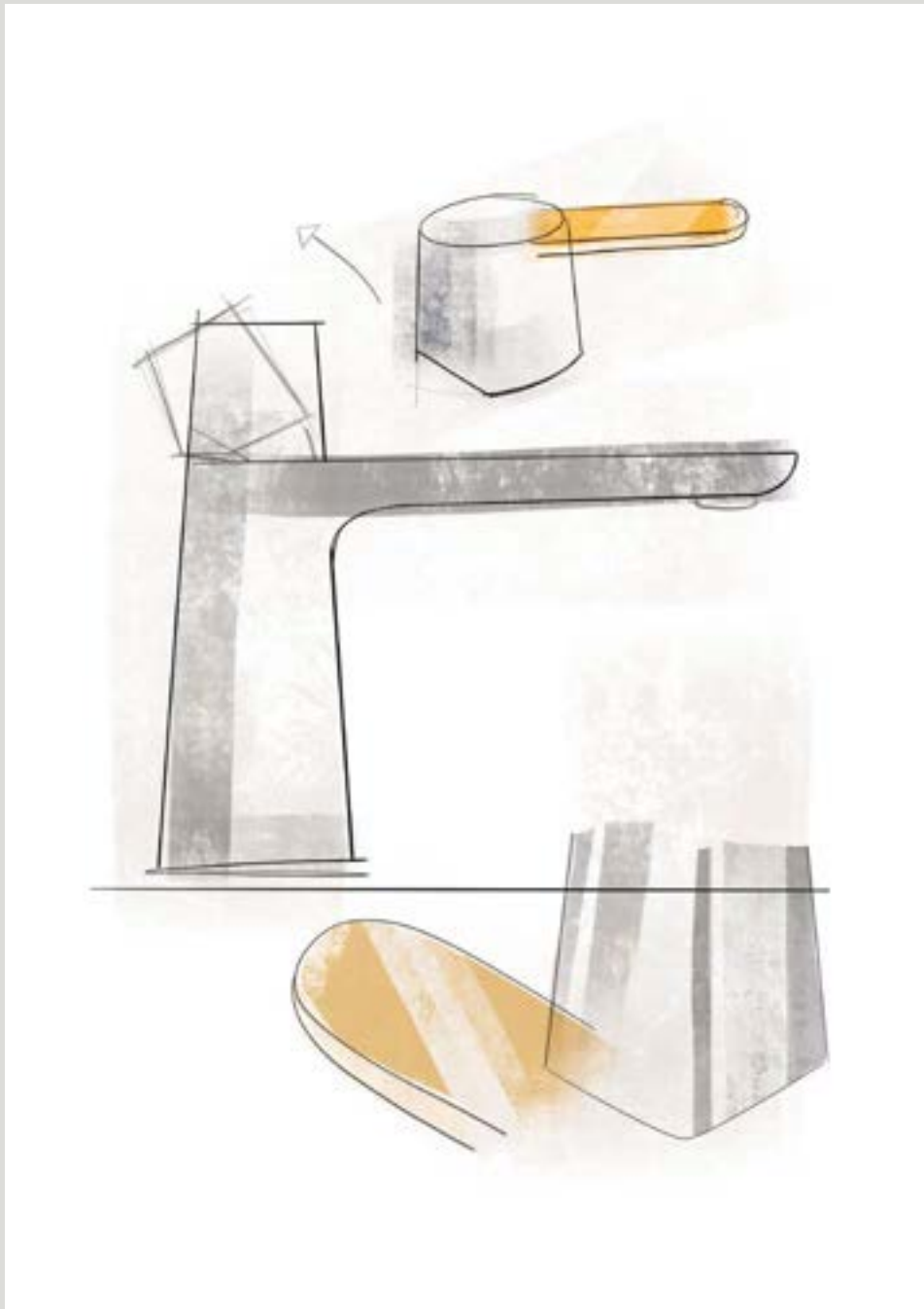



↑ AA200NP
Monohole washbasin mixer
Miscelatore lavabo monoforo
Mitigeur lavabo

→ AA202CC
Tall monohole washbasin mixer
Miscelatore lavabo monoforo alto
Mitigeur lavabo haut









↑ AA392NP
Three holes washbasin set with low spout
← Lavabo tre fori a bocca bassa
← Lavabo trois trous bec bas





- ← AA202CC
Tall monohole washbasin mixer
Miscelatore lavabo monoforo alto
Mitigeur lavabo haut
- ↗ AA220CC
Monohole bidet mixer
Miscelatore bidet monoforo
Mitigeur bidet
- AA206CC
Wall mounted washbasin mixer
Miscelatore lavabo due fori a parete
Mitigeur lavabo mural



← AA314CC
Three ways wall shower mixer complete with shower kit
 Miscelatore doccia a parete con deviatore tre vie e doccino integrato
 Mitigeur douche mural trois voies avec inverseur et douchette encastrée

↙ AA300CC
One way wall shower mixer
 Miscelatore doccia a parete una via
 Mitigeur douche mural une voie

→ AA399CC
Free-standing bath filler with shower kit
 Bordo vasca da terra con kit doccia
 Bain douche complet alimentation au sol

A Diverter

Deviatore

Déviateur

B Mixer

Miscelatore

Mitigeur







↑ AA740CC
Two holes deck mounted bath filler mixer
with shower kit
Miscelatore Bordo vasca da appoggio due fori
con doccia
Mitigeur Bain/douche 2 trous avec douchette

ARTICLE | ARTICOLO | ARTICLE

AA200



Monohole washbasin mixer complete with drain
 Miscelatore lavabo monoforo completo di scarico automatico
 Mitigeur Lavabo complet avec bonde automatique

| CODE / COEFFICIENT | CODICE / COEFFICIENTE | |
|--------------------|-----------------------|------|
| CC | AA200CC | 6,6 |
| SS | AA200SS | 8,3 |
| BO | AA200BO | 7,9 |
| NP | AA200NP | 7,9 |
| OS | AA200OS | 10,6 |

PACKAGING

L: 340 mm
 D: 180 mm
 H: 70 mm
 2,0 kg

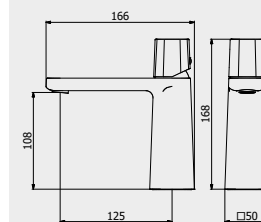

PORTATE | WATER FLOW | DÉBIT D'EAU

| 1 BAR | 2 BAR | 3 BAR |
|---------|-------|-------|
| 4,5 l/m | 5 l/m | 5 l/m |

Taaac

ARTICLE | ARTICOLO | ARTICLE

AA202



Tall monohole washbasin mixer complete with drain
 Miscelatore lavabo monoforo alto completo di scarico automatico
 Mitigeur lavabo haut complet avec bonde automatique

| CODE / COEFFICIENT | CODICE / COEFFICIENTE | |
|--------------------|-----------------------|------|
| CC | AA202CC | 10,7 |
| SS | AA202SS | 13,4 |
| BO | AA202BO | 12,8 |
| NP | AA202NP | 12,8 |
| OS | AA202OS | 17,1 |

PACKAGING

L: 340 mm
 D: 180 mm
 H: 70 mm
 3,0 kg

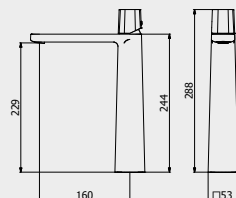

PORTATE | WATER FLOW | DÉBIT D'EAU

| 1 BAR | 2 BAR | 3 BAR |
|---------|-------|-------|
| 4,5 l/m | 5 l/m | 5 l/m |

ARTICLE | ARTICOLO | ARTICLE

AA392



Three holes washbasin set with low spout
 Lavabo tre fori a bocca bassa completo di scarico automatico
 Lavabo trois trous bec bas

| CODE / COEFFICIENT | CODICE / COEFFICIENTE | |
|--------------------|-----------------------|------|
| CC | AA392CC | 12,2 |
| SS | AA392SS | 15,3 |
| BO | AA392BO | 14,6 |
| NP | AA392NP | 14,6 |
| OS | AA392OS | 19,5 |

PACKAGING

L: 340 mm
 D: 180 mm
 H: 70 mm
 3,5 kg

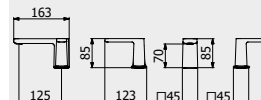

PORTATE | WATER FLOW | DÉBIT D'EAU

| 1 BAR | 2 BAR | 3 BAR |
|---------|-------|-------|
| 4,5 l/m | 5 l/m | 5 l/m |

ARTICLE | ARTICOLO | ARTICLE

AA206



Wall mounted washbasin mixer complete with drain

Miscelatore lavabo due fori a parete completo di scarico automatico

Mitigeur lavabo mural complet avec bonde automatique

| CODE / COEFFICIENT | CODICE / COEFFICIENTE | CODE / COEFFICIENT |
|--------------------|-----------------------|--------------------|
| CC | EAA206CC | 9,5 |
| SS | EAA206SS | 11,9 |
| BO | EAA206BO | 11,4 |
| NP | EAA206NP | 11,4 |
| OS | EAA206OS | 15,2 |

PACKAGING

L: 265 mm
D: 260 mm
H: 70 mm

1,9 kg

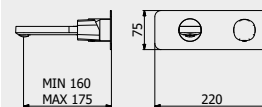

PORTATE | WATER FLOW | DÉBIT D'EAU

| | | |
|---------|-------|-------|
| 1 BAR | 2 BAR | 3 BAR |
| 4,5 l/m | 5 l/m | 5 l/m |

Built-in body to be purchased separately

Corpo incasso da acquistare separatamente

Corps intégré à acheter séparément



CODICE | CODE | CODE

INC206XXXN_19

COEFFICIENT | COEFFICIENTE | COEFFICIENT

2,9



ARTICLE | ARTICOLO | ARTICLE

AA220



Monohole bidet mixer complete with drain

Miscelatore bidet monoforo completo di scarico automatico

Mitigeur bidet complet avec bonde automatique

| CODE / COEFFICIENT | CODICE / COEFFICIENTE | CODE / COEFFICIENT |
|--------------------|-----------------------|--------------------|
| CC | AA220CC | 6,6 |
| SS | AA220SS | 8,3 |
| BO | AA220BO | 7,9 |
| NP | AA220NP | 7,9 |
| OS | AA220OS | 10,6 |

PACKAGING

L: 370 mm
D: 270 mm
H: 80 mm

1,9 kg

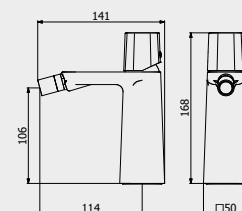

PORTATE | WATER FLOW | DÉBIT D'EAU

| | | |
|---------|-------|-------|
| 1 BAR | 2 BAR | 3 BAR |
| 4,5 l/m | 5 l/m | 5 l/m |

ARTICLE | ARTICOLO | ARTICLE

AA300



Exposed parts for manual wall mixer

Set di parti esterne per miscelatore a parete ad una via

Partie extérieure pour mitigeur encastré à une voie

| CODE / COEFFICIENT | CODICE / COEFFICIENTE | CODE / COEFFICIENT |
|--------------------|-----------------------|--------------------|
| CC | EAA300CC | 4,1 |
| SS | EAA300SS | 5,1 |
| BO | EAA300BO | 4,9 |
| NP | EAA300NP | 4,9 |
| OS | EAA300OS | 6,6 |

PACKAGING

L: 150 mm
D: 190 mm
H: 98 mm

1,9 kg

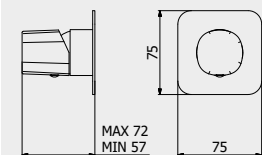

PORTATE | WATER FLOW | DÉBIT D'EAU

| | | |
|----------|----------|--------|
| 1 BAR | 2 BAR | 3 BAR |
| 11,5 l/m | 16,3 l/m | 20 l/m |

Built-in body to be purchased separately

Corpo incasso da acquistare separatamente

Corps intégré à acheter séparément



CODICE | CODE | CODE

INC300XXXN_19

COEFFICIENT | COEFFICIENTE | COEFFICIENT

1,8



ARTICLE | ARTICOLO | ARTICLE

AA310



Exposed parts for manual wall mixer with two ways diverter
 Miscelatore doccia a parete con deviatore due vie
 Mitigeur douche mural deux voies avec inverseur

| CODE / COEFFICIENT | CODICE / COEFFICIENTE | |
|--------------------|-----------------------|-----|
| CC | EAA310CC | 6,1 |
| SS | EAA310SS | 7,6 |
| BO | EAA310BO | 7,3 |
| NP | EAA310NP | 7,3 |
| OS | EAA310OS | 9,8 |

PACKAGING

L: 150 mm
 D: 190 mm
 H: 98 mm
 1,9 kg

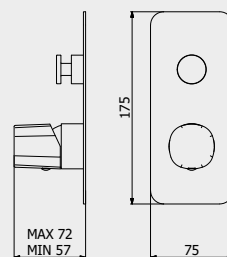

PORTATE | WATER FLOW | DÉBIT D'EAU

| 1 BAR | 2 BAR | 3 BAR |
|----------|----------|----------|
| 11,6 l/m | 16,3 l/m | 20,1 l/m |

Taaac

Built-in body to be purchased separately

Corpo incasso da acquistare separatamente

Corps intégré à acheter séparément



CODICE | CODE | CODE

INC310XXXN_19

COEFFICIENTE | COEFFICIENT | COEFFICIENT

3,3

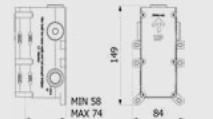

ARTICLE | ARTICOLO | ARTICLE

AA312



Exposed parts for manual wall mixer with three ways diverter
 Set di parti esterne per miscelatore a parete a tre vie
 Mitigeur douche mural trois voies avec inverseur

| CODE / COEFFICIENT | CODICE / COEFFICIENTE | |
|--------------------|-----------------------|------|
| CC | EAA312CC | 7,4 |
| SS | EAA312SS | 9,3 |
| BO | EAA312BO | 8,9 |
| NP | EAA312NP | 8,9 |
| OS | EAA312OS | 11,8 |

PACKAGING

L: 150 mm
 D: 190 mm
 H: 98 mm
 1,9 kg

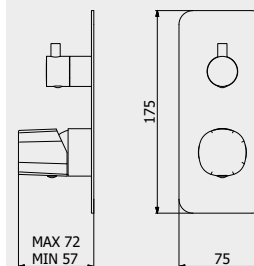

PORTATE | WATER FLOW | DÉBIT D'EAU

| 1 BAR | 2 BAR | 3 BAR |
|---------|----------|----------|
| 8,3 l/m | 11,7 l/m | 24,3 l/m |

Built-in body to be purchased separately

Corpo incasso da acquistare separatamente

Corps intégré à acheter séparément



CODICE | CODE | CODE

INC312XXXN_19

COEFFICIENTE | COEFFICIENT | COEFFICIENT

3,3

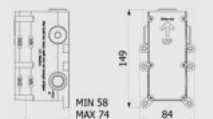

ARTICLE | ARTICOLO | ARTICLE

AA313



Two ways wall shower mixer complete with shower kit
 Miscelatore doccia a parete con deviatore due vie e doccino integrato
 Mitigeur douche mural 2 voies avec inverseur et douchette encastrée

| CODE / COEFFICIENT | CODICE / COEFFICIENTE | |
|--------------------|-----------------------|------|
| CC | EAA313CC | 10,4 |
| SS | EAA313SS | 13,0 |
| BO | EAA313BO | 12,5 |
| NP | EAA313NP | 12,5 |
| OS | EAA313OS | 16,6 |

PACKAGING

L: 370 mm
 D: 270 mm
 H: 80 mm
 2,1 kg

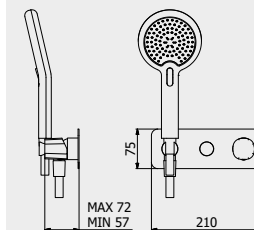

PORTATE | WATER FLOW | DÉBIT D'EAU

| 1 BAR | 2 BAR | 3 BAR |
|--------|----------|----------|
| 10 l/m | 14,1 l/m | 17,2 l/m |

Built-in body to be purchased separately

Corpo incasso da acquistare separatamente

Corps intégré à acheter séparément



CODICE | CODE | CODE

INC313XXXN_19

COEFFICIENTE | COEFFICIENT | COEFFICIENT

3,6



ARTICLE | ARTICOLO | ARTICLE

AA314



Three ways wall shower mixer complete with shower kit
Miscelatore doccia a parete con deviatore tre vie e doccino integrato
Mitigeur douche mural 3 voies avec inverseur et douchette encastrée

| CODE / COEFFICIENT | CODICE / COEFFICIENTE | CODE / COEFFICIENT |
|--------------------|-----------------------|--------------------|
| CC | EAA314CC | 11,4 |
| SS | EAA314SS | 14,3 |
| BO | EAA314BO | 13,7 |
| NP | EAA314NP | 13,7 |
| OS | EAA314OS | 18,2 |

PACKAGING

| |
|-----------|
| L: 370 mm |
| D: 270 mm |
| H: 80 mm |
| 2,1 kg |

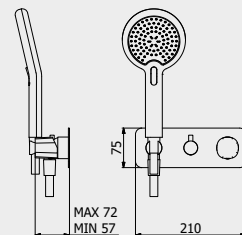

PORTATE | WATER FLOW | DÉBIT D'EAU

| | | |
|---------|---------|-------|
| 1 BAR | 2 BAR | 3 BAR |
| 2,3 l/m | 3,2 l/m | 4 l/m |

Built-in body to be purchased separately

Corpo incasso da acquistare separatamente

Corps intégré à acheter séparément



CODICE | CODE | CODE

INC314XXXN_19

COEFFICIENTE | COEFFICIENT | COEFFICIENT

3,7



ARTICLE | ARTICOLO | ARTICLE

AA399



Free-standing bath filler with shower kit

Bordo vasca da terra con kit doccia

Bain douche complet alimentation au sol

| CODE / COEFFICIENT | CODICE / COEFFICIENTE | CODE / COEFFICIENT |
|--------------------|-----------------------|--------------------|
| CC | EAA399CC | 39,7 |
| SS | EAA399SS | 49,6 |
| BO | EAA399BO | 47,6 |
| NP | EAA399NP | 47,6 |
| OS | EAA399OS | 63,5 |

PACKAGING

| |
|------------|
| L: 1160 mm |
| D: 360 mm |
| H: 180 mm |
| 14,7 kg |

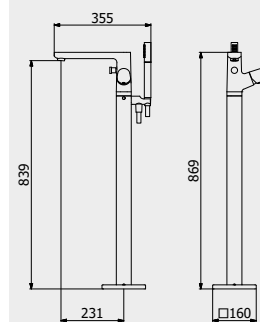

PORTATE | WATER FLOW | DÉBIT D'EAU

| | | |
|----------|----------|----------|
| 1 BAR | 2 BAR | 3 BAR |
| 12,6 l/m | 18,1 l/m | 22,5 l/m |

Built-in body to be purchased separately
AVAILABLE FROM JANUARY 2020

Corpo incasso da acquistare separatamente
DISPONIBILE DA GENNAIO 2020

Corps intégré à acheter séparément
DISPONIBLE À PARTIR DE JANVIER 2020



CODICE | CODE | CODE

INC399XXXN_19

COEFFICIENTE | COEFFICIENT | COEFFICIENT

2,8

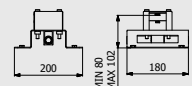

ARTICLE | ARTICOLO | ARTICLE

AA706



Exposed parts for bidet spray complete with mixer

Set di parti esterne per Idroscopino igienico con miscelatore

Partie extérieure pour douchette hygiénique avec mitigeur

| CODE / COEFFICIENT | CODICE / COEFFICIENTE | CODE / COEFFICIENT |
|--------------------|-----------------------|--------------------|
| CC | EAA706CC | 9,8 |
| SS | EAA706SS | 12,3 |
| BO | EAA706BO | 11,8 |
| NP | EAA706NP | 11,8 |
| OS | EAA706OS | 15,7 |

PACKAGING

| |
|-----------|
| L: 370 mm |
| D: 270 mm |
| H: 80 mm |
| 3,1 kg |

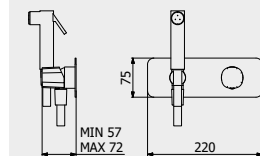

PORTATE | WATER FLOW | DÉBIT D'EAU

| | | |
|---------|---------|-------|
| 1 BAR | 2 BAR | 3 BAR |
| 2,3 l/m | 3,2 l/m | 4 l/m |

Built-in body to be purchased separately

Corpo incasso da acquistare separatamente

Corps intégré à acheter séparément



CODICE | CODE | CODE

INC206XXXN_19

COEFFICIENTE | COEFFICIENT | COEFFICIENT

2,9



ARTICLE | ARTICOLO | ARTICLE

AA740



Two holes deck mounted bath filler mixer with shower kit
 Miscelatore bordo vasca da appoggio due fori con doccino
 Mitigeur bain/douche deux trous avec douchette

| CODE / COEFFICIENT | CODICE / COEFFICIENTE | |
|--------------------|-----------------------|------|
| CC | AA740CC | 18,7 |
| SS | AA740SS | 23,4 |
| BO | AA740BO | 22,4 |
| NP | AA740NP | 22,4 |
| OS | AA740OS | 29,9 |

PACKAGING

| |
|-----------|
| L: 360 mm |
| D: 220 mm |
| H: 150 mm |
| 1,5 kg |

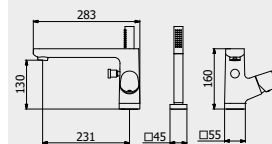

Taaac

PORTATE | WATER FLOW | DÉBIT D'EAU

| | | |
|----------|----------|----------|
| 1 BAR | 2 BAR | 3 BAR |
| 15,5 l/m | 21,4 l/m | 26,8 l/m |

ARTICLE | ARTICOLO | ARTICLE

AA320



Wall mounted spout
 Bocca d'erogazione a parete
 Bec de remplissage mural

| CODE / COEFFICIENT | CODICE / COEFFICIENTE | |
|--------------------|-----------------------|-----|
| CC | AA320CC | 4,0 |
| SS | AA320SS | 5,0 |
| BO | AA320BO | 4,8 |
| NP | AA320NP | 4,8 |
| OS | AA320OS | 6,4 |

PACKAGING

| |
|-----------|
| L: 150 mm |
| D: 190 mm |
| H: 98 mm |
| 1,1 kg |

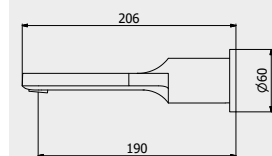

PORTATE | WATER FLOW | DÉBIT D'EAU

| | | |
|---------|-------|-------|
| 1 BAR | 2 BAR | 3 BAR |
| 4,5 l/m | 5 l/m | 5 l/m |

ARTICLE | ARTICOLO | ARTICLE

AA323



Wall mounted spout with diverter
 Bocca a parete con deviatore integrato e attacco per flessibile doccia
 Bec Mural avec déviateur, mitigeur, douchette et flexible

| CODE / COEFFICIENT | CODICE / COEFFICIENTE | |
|--------------------|-----------------------|-----|
| CC | AA323CC | 5,6 |
| SS | AA323SS | 7,0 |
| BO | AA323BO | 6,7 |
| NP | AA323NP | 6,7 |
| OS | AA323OS | 9,0 |

PACKAGING

| |
|-----------|
| L: 150 mm |
| D: 190 mm |
| H: 98 mm |
| 1,1 kg |

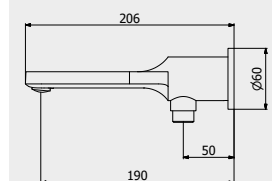

PORTATE | WATER FLOW | DÉBIT D'EAU

| | | |
|----------|----------|----------|
| 1 BAR | 2 BAR | 3 BAR |
| 29,2 l/m | 41,3 l/m | 50,6 l/m |

ARTICLE | ARTICOLO | ARTICLE

AA024



Duplex TAAAC
 Duplex TAAAC
 Duplex TAAAC

| CODE / COEFFICIENT | CODICE / COEFFICIENTE | |
|--------------------|-----------------------|-----|
| CC | AA024CC | 3,5 |
| SS | AA024SS | 4,4 |
| BO | AA024BO | 4,4 |
| NP | AA024NP | 4,4 |

PACKAGING

| |
|-----------|
| L: 265 mm |
| D: 260 mm |
| H: 70 mm |
| 1,4 kg |

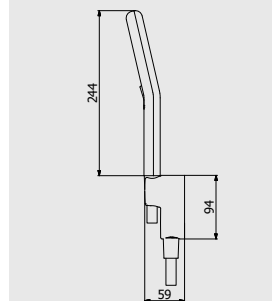

PORTATE | WATER FLOW | DÉBIT D'EAU

| | | |
|---------|---------|---------|
| 1 BAR | 2 BAR | 3 BAR |
| 5,3 l/m | 7,6 l/m | 9,4 l/m |

TAAAC / ACCESSORIES COLLECTION

ARTICLE | ARTICOLO | ARTICLE

AA001



Soap-holder

Porta sapone
Porte de savonCODE / COEFFICIENT | CODICE /
COEFFICIENTE | CODE / COEFFICIENT

| | | |
|----|---------|-----|
| CC | AA001CC | 1,1 |
| SS | AA001SS | 1,4 |

PACKAGING

| | | | |
|--|-----------|--|--------|
| | L: 130 mm | | 0,2 kg |
| | D: 90 mm | | |
| | H: 20 mm | | |

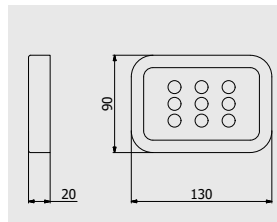

ARTICLE | ARTICOLO | ARTICLE

AA002



Soap dispenser

Dispenser sapone liquido
Distributeur de savonCODE / COEFFICIENT | CODICE /
COEFFICIENTE | CODE / COEFFICIENT

| | | |
|----|---------|-----|
| CC | AA002CC | 2,4 |
| SS | AA002SS | 3,0 |

PACKAGING

| | | | |
|--|-----------|--|--------|
| | L: 100 mm | | 0,5 kg |
| | D: 72 mm | | |
| | H: 182 mm | | |

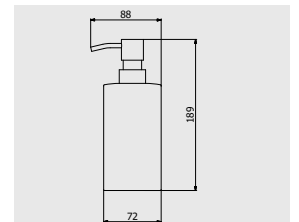

ARTICLE | ARTICOLO | ARTICLE

AA003



Toothbrush holder

Bicchiere porta spazzolino
Porte-verreCODE / COEFFICIENT | CODICE /
COEFFICIENTE | CODE / COEFFICIENT

| | | |
|----|---------|-----|
| CC | AA003CC | 1,2 |
| SS | AA003SS | 1,5 |

PACKAGING

| | | | |
|--|-----------|--|--------|
| | L: 72 mm | | 0,3 kg |
| | D: 72 mm | | |
| | H: 100 mm | | |

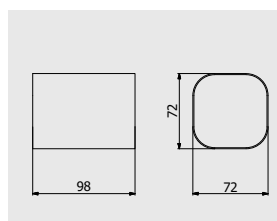

ARTICLE | ARTICOLO | ARTICLE

AA004



Towel holder

Porta salvietta
Porte-servietteCODE / COEFFICIENT | CODICE /
COEFFICIENTE | CODE / COEFFICIENT

| | | |
|----|---------|-----|
| CC | AA004CC | 2,7 |
| SS | AA004SS | 3,4 |

PACKAGING

| | | | |
|--|-----------|--|--------|
| | L: 600 mm | | 0,5 kg |
| | D: 86 mm | | |
| | H: 70 mm | | |

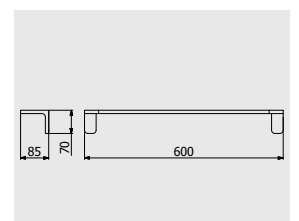

ARTICLE | ARTICOLO | ARTICLE

AA005

Towel holder
Porta salvietta
Porte-serviette

CODE / COEFFICIENT | CODICE /
COEFFICIENTE | CODE / COEFFICIENT

● CC AA005CC 2,5
● SS AA005SS 3,1

PACKAGING

📦 L: 450 mm ⚖️ 0,4 kg
D: 86 mm
H: 70 mm

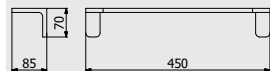

ARTICLE | ARTICOLO | ARTICLE

AA006

Towel holder
Porta salvietta
Porte-serviette

CODE / COEFFICIENT | CODICE /
COEFFICIENTE | CODE / COEFFICIENT

● CC AA006CC 2,3
● SS AA006SS 2,9

PACKAGING

📦 L: 300 mm ⚖️ 0,3 kg
D: 86 mm
H: 70 mm

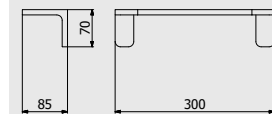

Taaac

ARTICLE | ARTICOLO | ARTICLE

AA008

Robe Hook
Appendino a parete
Cintre

CODE / COEFFICIENT | CODICE /
COEFFICIENTE | CODE / COEFFICIENT

● CC AA008CC 1,8
● SS AA008SS 2,3

PACKAGING

📦 L: 35 mm ⚖️ 0,2 kg
D: 50 mm
H: 112 mm

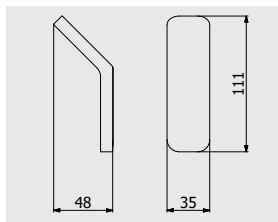

ARTICLE | ARTICOLO | ARTICLE

AA0011

Toilet paper holder
Porta rotolo
Porte rouleaux de toilette

CODE / COEFFICIENT | CODICE /
COEFFICIENTE | CODE / COEFFICIENT

● CC AA011CC 1,8
● SS AA011SS 2,3

PACKAGING

📦 L: 161 mm ⚖️ 0,2 kg
D: 86 mm
H: 80 mm

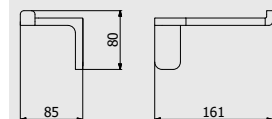

ARTICLE | ARTICOLO | ARTICLE

AA0012

Toilet brush holder
Porta scopino da terra
Porte balayette au sol

CODE / COEFFICIENT | CODICE /
COEFFICIENTE | CODE / COEFFICIENT

● CC AA012CC 3,8
● SS AA012SS 4,8

PACKAGING

📦 L: 80 mm ⚖️ 1,0 kg
D: 80 mm
H: 390 mm

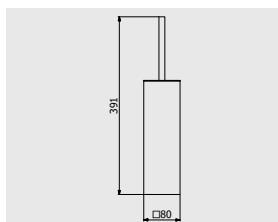

K2

Rounded and essential outlines is the language of elegance.

Contorni arrotondati ed essenziali sono il linguaggio dell'eleganza.
Les contours arrondis et essentiels sont le langage de l'élégance.

A faucet should give delightful sensations when used. K2 has a soft and pleasant shape. This contemporary collection is inspired to my style made of simplicity and clean features - it is very refined and pragmatic.

Rounded and essential outlines, which honour the elegant and sophisticated author's design, by soberly integrating in all kind of environment.

Un rubinetto dovrebbe dare sensazioni piacevoli quando lo si usa. K2 ha una forma morbida e gradevole. Questa collezione contemporanea si ispira al mio stile fatto di semplicità e linee pulite - è elegantissima e funzionale.

Tratti arrotondati ed essenziali, che mantengono tutta l'eleganza e la sofisticatezza del design d'autore, integrandosi sobriamente in tutti gli ambienti.

Un robinet devrait donner des sensations agréables lors de son utilisation. K2 possède une forme douce et agréable. Cette collection contemporaine est inspirée par mon style, fait de simplicité et de lignes épurées. Elle est très élégante et fonctionnelle. Les traits arrondis et essentiels conservent toute l'élégance et la sophistication du design de l'auteure, en s'intégrant sobrement dans tout environnement.



ANTI-LIMESCALE



CRYSTAL CLEAR
WATER



LEAD FREE



ZINC FREE







↑ K2209CC
 Mono hole wall mounted washbasin mixer
 Miscelatore lavabo a parete monoforo
 Mitigeur lavabo Mural monotrou

↙ K2200CC
 Monohole washbasin mixer
 Miscelatore lavabo monoforo
 Mitigeur lavabo

→ K2200CC
 Monohole washbasin mixer
 Miscelatore lavabo monoforo
 Mitigeur lavabo









➤ K2202RS
Tall monohole washbasin mixer
Miscelatore lavabo monoforo alto
Mitigeur lavabo haut

← K2202CC
Tall monohole washbasin mixer
Miscelatore lavabo monoforo alto
Mitigeur lavabo haut





↗ K2299CC
Monohole free-standing washbasin mixer
Miscelatore lavabo da terra
Mitigeur lavabo free standing

← K2210CC
Ceiling spout with wall mounted mixer
Bocca da soffitto con comando remoto ad incasso
Mitigeur lavabo mural avec bec plafond



← K2250CC
Wall mounted bath filler with hand shower kit
Bordo vasca esterno a parete di kit doccia
Mitigeur Bain/douche Mural avec douchette
encastrée

→ K2300CC
One way wall shower mixer
Miscelatore doccia a parete una via
Mitigeur douche mural une voie

↓ K2313CC
Two ways wall shower mixer complete with
shower kit
Miscelatore doccia a parete con deviatore due vie e
doccino integrato
Mitigeur douche mural deux voies avec
inverseur et douchette encastrée





- ↖ **K2350CC**
 Wall mounted shower mixer with shower kit
 Doccia esterno a parete di kit doccia
 Mitigeur de douche externe avec flexible et
 douchette
- ← **K2706CC**
 Exposed parts for bidet spray complete with
 mixer
 Set di parti esterne per Idroscopino igienico
 con miscelatore
 Partie extérieure pour douchette hygiénique
 avec mitigeur
- **K2800CC**
 Shower column with mixer and shower kit
 Colonna doccia con miscelatore e e kit doccia
 Colonne de douche avec mitigeur et kit douche



ARTICLE | ARTICOLO | ARTICLE

K2200



Monohole washbasin mixer complete with drain

Miscelatore lavabo monoforo completo di scarico automatico

Mitigeur Lavabo complet avec bonde automatique

CODE / COEFFICIENT | CODICE /
COEFFICIENTE | CODE / COEFFICIENT

| | | |
|------|---------|------|
| ● CC | K2200CC | 7,0 |
| ● PL | K2200PL | 11,2 |
| ● SS | K2200SS | 8,8 |
| ● BO | K2200BO | 8,4 |
| ● NP | K2200NP | 8,4 |
| ● II | K2200II | 10,5 |
| ● IS | K2200IS | 11,2 |
| ● RS | K2200RS | 10,5 |
| ● OO | K2200OO | 10,5 |

PACKAGING

 L: 340 mm
D: 180 mm
H: 70 mm

1,8 kg

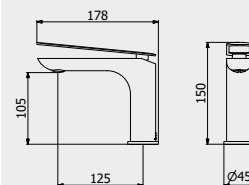

PORTATE | WATER FLOW | DÉBIT D'EAU

| | | |
|---------|---------|---------|
| 1 BAR | 2 BAR | 3 BAR |
| 3,5 l/m | 4,8 l/m | 5,2 l/m |

ARTICLE | ARTICOLO | ARTICLE

K2201



Mini monohole washbasin mixer complete with drain

Miscelatore lavabo monoforo mini completo di scarico automatico

Mitigeur lavabo Mini complet avec bonde automatique

CODE / COEFFICIENT | CODICE /
COEFFICIENTE | CODE / COEFFICIENT

| | | |
|------|---------|-----|
| ● CC | K2201CC | 6,0 |
| ● PL | K2201PL | 9,6 |
| ● SS | K2201SS | 7,5 |
| ● BO | K2201BO | 7,2 |
| ● NP | K2201NP | 7,2 |
| ● II | K2201II | 9,0 |
| ● IS | K2201IS | 9,6 |
| ● RS | K2201RS | 9,0 |
| ● OO | K2201OO | 9,0 |

PACKAGING

 L: 340 mm
D: 180 mm
H: 70 mm

1,4 kg

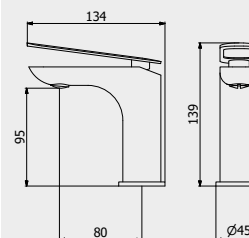

PORTATE | WATER FLOW | DÉBIT D'EAU

| | | |
|---------|---------|---------|
| 1 BAR | 2 BAR | 3 BAR |
| 3,5 l/m | 4,8 l/m | 5,2 l/m |

ARTICLE | ARTICOLO | ARTICLE

K2202



Tall monohole washbasin mixer complete with drain

Miscelatore lavabo monoforo alto completo di scarico automatico

Mitigeur lavabo Haut complet avec bonde automatique

CODE / COEFFICIENT | CODICE /
COEFFICIENTE | CODE / COEFFICIENT

| | | |
|------|---------|------|
| ● CC | K2202CC | 9,2 |
| ● PL | K2202PL | 14,7 |
| ● SS | K2202SS | 11,5 |
| ● BO | K2202BO | 11,0 |
| ● NP | K2202NP | 11,0 |
| ● II | K2202II | 13,8 |
| ● IS | K2202IS | 14,7 |
| ● RS | K2202RS | 13,8 |
| ● OO | K2202OO | 13,8 |

PACKAGING

 L: 370 mm
D: 270 mm
H: 80 mm

2,4 kg

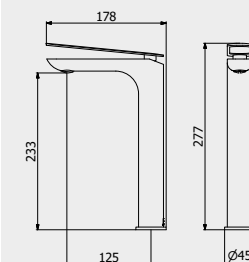

PORTATE | WATER FLOW | DÉBIT D'EAU

| | | |
|---------|---------|---------|
| 1 BAR | 2 BAR | 3 BAR |
| 3,5 l/m | 4,8 l/m | 5,2 l/m |



ARTICLE | ARTICOLO | ARTICLE

K2209



Monohole wall mounted washbasin mixer

Miscelatore lavabo a parete monoforo completo di scarico automatico

Mitigeur lavabo mural monotrou complet avec bonde automatique

| CODE / COEFFICIENT | CODICE / COEFFICIENTE | COEFFICIENT |
|--------------------|-----------------------|-------------|
| CC | K2209CC | 13,1 |
| PL | K2209PL | 21,0 |
| SS | K2209SS | 16,4 |
| BO | K2209BO | 15,7 |
| NP | K2209NP | 15,7 |
| II | K2209II | 19,7 |
| IS | K2209IS | 21,0 |
| RS | K2209RS | 19,7 |
| OO | K2209OO | 19,7 |

PACKAGING

L: 425 mm
D: 188 mm
H: 98 mm

3,3 kg

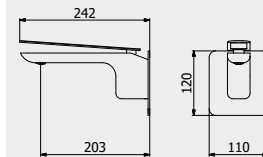

PORTATE | WATER FLOW | DÉBIT D'EAU

| 1 BAR | 2 BAR | 3 BAR |
|---------|-------|---------|
| 3,9 l/m | 5 l/m | 5,2 l/m |

ARTICLE | ARTICOLO | ARTICLE

K2210

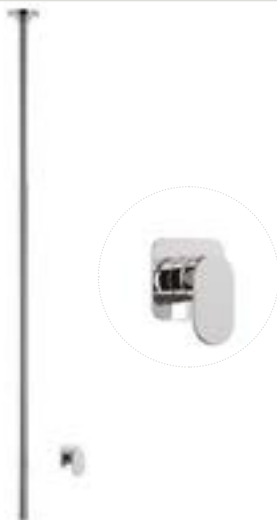

Ceiling spout with wall mounted mixer

Bocca da soffitto con comando remoto ad incasso

Mitigeur lavabo mural avec bec plafond complet avec bonde automatique

| CODE / COEFFICIENT | CODICE / COEFFICIENTE | COEFFICIENT |
|--------------------|-----------------------|-------------|
| CC | EK2210CC | 27,5 |
| SS | EK2210SS | 34,4 |
| BO | EK2210BO | 33,0 |
| NP | EK2210NP | 33,0 |

PACKAGING

L: 150 mm
D: 190 mm
H: 98 mm

L: 1700 mm
Ø: 70 mm

4,5 kg

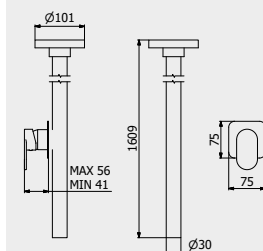

PORTATE | WATER FLOW | DÉBIT D'EAU

| 1 BAR | 2 BAR | 3 BAR |
|---------|---------|-----------|
| 6,4 l/m | 8,9 l/m | 11,00 l/m |

Built-in body to be purchased separately

Corpo incasso da acquistare separatamente

Corps intégré à acheter séparément



CODICE | CODE | CODE

INC300XXXN_19

COEFFICIENTE | COEFFICIENT | COEFFICIENT

1,8

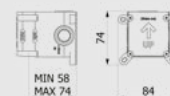

K2

ARTICLE | ARTICOLO | ARTICLE

K2299



Monohole free-standing washbasin mixer complete with drain
 Miscelatore lavabo da terra completo di scarico automatico
 Mitigeur Lavabo Free standing complet avec bonde automatique

| CODE / COEFFICIENT | CODICE / COEFFICIENTE | CODE / COEFFICIENT |
|--------------------|-----------------------|--------------------|
| CC | EK2299CC | 28,8 |
| PL | EK2299PL | 46,0 |
| SS | EK2299SS | 35,9 |
| BO | EK2299BO | 34,5 |
| NP | EK2299NP | 34,5 |
| II | EK2299II | 43,1 |
| IS | EK2299IS | 46,0 |
| RS | EK2299RS | 43,1 |
| OO | EK2299OO | 43,1 |

PACKAGING

L: 1160 mm
D: 360 mm
H: 180 mm

11,2 kg

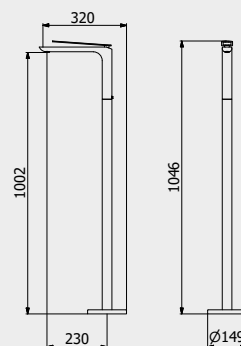

PORTATE | WATER FLOW | DÉBIT D'EAU

| | | |
|---------|---------|---------|
| 1 BAR | 2 BAR | 3 BAR |
| 3,6 l/m | 5,1 l/m | 5,5 l/m |

Built-in body to be purchased separately
 AVAILABLE FROM JANUARY 2020

Corpo incasso da acquistare separatamente
 DISPONIBILE DA GENNAIO 2020

Corps intégré à acheter séparément
 DISPONIBLE À PARTIR DE JANVIER 2020



CODICE | CODE | CODE

INC399XXXN_19

COEFFICIENTE | COEFFICIENT | COEFFICIENT

2,8

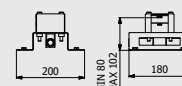

ARTICLE | ARTICOLO | ARTICLE

K2220



Monohole bidet mixer complete with drain
 Miscelatore bidet monoforo completo di scarico automatico
 Mitigeur bidet complet avec bonde automatique

| CODE / COEFFICIENT | CODICE / COEFFICIENTE | CODE / COEFFICIENT |
|--------------------|-----------------------|--------------------|
| CC | K2220CC | 6,5 |
| PL | K2220PL | 10,4 |
| SS | K2220SS | 8,1 |
| BO | K2220BO | 7,8 |
| NP | K2220NP | 7,8 |
| II | K2220II | 9,8 |
| IS | K2220IS | 10,4 |
| RS | K2220RS | 9,8 |
| OO | K2220OO | 9,8 |

PACKAGING

L: 340 mm
D: 180 mm
H: 70 mm

1,7 kg

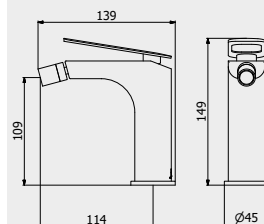

PORTATE | WATER FLOW | DÉBIT D'EAU

| | | |
|---------|---------|---------|
| 1 BAR | 2 BAR | 3 BAR |
| 3,5 l/m | 4,9 l/m | 5,4 l/m |

ARTICLE | ARTICOLO | ARTICLE

K2300



Exposed parts for manual wall mixer
 Set di parti esterne per miscelatore a parete ad una via
 Partie extérieure pour mitigeur encastré à une voie

| CODE / COEFFICIENT | CODICE / COEFFICIENTE | CODE / COEFFICIENT |
|--------------------|-----------------------|--------------------|
| CC | EK2300CC | 4,1 |
| PL | EK2300PL | 6,6 |
| SS | EK2300SS | 5,1 |
| BO | EK2300BO | 4,9 |
| NP | EK2300NP | 4,9 |
| II | EK2300II | 6,2 |
| IS | EK2300IS | 6,6 |
| RS | EK2300RS | 6,2 |
| OO | EK2300OO | 6,2 |

PACKAGING

L: 150 mm
D: 190 mm
H: 98 mm

1,7 kg

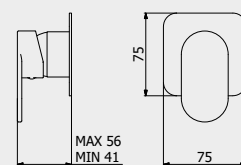

PORTATE | WATER FLOW | DÉBIT D'EAU

| | | |
|----------|----------|--------|
| 1 BAR | 2 BAR | 3 BAR |
| 11,5 l/m | 16,3 l/m | 20 l/m |

Built-in body to be purchased separately

Corpo incasso da acquistare separatamente

Corps intégré à acheter séparément



CODICE | CODE | CODE

INC300XXXN_19

COEFFICIENTE | COEFFICIENT | COEFFICIENT

1,8

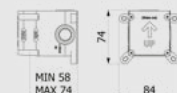

ARTICLE | ARTICOLO | ARTICLE

K2310



Exposed parts for manual wall mixer with two ways diverter
Miscelatore doccia a parete con deviatore due vie
Mitigeur douche mural deux voies avec inverseur

| CODE / COEFFICIENT | CODICE / COEFFICIENTE | COEFFICIENT |
|--------------------|-----------------------|-------------|
| CC | EK2310CC | 6,1 |
| PL | EK2310PL | 9,8 |
| SS | EK2310SS | 7,6 |
| BO | EK2310BO | 7,3 |
| NP | EK2310NP | 7,3 |
| II | EK2310II | 9,2 |
| IS | EK2310IS | 9,8 |
| RS | EK2310RS | 9,2 |
| OO | EK2310OO | 9,2 |

PACKAGING

L: 150 mm
D: 190 mm
H: 98 mm
1,8 kg

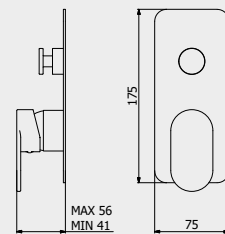

PORTATE | WATER FLOW | DÉBIT D'EAU

| 1 BAR | 2 BAR | 3 BAR |
|---------|----------|--------|
| 9,2 l/m | 12,8 l/m | 16 l/m |

K2

Built-in body to be purchased separately

Corpo incasso da acquistare separatamente

Corps intégré à acheter séparément



CODICE | CODE | CODE

INC310XXXN_19

COEFFICIENTE | COEFFICIENT | COEFFICIENT

3,3

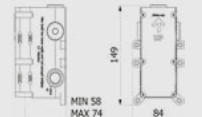

ARTICLE | ARTICOLO | ARTICLE

K2312



Exposed parts for manual wall mixer with three ways diverter
Set di parti esterne per miscelatore a parete a tre vie
Mitigeur douche mural trois voies avec inverseur

| CODE / COEFFICIENT | CODICE / COEFFICIENTE | COEFFICIENT |
|--------------------|-----------------------|-------------|
| CC | EK2312CC | 7,4 |
| PL | EK2312PL | 11,8 |
| SS | EK2312SS | 9,3 |
| BO | EK2312BO | 8,9 |
| NP | EK2312NP | 8,9 |
| II | EK2312II | 11,1 |
| IS | EK2312IS | 11,8 |
| RS | EK2312RS | 11,1 |
| OO | EK2312OO | 11,1 |

PACKAGING

L: 150 mm
D: 190 mm
H: 98 mm
1,8 kg

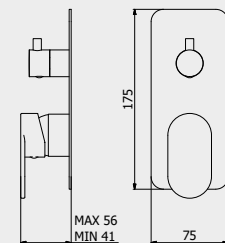

PORTATE | WATER FLOW | DÉBIT D'EAU

| 1 BAR | 2 BAR | 3 BAR |
|---------|----------|----------|
| 8,3 l/m | 11,7 l/m | 14,3 l/m |

Built-in body to be purchased separately

Corpo incasso da acquistare separatamente

Corps intégré à acheter séparément



CODICE | CODE | CODE

INC312XXXN_19

COEFFICIENTE | COEFFICIENT | COEFFICIENT

3,3

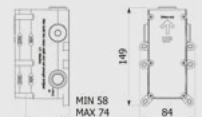

ARTICLE | ARTICOLO | ARTICLE

K2313



Exposed parts for manual wall mixer with 2 ways with shower kit
Set di parti esterne per miscelatore a parete a due vie completo di kit doccia
Partie extérieure pour mitigeur encastré à deux voies avec douchette

| CODE / COEFFICIENT | CODICE / COEFFICIENTE | COEFFICIENT |
|--------------------|-----------------------|-------------|
| CC | EK2313CC | 10,1 |
| PL | EK2313PL | 16,2 |
| SS | EK2313SS | 12,6 |
| BO | EK2313BO | 12,1 |
| NP | EK2313NP | 12,1 |
| II | EK2313II | 15,2 |
| IS | EK2313IS | 16,2 |
| RS | EK2313RS | 15,2 |
| OO | EK2313OO | 15,2 |

PACKAGING

L: 370 mm
D: 270 mm
H: 80 mm
2,2 kg

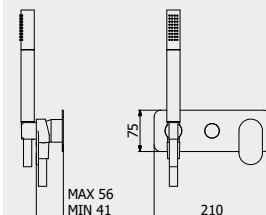

PORTATE | WATER FLOW | DÉBIT D'EAU

| 1 BAR | 2 BAR | 3 BAR |
|--------|----------|----------|
| 10 l/m | 14,1 l/m | 17,2 l/m |

Built-in body to be purchased separately

Corpo incasso da acquistare separatamente

Corps intégré à acheter séparément



CODICE | CODE | CODE

INC313XXXN_19

COEFFICIENTE | COEFFICIENT | COEFFICIENT

3,6



ARTICLE | ARTICOLO | ARTICLE

K2314



Exposed parts for manual wall mixer with 3 ways with shower kit
Set di parti esterne per miscelatore a parete a tre vie completo di kit doccia
Partie extérieure pour mitigeur encastré à trois voies avec douchette

| CODE / COEFFICIENT | CODICE / COEFFICIENTE | COEFFICIENT |
|--------------------|-----------------------|-------------|
| CC | EK2314CC | 11,4 |
| PL | EK2314PL | 18,2 |
| SS | EK2314SS | 14,3 |
| BO | EK2314BO | 13,7 |
| NP | EK2314NP | 13,7 |
| II | EK2314II | 17,1 |
| IS | EK2314IS | 18,2 |
| RS | EK2314RS | 17,1 |
| OO | EK2314OO | 17,1 |

PACKAGING

L: 370 mm
D: 270 mm
H: 80 mm

2,2 kg

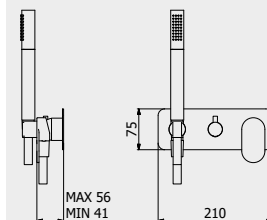

PORTATE | WATER FLOW | DÉBIT D'EAU

| | | |
|---------|----------|----------|
| 1 BAR | 2 BAR | 3 BAR |
| 8,3 l/m | 11,7 l/m | 14,3 l/m |

Built-in body to be purchased separately

Corpo incasso da acquistare separatamente

Corps intégré à acheter séparément



CODICE | CODE | CODE

INC314XXXN_19

COEFFICIENTE | COEFFICIENT | COEFFICIENT

3,7



ARTICLE | ARTICOLO | ARTICLE

K2800



Shower column with mixer and shower kit
Colonna doccia con miscelatore e e kit doccia
Colonne de douche avec mitigeur et kit douche

| CODE / COEFFICIENT | CODICE / COEFFICIENTE | COEFFICIENT |
|--------------------|-----------------------|-------------|
| CC | K2800CC | 26,7 |

PACKAGING

L: 1200 mm
D: 400 mm
H: 170 mm

11,6 kg

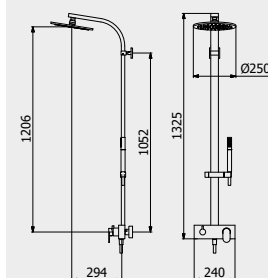

PORTATE | WATER FLOW | DÉBIT D'EAU

| | | |
|---------|---------|-----------|
| 1 BAR | 2 BAR | 3 BAR |
| 6,4 l/m | 8,9 l/m | 11,00 l/m |

ARTICLE | ARTICOLO | ARTICLE

K2350



Wall mounted shower mixer with shower kit
Doccia esterno a parete completo di kit doccia
Mitigeur de douche externe avec flexible et douchette

| CODE / COEFFICIENT | CODICE / COEFFICIENTE | COEFFICIENT |
|--------------------|-----------------------|-------------|
| CC | K2350CC | 10,9 |
| PL | K2350PL | 17,4 |
| SS | K2350SS | 13,6 |
| BO | K2350BO | 13,1 |
| NP | K2350NP | 13,1 |
| II | K2350II | 16,4 |
| IS | K2350IS | 17,4 |
| RS | K2350RS | 16,4 |
| OO | K2350OO | 16,4 |

PACKAGING

L: 360 mm
D: 220 mm
H: 150 mm

3,5 kg

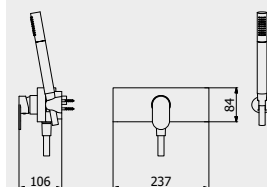

PORTATE | WATER FLOW | DÉBIT D'EAU

| | | |
|----------|----------|----------|
| 1 BAR | 2 BAR | 3 BAR |
| 11,5 l/m | 18,4 l/m | 23,3 l/m |



ARTICLE | ARTICOLO | ARTICLE

K2399



Free-standing bath filler with shower kit

Bordo vasca da terra con kit doccia

Bain douche complet alimentation au sol

CODE / COEFFICIENT | CODICE /
COEFFICIENTE | CODE / COEFFICIENT

| | | |
|----|----------|------|
| CC | EK2399CC | 32,6 |
| PL | EK2399PL | 52,2 |
| SS | EK2399SS | 40,8 |
| BO | EK2399BO | 39,1 |
| NP | EK2399NP | 39,1 |
| II | EK2399II | 48,9 |
| IS | EK2399IS | 52,2 |
| RS | EK2399RS | 48,9 |
| OO | EK2399OO | 48,9 |

PACKAGING

L: 1160 mm
D: 360 mm
H: 180 mm

14 kg

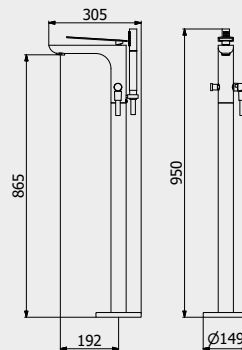

PORTATE | WATER FLOW | DÉBIT D'EAU

| | | |
|--------|--------|--------|
| 1 BAR | 2 BAR | 3 BAR |
| 13 l/m | 19 l/m | 24 l/m |

Built-in body to be purchased separately

AVAILABLE FROM JANUARY 2020

Corpo incasso da acquistare separatamente
DISPONIBILE DA GENNAIO 2020

Corps intégré à acheter séparément
DISPONIBLE À PARTIR DE JANVIER 2020



CODICE | CODE | CODE

INC399XXXN_19

COEFFICIENTE | COEFFICIENT | COEFFICIENT

2,8

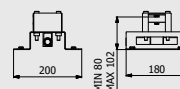

ARTICLE | ARTICOLO | ARTICLE

K2250



Wall mounted bath filler complete with hand shower kit

Bordo vasca esterno a parete completo di kit doccia

Mitigeur Bain/douche Mural avec douchette encastrée

CODE / COEFFICIENT | CODICE /
COEFFICIENTE | CODE / COEFFICIENT

| | | |
|----|---------|------|
| CC | K2250CC | 15,3 |
| PL | K2250PL | 24,5 |
| SS | K2250SS | 19,1 |
| BO | K2250BO | 18,4 |
| NP | K2250NP | 18,4 |
| II | K2250II | 23,0 |
| IS | K2250IS | 24,5 |
| RS | K2250RS | 23,0 |
| OO | K2250OO | 23,0 |

PACKAGING

L: 353 mm
D: 225 mm
H: 226 mm

4,9 kg

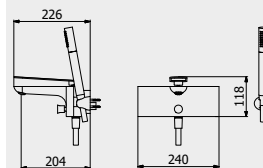

PORTATE | WATER FLOW | DÉBIT D'EAU

| | | |
|---------|----------|----------|
| 1 BAR | 2 BAR | 3 BAR |
| 9,2 l/m | 14,2 l/m | 17,6 l/m |

ARTICLE | ARTICOLO | ARTICLE

RU319



Wall mounted waterfall

Cascata a parete con erogazione diretta

Cascade murale

CODE / COEFFICIENT | CODICE /
COEFFICIENTE | CODE / COEFFICIENT

| | | |
|----|---------|------|
| CC | RU319CC | 12,8 |
| SS | RU319SS | 16,0 |
| BO | RU319BO | 15,4 |
| NP | RU319NP | 15,4 |
| CF | RU319CF | 19,2 |
| CS | RU319CS | 20,5 |
| II | RU319II | 19,2 |
| IS | RU319IS | 20,5 |
| RS | RU319RS | 19,2 |
| SR | RU319SR | 20,5 |
| OO | RU319OO | 19,2 |
| OS | RU319OS | 20,5 |

PACKAGING

L: 340 mm
D: 180 mm
H: 70 mm

3,1 kg

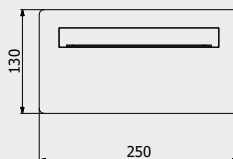

PORTATE | WATER FLOW | DÉBIT D'EAU

| | | |
|--------|--------|--------|
| 1 BAR | 2 BAR | 3 BAR |
| 13 l/m | 17 l/m | 20 l/m |

ARTICLE | ARTICOLO | ARTICLE

K2320



Wall mounted spout

Bocca d'erogazione a parete

Bec de remplissage mural

CODE / COEFFICIENT | CODICE /
COEFFICIENTE | CODE / COEFFICIENT

| | | |
|----|---------|-----|
| CC | K2320CC | 2,1 |
| PL | K2320PL | 3,4 |
| SS | K2320SS | 2,6 |
| BO | K2320BO | 2,5 |
| NP | K2320NP | 2,5 |
| II | K2320II | 3,2 |
| IS | K2320IS | 3,4 |
| RS | K2320RS | 3,2 |
| OO | K2320OO | 3,2 |

PACKAGING

L: 175 mm
D: 125 mm
H: 90 mm

0,24 kg

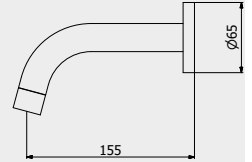

PORTATE | WATER FLOW | DÉBIT D'EAU

| | | |
|--------|-------|--------|
| 1 BAR | 2 BAR | 3 BAR |
| 10 l/m | 14l/m | 17 l/m |

ARTICLE | ARTICOLO | ARTICLE

K2321



Short wall mounted spout

Bocca d'erogazione corta a parete

Bec de remplissage mural court

CODE / COEFFICIENT | CODICE /
COEFFICIENTE | CODE / COEFFICIENT

| | | |
|----|---------|-----|
| CC | K2321CC | 2,5 |
| PL | K2321PL | 4,0 |
| SS | K2321SS | 3,1 |
| BO | K2321BO | 3,0 |
| NP | K2321NP | 3,0 |
| II | K2321II | 3,8 |
| IS | K2321IS | 4,0 |
| RS | K2321RS | 3,8 |
| OO | K2321OO | 3,8 |

PACKAGING

L: 175 mm
D: 125 mm
H: 90 mm

0,23 kg

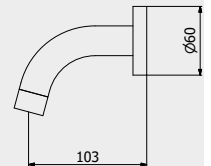

PORTATE | WATER FLOW | DÉBIT D'EAU

| | | |
|--------|-------|--------|
| 1 BAR | 2 BAR | 3 BAR |
| 10 l/m | 14l/m | 17 l/m |

ARTICLE | ARTICOLO | ARTICLE

K2322



Long wall mounted spout

Bocca d'erogazione lunga a parete

Bec de remplissage mural long

CODE / COEFFICIENT | CODICE /
COEFFICIENTE | CODE / COEFFICIENT

| | | |
|----|---------|-----|
| CC | K2322CC | 2,5 |
| PL | K2322PL | 4,0 |
| SS | K2322SS | 3,1 |
| BO | K2322BO | 3,0 |
| NP | K2322NP | 3,0 |
| II | K2322II | 3,8 |
| IS | K2322IS | 4,0 |
| RS | K2322RS | 3,8 |
| OO | K2322OO | 3,8 |

PACKAGING

L: 175 mm
D: 125 mm
H: 90 mm

0,25 kg

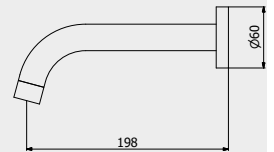

PORTATE | WATER FLOW | DÉBIT D'EAU

| | | |
|--------|-------|--------|
| 1 BAR | 2 BAR | 3 BAR |
| 10 l/m | 14l/m | 17 l/m |



ARTICLE | ARTICOLO | ARTICLE

K2706



Exposed parts for bidet spray complete with mixer
 Set di parti esterne per Idroscopino igienico con miscelatore
 Partie extérieure pour douchette hygiénique avec mitigeur

| CODE / COEFFICIENT | CODICE / COEFFICIENTE | COEFFICIENT |
|--------------------|-----------------------|-------------|
| CC | EK2706CC | 9,8 |
| PL | EK2706PL | 15,7 |
| SS | EK2706SS | 12,3 |
| BO | EK2706BO | 11,8 |
| NP | EK2706NP | 11,8 |
| II | EK2706II | 14,7 |
| IS | EK2706IS | 15,7 |
| RS | EK2706RS | 14,7 |
| OO | EK2706OO | 14,7 |

PACKAGING

L: 370 mm
 D: 270 mm
 H: 80 mm
 3,1 kg

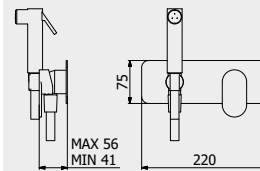

PORTATE | WATER FLOW | DÉBIT D'EAU

| 1 BAR | 2 BAR | 3 BAR |
|---------|---------|-------|
| 2,3 l/m | 3,2 l/m | 4 l/m |

K2

Built-in body to be purchased separately

Corpo incasso da acquistare separatamente

Corps intégré à acheter séparément



CODICE | CODE | CODE

INC206XXXN_19

COEFFICIENTE | COEFFICIENT | COEFFICIENT

2,9



MODERNA / ACCESSORIES COLLECTION

ARTICLE | ARTICOLO | ARTICLE

MO001

Wall soap-holder

Porta sapone a muro

Porte distributeur de savon encastré

CODE / COEFFICIENT | CODICE /
COEFFICIENTE | CODE / COEFFICIENT

CC MO001CC 1,5

PACKAGING

L: 110 mm
 D: 130 mm
 H: 50 mm
 0,4 kg

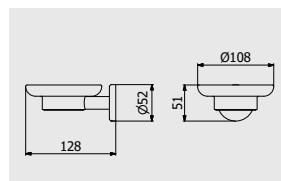

ARTICLE | ARTICOLO | ARTICLE

MO002

Wall soap dispenser holder

Porta dispenser sapone liquido a parete

Porte distributeur de savon en verre gravé

CODE / COEFFICIENT | CODICE /
COEFFICIENTE | CODE / COEFFICIENT

CC MO002CC 2,3

PACKAGING

L: 80 mm
 D: 130 mm
 H: 180 mm
 0,1 kg

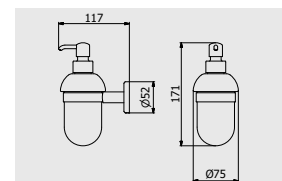

ARTICLE | ARTICOLO | ARTICLE

MO003

Wall toothbrush holder

Bicchieri porta spazzolino a parete

Porte-verre en verre gravé

CODE / COEFFICIENT | CODICE /
COEFFICIENTE | CODE / COEFFICIENT

CC MO003CC 1,5

PACKAGING

L: 70 mm
 D: 110 mm
 H: 100 mm
 0,4 kg

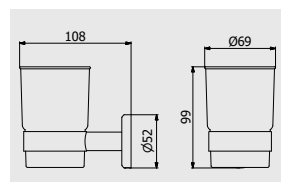

ARTICLE | ARTICOLO | ARTICLE

MO004

Towel holder

Porta salvietta

Porte-serviette

CODE / COEFFICIENT | CODICE /
COEFFICIENTE | CODE / COEFFICIENT

CC MO004CC 2,4

PACKAGING

L: 650 mm
 D: 70 mm
 H: 50 mm
 0,5 kg

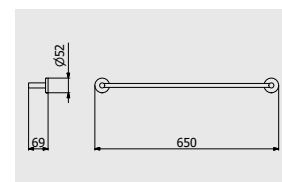

ARTICLE | ARTICOLO | ARTICLE

MO014

Towel holder

Porta salvietta

Porte-serviette

CODE / COEFFICIENT | CODICE /
COEFFICIENTE | CODE / COEFFICIENT

CC MO014CC 2,2

PACKAGING

L: 500 mm
 D: 70 mm
 H: 50 mm
 0,5 kg

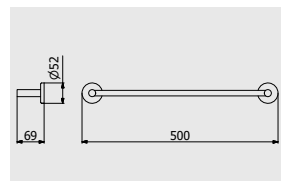

ARTICLE | ARTICOLO | ARTICLE

MO006

Towel holder

Porta salvietta

Porte-serviette

CODE / COEFFICIENT | CODICE /
COEFFICIENTE | CODE / COEFFICIENT

CC MO006CC 2,1

PACKAGING

L: 350 mm
 D: 70 mm
 H: 50 mm
 0,4 kg

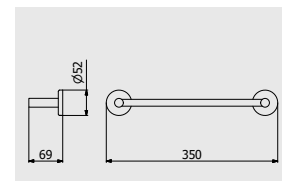

ARTICLE | ARTICOLO | ARTICLE

MO007

Ring Towel holder

Porta salvietta ad anello

Porte-serviettes anneau

CODE / COEFFICIENT | CODICE /
COEFFICIENTE | CODE / COEFFICIENT

CC MO007CC 1,6

PACKAGING

L: 180 mm 0,8 kg
D: 70 mm
H: 200 mm

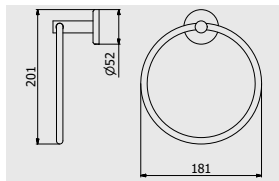

ARTICLE | ARTICOLO | ARTICLE

MO008

Robe Hook

Appendino a parete

Cintre

CODE / COEFFICIENT | CODICE /
COEFFICIENTE | CODE / COEFFICIENT

CC MO008CC 0,9

PACKAGING

L: 50 mm 0,3 kg
D: 50 mm
H: 50 mm

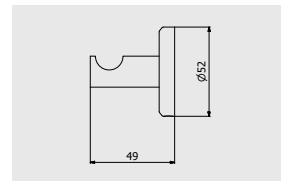

ARTICLE | ARTICOLO | ARTICLE

MO009

Double robe hook

Doppio appendino a parete

Double cintre

CODE / COEFFICIENT | CODICE /
COEFFICIENTE | CODE / COEFFICIENT

CC MO009CC 1,4

PACKAGING

L: 70 mm 0,1 kg
D: 70 mm
H: 50 mm

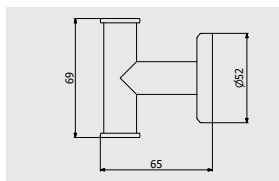

ARTICLE | ARTICOLO | ARTICLE

MO010

Shelf

Mensola

Etagère

CODE / COEFFICIENT | CODICE /
COEFFICIENTE | CODE / COEFFICIENT

CC MO010CC 3,0

PACKAGING

L: 600 mm 0,3 kg
D: 140 mm
H: 50 mm

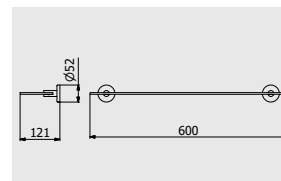

ARTICLE | ARTICOLO | ARTICLE

MO005

Swiveable towel holder

Porta salvietta doppio

Porte-serviettes noeud

CODE / COEFFICIENT | CODICE /
COEFFICIENTE | CODE / COEFFICIENT

CC MO005CC 3,5

PACKAGING

L: 430 mm 0,5 kg
D: 70 mm
H: 50 mm

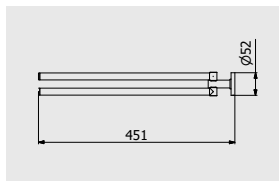

ARTICLE | ARTICOLO | ARTICLE

MO011

Toilet paper holder

Porta rotolo

Porte rouleaux de toilette

CODE / COEFFICIENT | CODICE /
COEFFICIENTE | CODE / COEFFICIENT

CC MO011CC 1,4

PACKAGING

L: 150 mm 0,2 kg
D: 70 mm
H: 50 mm

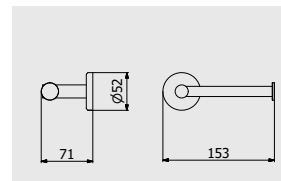

ARTICLE | ARTICOLO | ARTICLE

MO012

Toilet brush holder

Porta scopino da terra

Porte balayette au sol

CODE / COEFFICIENT | CODICE /
COEFFICIENTE | CODE / COEFFICIENT

CC MO012CC 2,5

PACKAGING

L: 80 mm 0,7 kg
D: 80 mm
H: 380 mm

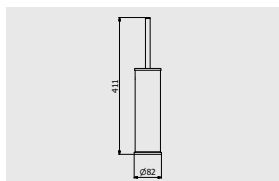

ARTICLE | ARTICOLO | ARTICLE

MO013

Wall toilet brush holder

Porta scopino da parete

Porte balayette

CODE / COEFFICIENT | CODICE /
COEFFICIENTE | CODE / COEFFICIENT

CC MO013CC 2,9

PACKAGING

L: 80 mm 0,7 kg
D: 80 mm
H: 380 mm

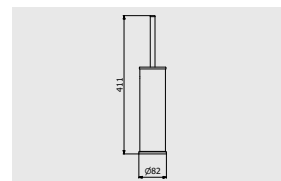

K3

Sharp and essential outlines is the language of elegance.

Contorni netti ed essenziali sono il linguaggio dell'eleganza.
Les contours nets et essentiels sont le langage de l'élégance.

K3 incorporates the elegance and sobriety of the K2 twin collection, but with a slightly sharper cut, thanks to the square shapes at the base and in the lever that add a touch of unpredictability and character to a collection still recognizable for its refinement and its aesthetic measure.

K3 riprende l'eleganza e la sobrietà della linea gemella K2, ma con un taglio leggermente più deciso, dalle forme squadrate alla base e nella leva del rubinetto che aggiungono un tocco di imprevedibilità e carattere a un serie sempre riconoscibile per la sua eleganza e misura estetica.

K3 incorpore l'élégance et la sobriété de la ligne jumelle K2, mais avec une touche légèrement plus résolu, avec ses formes carrées à la base et au levier qui ajoutent une touche d'imprévisibilité et de caractère à une série toujours reconnaissable pour son élégance et sa mesure esthétique.



ANTI-LIMESCALE



CRYSTAL CLEAR
WATER



LEAD FREE



ZINC FREE







- ↑ **K3209CC**
 Monohole wall mounted washbasin mixer
 Miscelatore lavabo a parete monoforo
 Mitigeur lavabo mural monotrou
- ← **K3202CC**
 Tall monohole washbasin mixer
 Miscelatore lavabo monoforo alto
 Mitigeur lavabo haut
- **K3200CC**
 Monohole washbasin mixer
 Miscelatore lavabo monoforo
 Mitigeur lavabo







← **K3200NP**
Monohole washbasin mixer
Miscelatore lavabo monoforo
Mitigeur lavabo

↑ **K3200NP**
Monohole washbasin mixer
Miscelatore lavabo monoforo
Mitigeur lavabo

K3300NP
One way wall shower mixer
Miscelatore doccia a parete una via
Mitigeur douche mural une voie

→ **K3314CC**
Three ways wall shower mixer complete with shower kit
Miscelatore doccia a parete con deviatore tre vie e doccia integrato
Mitigeur douche mural trois voies avec inverseur et douchette encastrée







K3

← K3202NP
Tall monohole washbasin mixer
Miscelatore lavabo monoforo alto
Mitigeur lavabo haut

↗ K3299CC
Monohole free-standing washbasin mixer
Miscelatore lavabo da terra
Mitigeur lavabo free standing



↑ **K3250CC**
Wall mounted bath filler with hand shower kit
Bordo vasca esterno a parete di kit doccia
Mitigeur Bain/douche Mural avec douchette
encastrée

→ **K3800CC**
Shower column with mixer and shower kit
Colonna doccia con miscelatore e e kit doccia
Colonne de douche avec mitigeur et kit douche

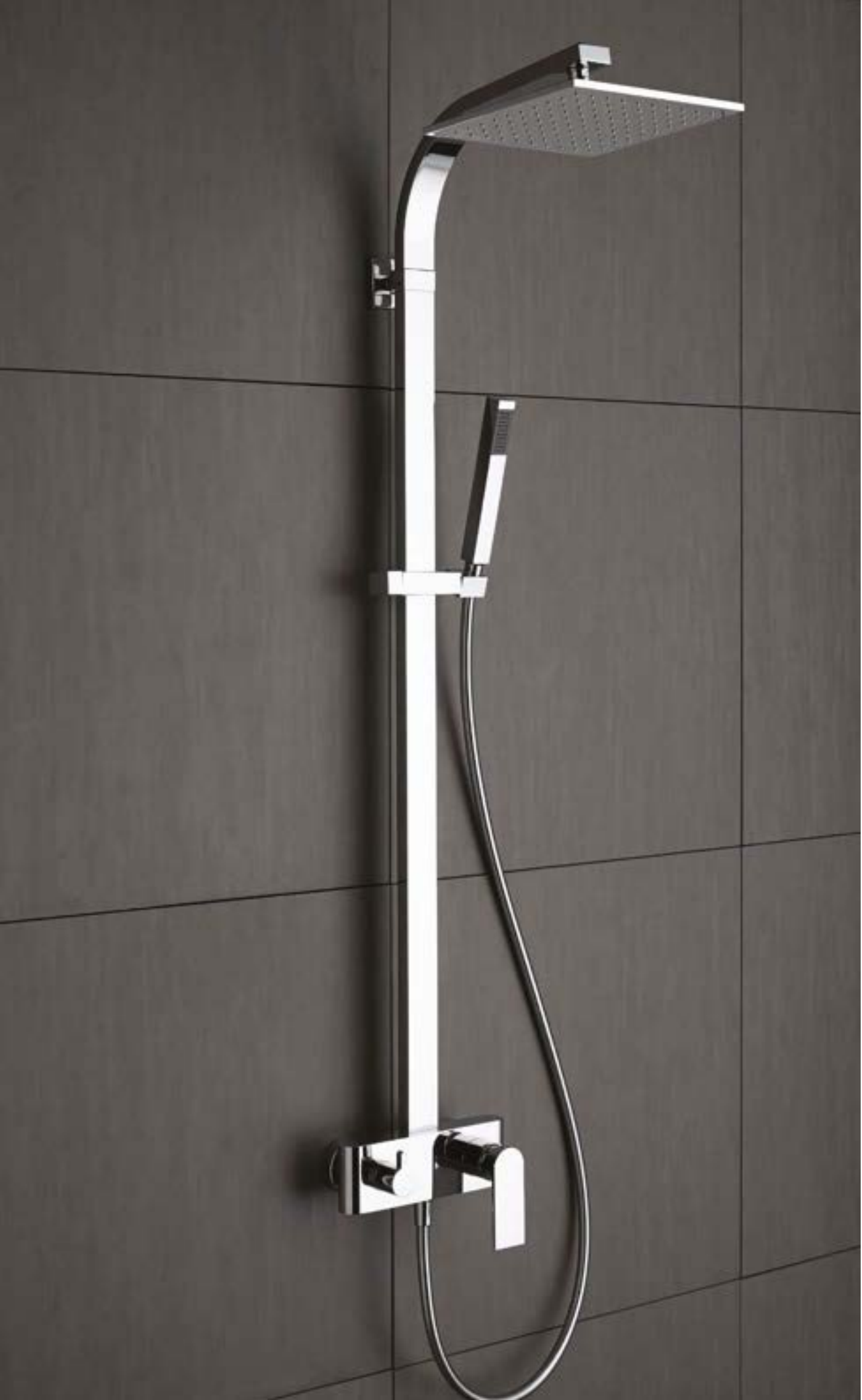

ARTICLE | ARTICOLO | ARTICLE

K3200



Monohole washbasin mixer complete with drain

Miscelatore lavabo monoforo completo di scarico automatico

Mitigeur lavabo complet avec bonde automatique

CODICE / COEFFICIENTE | CODE /
COEFFICIENT | CODE / COEFFICIENT

| | | |
|------|---------|------|
| ● CC | K3200CC | 7,7 |
| ● SS | K3200SS | 9,6 |
| ● BO | K3200BO | 9,2 |
| ● NP | K3200NP | 9,2 |
| ● II | K3200II | 11,6 |
| ● IS | K3200IS | 12,3 |
| ● RS | K3200RS | 11,6 |
| ● OO | K3200OO | 11,6 |

PACKAGING

L: 340 mm
D: 180 mm
H: 70 mm

2,0 kg

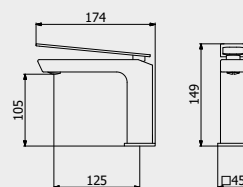

PORTATE | WATER FLOW | DÉBIT D'EAU

| | | |
|---------|---------|---------|
| 1 BAR | 2 BAR | 3 BAR |
| 3,5 l/m | 4,8 l/m | 5,2 l/m |

ARTICLE | ARTICOLO | ARTICLE

K3201



Mini monohole washbasin mixer complete with drain

Miscelatore lavabo monoforo mini completo di scarico automatico

Mitigeur lavabo mini complet avec bonde automatique

CODICE / COEFFICIENTE | CODE /
COEFFICIENT | CODE / COEFFICIENT

| | | |
|------|---------|------|
| ● CC | K3201CC | 6,4 |
| ● SS | K3201SS | 8,0 |
| ● BO | K3201BO | 7,7 |
| ● NP | K3201NP | 7,7 |
| ● II | K3201II | 9,6 |
| ● IS | K3201IS | 10,2 |
| ● RS | K3201RS | 9,6 |
| ● OO | K3201OO | 9,6 |

PACKAGING

L: 340 mm
D: 180 mm
H: 70 mm

1,8 kg

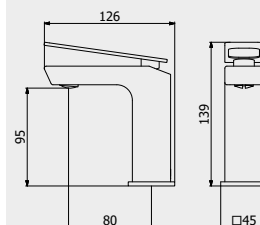

PORTATE | WATER FLOW | DÉBIT D'EAU

| | | |
|---------|---------|---------|
| 1 BAR | 2 BAR | 3 BAR |
| 3,9 l/m | 4,9 l/m | 5,4 l/m |

ARTICLE | ARTICOLO | ARTICLE

K3202



Tall monohole washbasin mixer complete with drain

Miscelatore lavabo monoforo alto completo di scarico automatico

Mitigeur lavabo haut complet avec bonde automatique

CODICE / COEFFICIENTE | CODE /
COEFFICIENT | CODE / COEFFICIENT

| | | |
|------|---------|------|
| ● CC | K3202CC | 11,1 |
| ● SS | K3202SS | 13,9 |
| ● BO | K3202BO | 13,3 |
| ● NP | K3202NP | 13,3 |
| ● II | K3202II | 16,7 |
| ● IS | K3202IS | 17,8 |
| ● RS | K3202RS | 16,7 |
| ● OO | K3202OO | 16,7 |

PACKAGING

L: 370 mm
D: 270 mm
H: 80 mm

2,7 kg

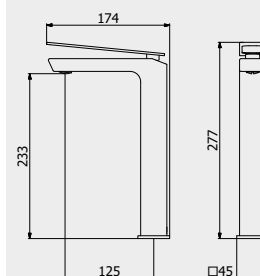

PORTATE | WATER FLOW | DÉBIT D'EAU

| | | |
|---------|---------|---------|
| 1 BAR | 2 BAR | 3 BAR |
| 3,6 l/m | 4,8 l/m | 5,2 l/m |



ARTICLE | ARTICOLO | ARTICLE

K3209



Monohole wall mounted washbasin mixer

Miscelatore lavabo a parete monoforo

Mitigeur lavabo mural monotrou



| CODICE / COEFFICIENTE CODE / COEFFICIENT | |
|--|--------------|
| CC | K3209CC 10,8 |
| SS | K3209SS 13,5 |
| BO | K3209BO 13,0 |
| NP | K3209NP 13,0 |
| II | K3209II 16,2 |
| IS | K3209IS 17,3 |
| RS | K3209RS 16,2 |
| OO | K3209OO 16,2 |

PACKAGING

L: 425 mm
D: 188 mm
H: 98 mm

3,5 kg

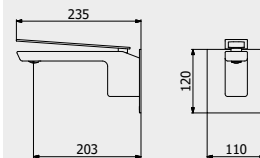

PORTATE | WATER FLOW | DÉBIT D'EAU

| 1 BAR | 2 BAR | 3 BAR |
|---------|-------|---------|
| 3,9 l/m | 5 l/m | 5,2 l/m |

K3

ARTICLE | ARTICOLO | ARTICLE

K3210



Ceiling spout with wall mounted mixer

Bocca da soffitto con comando remoto ad incasso

Mitigeur lavabo mural avec bec plafond complet avec bonde automatique

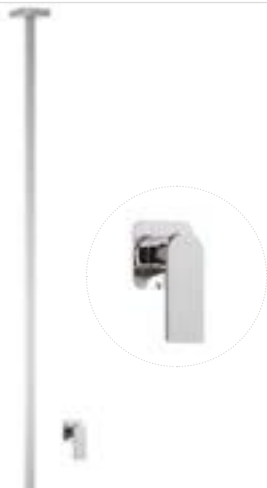

| CODICE / COEFFICIENTE CODE / COEFFICIENT | |
|--|---------------|
| CC | EK3210CC 33,8 |
| SS | EK3210SS 42,3 |
| BO | EK3210BO 40,6 |
| NP | EK3210NP 40,6 |

PACKAGING

L: 150 mm
D: 190 mm
H: 98 mm

L: 1700 mm
Ø: 70 mm

4,5 kg

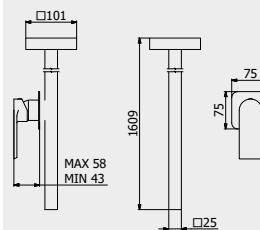

PORTATE | WATER FLOW | DÉBIT D'EAU

| 1 BAR | 2 BAR | 3 BAR |
|---------|---------|-------|
| 4,3 l/m | 5,2 l/m | 7 l/m |

Built-in body to be purchased separately

Corpo incasso da acquistare separatamente

Corps intégré à acheter séparément



CODICE | CODE | CODE

INC300XXXN_19

COEFFICIENTE | COEFFICIENT | COEFFICIENT

1,8

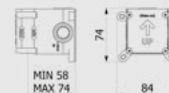

!

ARTICLE | ARTICOLO | ARTICLE

K3299



Monohole free-standing washbasin mixer complete with drain
 Miscelatore lavabo da terra completo di scarico automatico
 Mitigeur lavabo free standing complet avec bonde automatique

| CODICE / COEFFICIENTE CODE / COEFFICIENT | COEFFICIENT |
|--|-------------|
| CC EK3299CC | 30,7 |
| SS EK3299SS | 38,4 |
| BO EK3299BO | 36,8 |
| NP EK3299NP | 36,8 |
| II EK3299II | 46,1 |
| IS EK3299IS | 49,1 |
| RS EK3299RS | 46,1 |
| OO EK3299OO | 46,1 |

PACKAGING

L: 1160 mm
D: 360 mm
H: 180 mm

11,2 kg

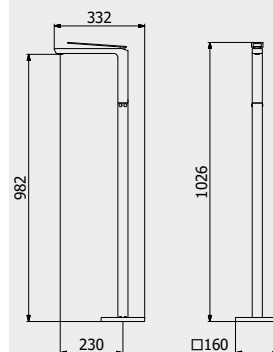

PORTATE | WATER FLOW | DÉBIT D'EAU

| 1 BAR | 2 BAR | 3 BAR |
|---------|---------|---------|
| 3,6 l/m | 5,1 l/m | 5,5 l/m |

Built-in body to be purchased separately
 AVAILABLE FROM JANUARY 2020

Corpo incasso da acquistare separatamente
 DISPONIBILE DA GENNAIO 2020
 Corps intégré à acheter séparément
 DISPONIBLE À PARTIR DE JANVIER 2020



CODICE | CODE | CODE

INC399XXXN_19

COEFFICIENTE | COEFFICIENT | COEFFICIENT

2,8

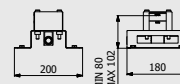

ARTICLE | ARTICOLO | ARTICLE

K3220



Monohole bidet mixer complete with drain
 Miscelatore bidet monoforo completo di scarico automatico
 Mitigeur bidet complet avec bonde automatique

| CODICE / COEFFICIENTE CODE / COEFFICIENT | COEFFICIENT |
|--|-------------|
| CC K3220CC | 6,6 |
| SS K3220SS | 8,3 |
| BO K3220BO | 7,9 |
| NP K3220NP | 7,9 |
| II K3220II | 9,9 |
| IS K3220IS | 10,6 |
| RS K3220RS | 9,9 |
| OO K3220OO | 9,8 |

PACKAGING

L: 340 mm
D: 180 mm
H: 70 mm

1,9 kg

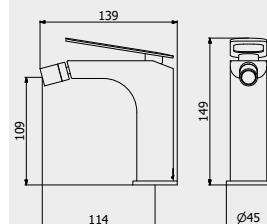

PORTATE | WATER FLOW | DÉBIT D'EAU

| 1 BAR | 2 BAR | 3 BAR |
|---------|---------|---------|
| 3,5 l/m | 4,9 l/m | 5,4 l/m |

ARTICLE | ARTICOLO | ARTICLE

K3300



Exposed parts for manual wall mixer
 Set di parti esterne per miscelatore a parete ad una via
 Partie extérieure pour mitigeur encastré à une voie

| CODICE / COEFFICIENTE CODE / COEFFICIENT | COEFFICIENT |
|--|-------------|
| CC EK3300CC | 4,1 |
| SS EK3300SS | 5,1 |
| BO EK3300BO | 4,9 |
| NP EK3300NP | 4,9 |
| II EK3300II | 6,2 |
| IS EK3300IS | 6,6 |
| RS EK3300RS | 6,2 |
| OO EK3300OO | 6,2 |

PACKAGING

L: 150 mm
D: 190 mm
H: 98 mm

1,8 kg

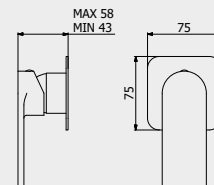

PORTATE | WATER FLOW | DÉBIT D'EAU

| 1 BAR | 2 BAR | 3 BAR |
|----------|----------|--------|
| 11,5 l/m | 16,3 l/m | 20 l/m |

Built-in body to be purchased separately

Corpo incasso da acquistare separatamente
 Corps intégré à acheter séparément



CODICE | CODE | CODE

INC300XXXN_19

COEFFICIENTE | COEFFICIENT | COEFFICIENT

1,8

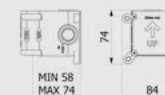

ARTICLE | ARTICOLO | ARTICLE

K3310



Exposed parts for manual wall mixer with two ways diverter
Miscelatore doccia a parete con deviatore due vie
Mitigeur douche mural deux voies avec inverseur

| CODICE / COEFFICIENTE CODE / COEFFICIENT | |
|--|--------------|
| CC | EK3310CC 6,1 |
| SS | EK3310SS 7,6 |
| BO | EK3310BO 7,3 |
| NP | EK3310NP 7,3 |
| II | EK3310II 9,2 |
| IS | EK3310IS 9,8 |
| RS | EK3310RS 9,2 |
| OO | EK3310OO 9,2 |

PACKAGING

L: 150 mm
D: 190 mm
H: 98 mm
1,8 kg

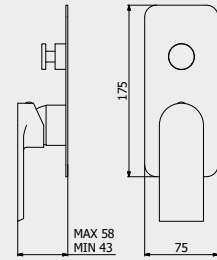

PORTATE | WATER FLOW | DÉBIT D'EAU

| 1 BAR | 2 BAR | 3 BAR |
|---------|----------|--------|
| 9,2 l/m | 12,5 l/m | 16 l/m |

Built-in body to be purchased separately
Corpo incasso da acquistare separatamente
Corps intégré à acheter séparément



CODICE | CODE | CODE

INC310XXXN_19

COEFFICIENTE | COEFFICIENT | COEFFICIENT

3,3

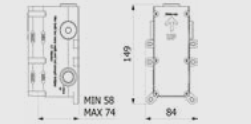

K3

ARTICLE | ARTICOLO | ARTICLE

K3312



Exposed parts for manual wall mixer with three ways diverter
Set di parti esterne per miscelatore a parete a tre vie
Mitigeur douche mural trois voies avec inverseur

| CODICE / COEFFICIENTE CODE / COEFFICIENT | |
|--|---------------|
| CC | EK3312CC 7,4 |
| SS | EK3312SS 9,3 |
| BO | EK3312BO 8,9 |
| NP | EK3312NP 8,9 |
| II | EK3312II 11,1 |
| IS | EK3312IS 11,8 |
| RS | EK3312RS 11,1 |
| OO | EK3312OO 11,1 |

PACKAGING

L: 150 mm
D: 190 mm
H: 98 mm
1,8 kg

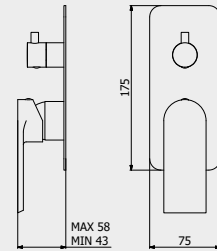

PORTATE | WATER FLOW | DÉBIT D'EAU

| 1 BAR | 2 BAR | 3 BAR |
|---------|----------|----------|
| 8,3 l/m | 11,7 l/m | 14,3 l/m |

Built-in body to be purchased separately
Corpo incasso da acquistare separatamente
Corps intégré à acheter séparément



CODICE | CODE | CODE

INC312XXXN_19

COEFFICIENTE | COEFFICIENT | COEFFICIENT

3,3

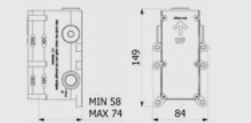

ARTICLE | ARTICOLO | ARTICLE

K3313



Exposed parts for manual wall mixer with 2 ways with shower kit
Set di parti esterne per miscelatore a parete a due vie completo di kit doccia
Partie extérieure pour mitigeur encastré à deux voies avec douchette

| CODICE / COEFFICIENTE CODE / COEFFICIENT | |
|--|---------------|
| CC | EK3313CC 10,1 |
| SS | EK3313SS 12,6 |
| BO | EK3313BO 12,1 |
| NP | EK3313NP 12,1 |
| II | EK3313II 15,2 |
| IS | EK3313IS 16,2 |
| RS | EK3313RS 15,2 |
| OO | EK3313OO 15,2 |

PACKAGING

L: 370 mm
D: 270 mm
H: 80 mm
2,2 kg

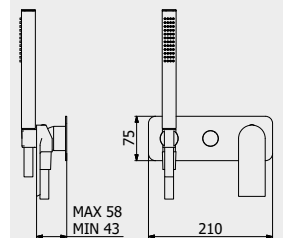

PORTATE | WATER FLOW | DÉBIT D'EAU

| 1 BAR | 2 BAR | 3 BAR |
|--------|----------|----------|
| 10 l/m | 14,1 l/m | 17,2 l/m |

Built-in body to be purchased separately
Corpo incasso da acquistare separatamente
Corps intégré à acheter séparément



CODICE | CODE | CODE

INC313XXXN_19

COEFFICIENTE | COEFFICIENT | COEFFICIENT

3,6

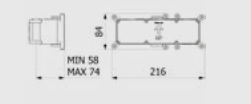

ARTICLE | ARTICOLO | ARTICLE

K3314



Exposed parts for manual wall mixer with 3 ways with shower kit
Set di parti esterne per miscelatore a parete a tre vie completo di kit doccia
Partie extérieure pour mitigeur encastré à trois voies avec douchette

| CODICE / COEFFICIENTE | CODE / COEFFICIENT | |
|-----------------------|--------------------|------|
| CC | EK3314CC | 11,4 |
| SS | EK3314SS | 14,3 |
| BO | EK3314BO | 13,7 |
| NP | EK3314NP | 13,7 |
| II | EK3314II | 17,1 |
| IS | EK3314IS | 18,2 |
| RS | EK3314RS | 17,1 |
| OO | EK3314OO | 17,1 |

PACKAGING

L: 370 mm
D: 270 mm
H: 80 mm

2,2 kg

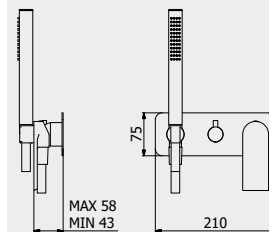

PORTATE | WATER FLOW | DÉBIT D'EAU

| | | |
|---------|----------|----------|
| 1 BAR | 2 BAR | 3 BAR |
| 8,3 l/m | 11,7 l/m | 14,3 l/m |

Built-in body to be purchased separately

Corpo incasso da acquistare separatamente

Corps intégré à acheter séparément



CODICE | CODE | CODE

INC314XXXN_19

COEFFICIENTE | COEFFICIENT | COEFFICIENT

3,7



ARTICLE | ARTICOLO | ARTICLE

K3350



Wall mounted shower mixer with shower kit

Doccia esterno a parete completo di kit doccia

Mitigeur de douche externe avec flexible et douchette

| CODICE / COEFFICIENTE | CODE / COEFFICIENT | |
|-----------------------|--------------------|------|
| CC | K3350CC | 11,1 |
| SS | K3350SS | 13,9 |
| BO | K3350BO | 13,3 |
| NP | K3350NP | 13,3 |
| II | K3350II | 16,7 |
| IS | K3350IS | 17,8 |
| RS | K3350RS | 16,7 |
| OO | K3350OO | 16,7 |

PACKAGING

L: 360 mm
D: 220 mm
H: 150 mm

3,5 kg

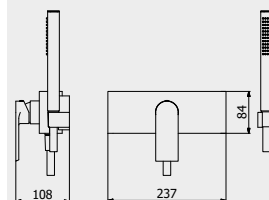

PORTATE | WATER FLOW | DÉBIT D'EAU

| | | |
|----------|----------|----------|
| 1 BAR | 2 BAR | 3 BAR |
| 11,5 l/m | 18,4 l/m | 23,3 l/m |

ARTICLE | ARTICOLO | ARTICLE

K3800



Shower column with mixer and shower kit

Colonna doccia con miscelatore e e kit doccia

Colonne de douche avec mitigeur et kit douche

| CODICE / COEFFICIENTE | CODE / COEFFICIENT | |
|-----------------------|--------------------|------|
| CC | K3800CC | 27,6 |

PACKAGING

L: 1200 mm
D: 400 mm
H: 170 mm

11,6 kg

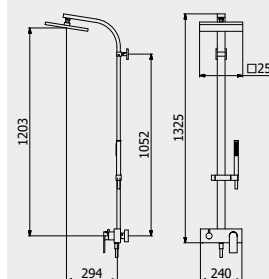

PORTATE | WATER FLOW | DÉBIT D'EAU

| | | |
|-------|--------|----------|
| 1 BAR | 2 BAR | 3 BAR |
| 9 l/m | 12 l/m | 14,5 l/m |



ARTICLE | ARTICOLO | ARTICLE

K3399



Free-standing bath filler with shower kit

Bordo vasca da terra con kit doccia

Bain douche complet alimentation au sol

| CODICE / COEFFICIENTE | CODE / COEFFICIENT | |
|-----------------------|--------------------|------|
| CC | EK3399CC | 41,0 |
| SS | EK3399SS | 51,3 |
| BO | EK3399BO | 49,2 |
| NP | EK3399NP | 49,2 |
| II | EK3399II | 61,5 |
| IS | EK3399IS | 65,6 |
| RS | EK3399RS | 61,5 |
| OO | EK3399OO | 61,5 |

PACKAGING

L: 1160 mm
D: 360 mm
H: 180 mm

14 kg

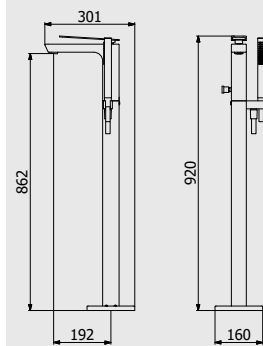

PORTATE | WATER FLOW | DÉBIT D'EAU

| 1 BAR | 2 BAR | 3 BAR |
|----------|----------|--------|
| 13,6 l/m | 19,6 l/m | 24 l/m |

K3

Built-in body to be purchased separately
AVAILABLE FROM JANUARY 2020
Corpo incasso da acquistare separatamente
DISPONIBILE DA GENNAIO 2020
Corps intégré à acheter séparément
DISPONIBLE À PARTIR DE JANVIER 2020



CODICE | CODE | CODE

INC399XXXN_19

COEFFICIENTE | COEFFICIENT | COEFFICIENT

2,8

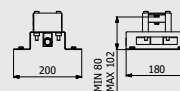

ARTICLE | ARTICOLO | ARTICLE

K3250



Wall mounted bath filler complete with hand shower kit

Bordo vasca esterno a parete completo di kit doccia

Mitigeur Bain/douche Mural avec douchette encastrée

| CODICE / COEFFICIENTE | CODE / COEFFICIENT | |
|-----------------------|--------------------|------|
| CC | K3250CC | 13,9 |
| SS | K3250SS | 17,4 |
| BO | K3250BO | 16,7 |
| NP | K3250NP | 16,7 |
| II | K3250II | 20,9 |
| IS | K3250IS | 20,9 |
| RS | K3250RS | 22,2 |
| OO | K3250OO | 20,9 |

PACKAGING

L: 353 mm
D: 225 mm
H: 226 mm

4,9 kg

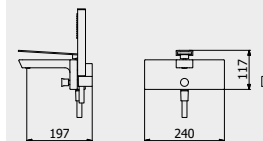

PORTATE | WATER FLOW | DÉBIT D'EAU

| 1 BAR | 2 BAR | 3 BAR |
|---------|----------|----------|
| 9,2 l/m | 14,2 l/m | 17,6 l/m |

ARTICLE | ARTICOLO | ARTICLE

RU319



Wall mounted waterfall

Cascata a parete con erogazione diretta

Cascade murale

| CODICE / COEFFICIENTE | CODE / COEFFICIENT | |
|-----------------------|--------------------|------|
| CC | RU319CC | 12,8 |
| SS | RU319SS | 16,0 |
| BO | RU319BO | 15,4 |
| NP | RU319NP | 15,4 |
| CF | RU319CF | 19,2 |
| CS | RU319CS | 20,5 |
| II | RU319II | 19,2 |
| IS | RU319IS | 20,5 |
| RS | RU319RS | 19,2 |
| SR | RU319SR | 20,5 |
| OO | RU319OO | 19,2 |
| OS | RU319OS | 20,5 |

PACKAGING

L: 340 mm
D: 180 mm
H: 70 mm

3,1 kg

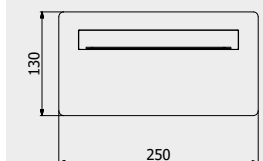

PORTATE | WATER FLOW | DÉBIT D'EAU

| 1 BAR | 2 BAR | 3 BAR |
|--------|--------|--------|
| 13 l/m | 17 l/m | 20 l/m |

ARTICLE | ARTICOLO | ARTICLE

RU320



Wall mounted spout

Bocca d'erogazione corta a parete

Bec de remplissage mural court

CODICE / COEFFICIENTE | CODE /
COEFFICIENT | CODE / COEFFICIENT

| | | |
|------|---------|-----|
| ● CC | RU320CC | 2,5 |
| ● SS | RU320SS | 3,1 |
| ● BO | RU320BO | 3,0 |
| ● NP | RU320NP | 3,0 |
| ● II | RU320II | 3,8 |
| ● IS | RU320IS | 4,0 |
| ● RS | RU320RS | 3,8 |
| ● OO | RU320OO | 3,8 |

PACKAGING

 L: 210 mm
D: 130 mm
H: 70 mm

1,5 kg

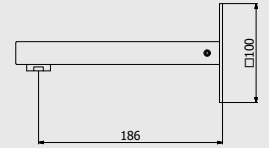

PORTATE | WATER FLOW | DÉBIT D'EAU

| | | |
|--------|--------|--------|
| 1 BAR | 2 BAR | 3 BAR |
| 15 l/m | 19 l/m | 24 l/m |

ARTICLE | ARTICOLO | ARTICLE

RU321



Short wall mounted spout

Bocca d'erogazione corta a parete

Bec de remplissage mural court

CODICE / COEFFICIENTE | CODE /
COEFFICIENT | CODE / COEFFICIENT

| | | |
|------|---------|-----|
| ● CC | RU321CC | 3,0 |
| ● SS | RU321SS | 3,8 |
| ● BO | RU321BO | 3,6 |
| ● NP | RU321NP | 3,6 |
| ● II | RU321II | 4,5 |
| ● IS | RU321IS | 4,8 |
| ● RS | RU321RS | 4,5 |
| ● OO | RU321OO | 4,5 |

PACKAGING

 L: 210 mm
D: 130 mm
H: 70 mm

1,4 kg

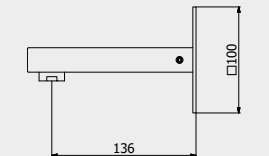

PORTATE | WATER FLOW | DÉBIT D'EAU

| | | |
|--------|--------|--------|
| 1 BAR | 2 BAR | 3 BAR |
| 15 l/m | 19 l/m | 24 l/m |

ARTICLE | ARTICOLO | ARTICLE

RU322



Long wall mounted spout

Bocca d'erogazione lunga a parete

Bec de remplissage mural long

CODICE / COEFFICIENTE | CODE /
COEFFICIENT | CODE / COEFFICIENT

| | | |
|------|---------|-----|
| ● CC | RU322CC | 3,0 |
| ● SS | RU322SS | 3,8 |
| ● BO | RU322BO | 3,6 |
| ● NP | RU322NP | 3,6 |
| ● II | RU322II | 4,5 |
| ● IS | RU322IS | 4,5 |
| ● RS | RU322RS | 4,8 |
| ● OO | RU322OO | 4,5 |

PACKAGING

 L: 210 mm
D: 130 mm
H: 70 mm

1,5 kg

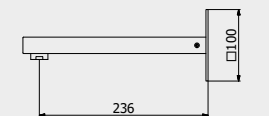

PORTATE | WATER FLOW | DÉBIT D'EAU

| | | |
|--------|--------|--------|
| 1 BAR | 2 BAR | 3 BAR |
| 15 l/m | 19 l/m | 24 l/m |



ARTICLE | ARTICOLO | ARTICLE

K3706



Exposed parts for bidet spray complete with mixer

Set di parti esterne per Idroscopino igienico con miscelatore

Partie extérieure pour douchette hygiénique avec mitigeur



| CODE / COEFFICIENT | CODICE / COEFFICIENTE | COEFFICIENT |
|--------------------|-----------------------|-------------|
| CC | EK3706CC | 9,8 |
| SS | EK3706SS | 12,3 |
| BO | EK3706BO | 11,8 |
| NP | EK3706NP | 11,8 |
| II | EK3706II | 14,7 |
| IS | EK3706IS | 15,7 |
| RS | EK3706RS | 14,7 |
| OO | EK3706OO | 14,7 |

PACKAGING

L: 370 mm
D: 270 mm
H: 80 mm

3,2 kg

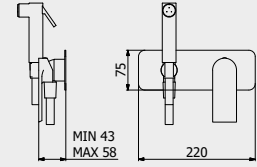

PORTATE | WATER FLOW | DÉBIT D'EAU

| 1 BAR | 2 BAR | 3 BAR |
|---------|---------|-------|
| 2,3 l/m | 3,2 l/m | 4 l/m |

K3

Built-in body to be purchased separately

Corpo incasso da acquistare separatamente

Corps intégré à acheter séparément



CODICE | CODE | CODE

INC206XXXN_19

COEFFICIENTE | COEFFICIENT | COEFFICIENT

2,9

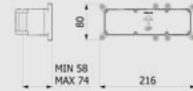

MODERNA / ACCESSORIES COLLECTION

ARTICLE | ARTICOLO | ARTICLE

MO001

Wall soap-holder

Porta sapone a muro

Porte distributeur de savon encastré

CODE / COEFFICIENT | CODICE /
COEFFICIENTE | CODE / COEFFICIENT

CC MO001CC 1,5

PACKAGING

L: 110 mm
 D: 130 mm
 H: 50 mm
 0,4 kg

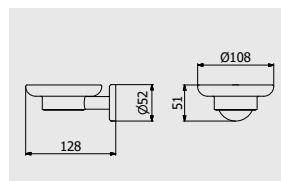

ARTICLE | ARTICOLO | ARTICLE

MO003

Wall toothbrush holder

Bicchieri porta spazzolino a parete

Porte-verre en verre gravé

CODE / COEFFICIENT | CODICE /
COEFFICIENTE | CODE / COEFFICIENT

CC MO003CC 1,5

PACKAGING

L: 70 mm
 D: 110 mm
 H: 100 mm
 0,4 kg

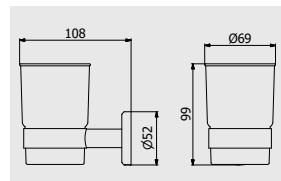

ARTICLE | ARTICOLO | ARTICLE

MO014

Towel holder

Porta salvietta

Porte-serviette

CODE / COEFFICIENT | CODICE /
COEFFICIENTE | CODE / COEFFICIENT

CC MO014CC 2,2

PACKAGING

L: 500 mm
 D: 70 mm
 H: 50 mm
 0,5 kg

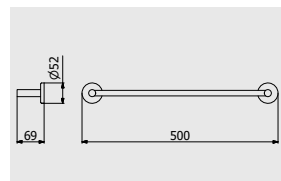

ARTICLE | ARTICOLO | ARTICLE

MO002

Wall soap dispenser holder

Porta dispenser sapone liquido a parete

Porte distributeur de savon en verre gravé

CODE / COEFFICIENT | CODICE /
COEFFICIENTE | CODE / COEFFICIENT

CC MO002CC 2,3

PACKAGING

L: 80 mm
 D: 130 mm
 H: 180 mm
 0,1 kg

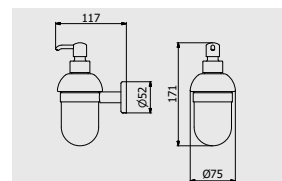

ARTICLE | ARTICOLO | ARTICLE

MO004

Towel holder

Porta salvietta

Porte-serviette

CODE / COEFFICIENT | CODICE /
COEFFICIENTE | CODE / COEFFICIENT

CC MO004CC 2,4

PACKAGING

L: 650 mm
 D: 70 mm
 H: 50 mm
 0,5 kg

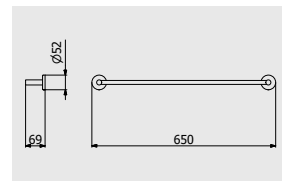

ARTICLE | ARTICOLO | ARTICLE

MO006

Towel holder

Porta salvietta

Porte-serviette

CODE / COEFFICIENT | CODICE /
COEFFICIENTE | CODE / COEFFICIENT

CC MO006CC 2,1

PACKAGING

L: 350 mm
 D: 70 mm
 H: 50 mm
 0,4 kg

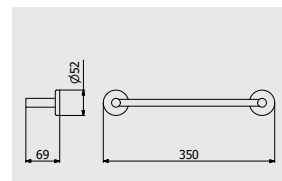

ARTICLE | ARTICOLO | ARTICLE

MO007

Ring Towel holder

Porta salvietta ad anello

Porte-serviettes anneau

CODE / COEFFICIENT | CODICE /
COEFFICIENTE | CODE / COEFFICIENT

CC MO007CC 1,6

PACKAGING

L: 180 mm 0,8 kg
D: 70 mm
H: 200 mm

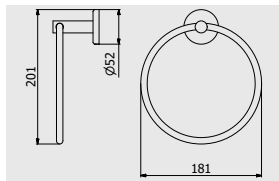

ARTICLE | ARTICOLO | ARTICLE

MO008

Robe Hook

Appendino a parete

Cintre

CODE / COEFFICIENT | CODICE /
COEFFICIENTE | CODE / COEFFICIENT

CC MO008CC 0,9

PACKAGING

L: 50 mm 0,3 kg
D: 50 mm
H: 50 mm

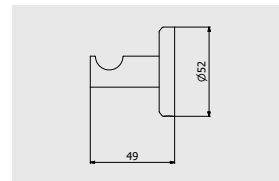

ARTICLE | ARTICOLO | ARTICLE

MO009

Double robe hook

Doppio appendino a parete

Double cintre

CODE / COEFFICIENT | CODICE /
COEFFICIENTE | CODE / COEFFICIENT

CC MO009CC 1,4

PACKAGING

L: 70 mm 0,1 kg
D: 70 mm
H: 50 mm

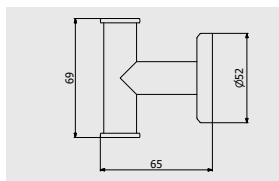

ARTICLE | ARTICOLO | ARTICLE

MO010

Shelf

Mensola

Etagère

CODE / COEFFICIENT | CODICE /
COEFFICIENTE | CODE / COEFFICIENT

CC MO010CC 3,0

PACKAGING

L: 600 mm 0,3 kg
D: 140 mm
H: 50 mm

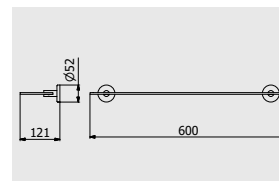

ARTICLE | ARTICOLO | ARTICLE

MO005

Swiveable towel holder

Porta salvietta doppio

Porte-serviettes noeud

CODE / COEFFICIENT | CODICE /
COEFFICIENTE | CODE / COEFFICIENT

CC MO005CC 3,5

PACKAGING

L: 430 mm 0,5 kg
D: 70 mm
H: 50 mm

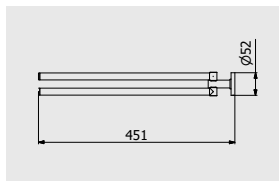

ARTICLE | ARTICOLO | ARTICLE

MO011

Toilet paper holder

Porta rotolo

Porte rouleaux de toilette

CODE / COEFFICIENT | CODICE /
COEFFICIENTE | CODE / COEFFICIENT

CC MO011CC 1,4

PACKAGING

L: 150 mm 0,2 kg
D: 70 mm
H: 50 mm

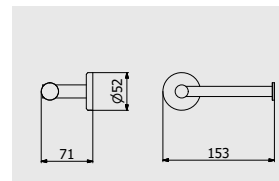

ARTICLE | ARTICOLO | ARTICLE

MO012

Toilet brush holder

Porta scopino da terra

Porte balayette au sol

CODE / COEFFICIENT | CODICE /
COEFFICIENTE | CODE / COEFFICIENT

CC MO012CC 2,5

PACKAGING

L: 80 mm 0,7 kg
D: 80 mm
H: 380 mm

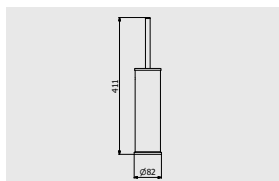

ARTICLE | ARTICOLO | ARTICLE

MO013

Wall toilet brush holder

Porta scopino da parete

Porte balayette

CODE / COEFFICIENT | CODICE /
COEFFICIENTE | CODE / COEFFICIENT

CC MO013CC 2,9

PACKAGING

L: 80 mm 0,7 kg
D: 80 mm
H: 380 mm

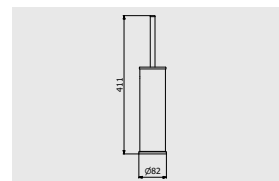

LOVEME

The spontaneous downpour of a small domestic waterfall.

Lo scrosciare spontaneo di una piccola cascata domestica.
Le crépitement spontané d'une petite cascade domestique.

To love means, first and foremost, to take care of oneself, starting from our daily home life. The LOVE ME collection enhances the free flow of water by replacing the directed jet with the spontaneous downpour of a small domestic waterfall. The water flows in a soft and natural outflow, like spouting directly from its source, thus combining aesthetic purity and genuine authenticity.

Amare significa anzitutto avere cura di sé, a partire dalla propria quotidianità casalinga. La serie LOVE ME esalta il flusso libero dell'acqua, sostituendo il getto direzionato con lo scrosciare spontaneo di una piccola cascata domestica. L'acqua scorre in un efflusso morbido e naturale, come sgorgando direttamente dalla sua fonte, coniugando così purezza estetica e genuina spontaneità.

Aimer, c'est d'abord prendre soin de soi-même, à partir de la vie quotidienne et domestique. La série LOVE ME glorifie le libre écoulement de l'eau en remplaçant le jet dirigé par le crépitement spontané d'une petite cascade domestique. L'eau s'écoule de manière douce et naturelle, comme si elle jaillissait directement de sa source, alliant ainsi pureté esthétique et spontanéité authentique.



LEAD FREE



ZINC FREE



CASCADE



Loveme



DESIGN
MAURIZIO DURANTI

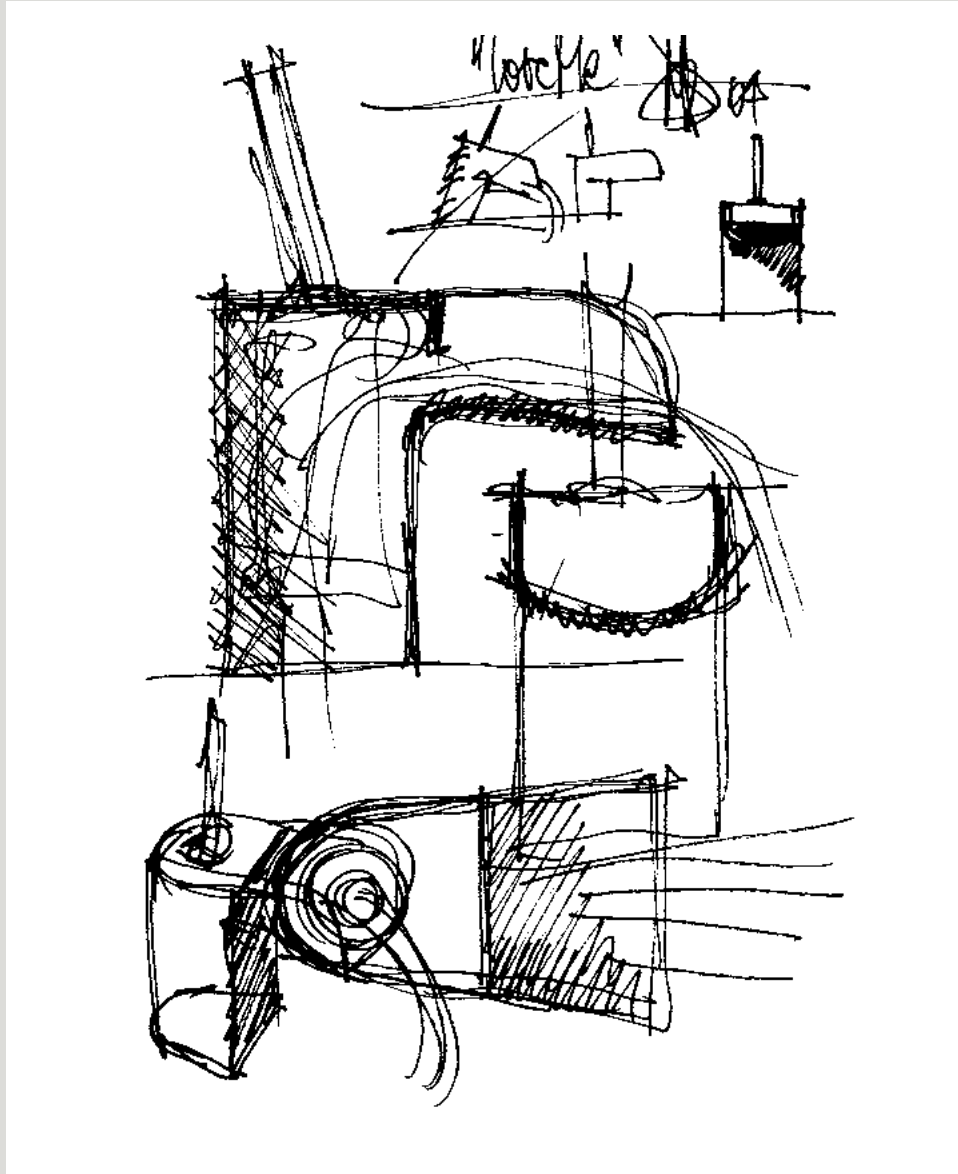

Self-care through the pleasure of a small waterfall, a synonym for life.

La cura di sé tramite il piacere di una piccola cascata d'acqua, sinonimo di vita.

Soin de soi, à travers le plaisir d'une petite cascade, synonyme de vie.

“ Loveme tell about my way of understanding design: narrative, simple, but also valuable and stimulating. Design must simultaneously create desires and satisfy functions. I find the English concept of “understatement” fascinating: the essence rather than the appearance, a low-key quality. Thus LOVE ME alludes to the more abstract concept of self-care through the pleasure of a small waterfall, a synonym for life. This collection, which is the one that gave me the biggest satisfaction and that gave birth to a new way of designing faucets. In hindsight, I think that LOVE ME is timeless.

Loveme racconta il mio modo di concepire il design: narrativo, semplice, ma anche prezioso e stimolante. Il design deve contemporaneamente creare desideri e soddisfare funzioni. Trovo affascinante il concetto inglese di “understatement”: l'essenza più che l'apparenza, il sottotono di qualità. Così LOVE ME allude a un concetto più astratto, la cura di sé tramite il piacere di una piccola cascata d'acqua, sinonimo di vita. Questa è la serie che mi ha dato più soddisfazioni e che ha dato vita a un nuovo modo di concepire i rubinetti. Con il senno del poi, penso che LOVE ME sia senza tempo.

Loveme raconte ma façon de concevoir le design: narratif, simple, mais aussi précieux et stimulant. Le design doit simultanément créer des désirs et satisfaire des fonctions. Je trouve fascinant le concept anglais de “understatement”: l'essence plutôt que l'aspect, le profil bas de qualité. Si LOVE ME fait allusion au concept plus abstrait du soin de soi, à travers le plaisir d'une petite cascade, synonyme de vie. C'est la série, celle qui m'a donné le plus de satisfaction et qui a créé une nouvelle façon de concevoir les robinets. Avec un peu de recul, je pense que LOVE ME est éternelle.

”

Maurizio Duranti design for LOVEME





Loveme

- ← LM200CC
Monohole washbasin mixer
Miscelatore lavabo monoforo
Mitigeur lavabo
- LM202CC
Tall monohole washbasin mixer
Miscelatore lavabo monoforo alto
Mitigeur lavabo haut
- ↘ LM200CC
Monohole washbasin mixer
Miscelatore lavabo monoforo
Mitigeur lavabo



- LM392CC
Three holes washbasin set with low spout
Lavabo tre fori a bocca bassa
Lavabo trois trous bec bas

- ↓ LM207CC
Wall mounted washbasin mixer with drain
Miscelatore lavabo due fori a parete
Mitigeur lavabo mural

- LM201CC
Mini monohole washbasin mixer
Miscelatore lavabo monoforo mini
Mitigeur lavabo Mini









← **LM314CC**
Three ways wall shower mixer complete with shower kit
Miscelatore doccia a parete con deviatore tre vie e doccino integrato
Mitigeur douche mural trois voies avec inverseur et douchette encastrée

↗ **LM350CC**
Wall mounted shower mixer with shower kit
Doccia esterno a parete di kit doccia
Mitigeur de douche externe avec flexible et douchette



- ← **LM750CC**
Deck mounted bath filler mixer
Miscelatore bordo vasca da appoggio
Mitigeur bain/douche
- ↓ **LM396CC**
Four holes deck mounted bath filler with shower kit
Bordo vasca quattro fori con deviatore e kit doccia
Bain/douche quatre trous avec inverseur et Kit Douche
- | | | | |
|----------|---|----------|---|
| A | Hot water Acqua calda Eau chaude | C | Cold water Acqua fredda Eau froide |
| B | Spout with diverter Bocca d'erogazione con deviatore Bec avec déviateur | D | Hand shower Doccino Douchette |
- **LM250CC**
Wall mounted bath filler complete with hand shower kit
Bordo vasca esterno a parete completo di kit doccia
Mitigeur bain/douche mural avec douchette encastrée



Loveme





↖ **LM250CC**
 Wall mounted bath filler complete with hand shower kit
 Bordo vasca esterno a parete completo di kit doccia
 Mitigeur bain/douche mural avec douchette encastrée

← **LM399CC**
 → Free-standing bath filler with shower kit
 Bordo vasca da terra con kit doccia
 Bain douche complet alimentation au sol

| | | | |
|----------|-----------------------------|----------|-----------------|
| A | Miscelatore joystick | C | Diverter |
| | Joystick mixer | | Deviatore |
| | Mélangeur de joystick | | Déviateur |
| B | Hand shower | | |
| | Doccino | | |
| | Douchette | | |



Loveme

ARTICLE | ARTICOLO | ARTICLE

LM200



Monohole washbasin mixer complete with drain

Miscelatore lavabo monoforo completo di scarico automatico

Mitigeur lavabo complet avec bonde automatique

CODE / COEFFICIENT | CODICE /
COEFFICIENTE | CODE / COEFFICIENT

| | | |
|------|---------|------|
| ● CC | LM200CC | 9,8 |
| ● SS | LM200SS | 12,3 |
| ● ON | LM200ON | 9,8 |
| ● BO | LM200BO | 11,8 |
| ● NP | LM200NP | 11,8 |
| ● CS | LM200CS | 14,7 |
| ● IS | LM200IS | 15,7 |
| ● SR | LM200SR | 15,7 |
| ● OS | LM200OS | 15,7 |

PACKAGING

 L: 240 mm
D: 215 mm
H: 110 mm

2,9 kg

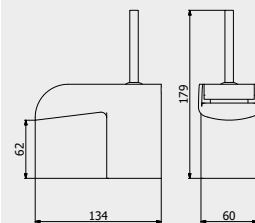

PORTATE | WATER FLOW | DÉBIT D'EAU

| | | |
|--------|----------|----------|
| 1 BAR | 2 BAR | 3 BAR |
| 10 l/m | 10,2 l/m | 10,5 l/m |

ARTICLE | ARTICOLO | ARTICLE

LM201



Mini monohole washbasin mixer complete with drain

Miscelatore lavabo monoforo mini completo di scarico automatico

Mitigeur lavabo mini complet avec bonde automatique

CODE / COEFFICIENT | CODICE /
COEFFICIENTE | CODE / COEFFICIENT

| | | |
|------|---------|-----|
| ● CC | LM201CC | 7,9 |
| ● SS | LM201SS | 9,9 |
| ● BO | LM201BO | 9,5 |
| ● NP | LM201NP | 9,5 |

PACKAGING

 L: 340 mm
D: 180 mm
H: 70 mm

1,6 kg

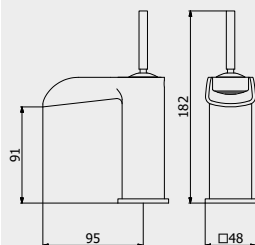

PORTATE | WATER FLOW | DÉBIT D'EAU

| | | |
|-------|-------|---------|
| 1 BAR | 2 BAR | 3 BAR |
| 7 l/m | 7 l/m | 7,5 l/m |

ARTICLE | ARTICOLO | ARTICLE

LM202



Tall monohole washbasin mixer complete with drain

Miscelatore lavabo monoforo alto completo di scarico automatico

Mitigeur lavabo haut complet avec bonde automatique

CODE / COEFFICIENT | CODICE /
COEFFICIENTE | CODE / COEFFICIENT

| | | |
|------|---------|------|
| ● CC | LM202CC | 17,6 |
| ● SS | LM202SS | 22,0 |
| ● ON | LM202ON | 17,6 |
| ● BO | LM202BO | 21,1 |
| ● NP | LM202NP | 21,1 |
| ● CS | LM202CS | 26,4 |
| ● IS | LM202IS | 28,2 |
| ● SR | LM202SR | 28,2 |
| ● OS | LM202OS | 28,2 |

PACKAGING

 L: 455 mm
D: 310 mm
H: 75 mm

4,4 kg

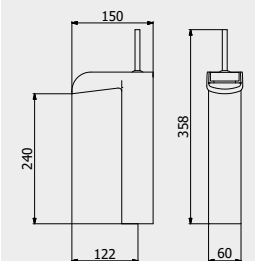

PORTATE | WATER FLOW | DÉBIT D'EAU

| | | |
|-------|-------|---------|
| 1 BAR | 2 BAR | 3 BAR |
| 8 l/m | 9 l/m | 9,5 l/m |

ARTICLE | ARTICOLO | ARTICLE

LM203



Tall mini monohole washbasin mixer complete with drain

Miscelatore lavabo monoforo alto mini completo di scarico automatico

Mitigeur lavabo haut mini complet avec bonde automatique

CODE / COEFFICIENT | CODICE /
COEFFICIENTE | CODE / COEFFICIENT

| | | |
|------|---------|------|
| ● CC | LM203CC | 11,7 |
| ● SS | LM203SS | 14,6 |
| ● BO | LM203BO | 14,0 |
| ● NP | LM203NP | 14,0 |

PACKAGING

 L: 425 mm
D: 188 mm
H: 98 mm

2,5 kg

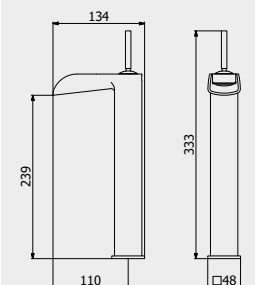

PORTATE | WATER FLOW | DÉBIT D'EAU

| | | |
|-------|-------|---------|
| 1 BAR | 2 BAR | 3 BAR |
| 7 l/m | 7 l/m | 7,5 l/m |



ARTICLE | ARTICOLO | ARTICLE

LM204



Mid-size monohole washbasin mixer complete with drain
 Miscelatore lavabo monoforo medio completo di scarico automatico
 Mitigeur lavabo moyen complet avec bonde automatique

| CODE / COEFFICIENT | CODICE / COEFFICIENTE | COEFFICIENT |
|--------------------|-----------------------|-------------|
| CC | LM204CC | 11,8 |
| SS | LM204SS | 14,8 |
| BO | LM204BO | 14,2 |
| NP | LM204NP | 14,2 |
| ON | LM204ON | 11,8 |

PACKAGING

L: 425 mm
 D: 188 mm
 H: 98 mm
 3,4 kg

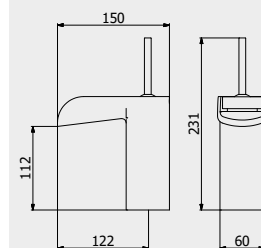

PORTATE | WATER FLOW | DÉBIT D'EAU

| 1 BAR | 2 BAR | 3 BAR |
|---------|---------|----------|
| 7,3 l/m | 8,9 l/m | 11,0 l/m |

Loveme

ARTICLE | ARTICOLO | ARTICLE

LM206



Wall mounted washbasin mixer complete with drain
 Miscelatore lavabo due fori a parete completo di scarico automatico
 Mitigeur lavabo mural complet avec bonde automatique

| CODE / COEFFICIENT | CODICE / COEFFICIENTE | COEFFICIENT |
|--------------------|-----------------------|-------------|
| CC | ELM206CC | 12,8 |
| SS | ELM206SS | 16,0 |
| ON | ELM206ON | 12,8 |
| BO | ELM206BO | 15,4 |
| NP | ELM206NP | 15,4 |
| CS | ELM206CS | 19,2 |
| IS | ELM206IS | 20,5 |
| SR | ELM206SR | 20,5 |
| OS | ELM206OS | 20,5 |

PACKAGING

L: 275 mm
 D: 270 mm
 H: 70 mm
 1,9 kg

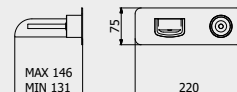

PORTATE | WATER FLOW | DÉBIT D'EAU

| 1 BAR | 2 BAR | 3 BAR |
|---------|-------|-------|
| 7,5 l/m | 8 l/m | 8 l/m |

Built-in body to be purchased separately
 Corpo incasso da acquistare separatamente
 Corps intégré à acheter séparément



CODICE | CODE | CODE

INC206XXXN_19

COEFFICIENTE | COEFFICIENT | COEFFICIENT

2,9



ARTICLE | ARTICOLO | ARTICLE

LM207



Wall mounted washbasin mixer with long spout complete with drain
 Miscelatore lavabo 2 fori a parete con bocca lunga completo di scarico automatico
 Mitigeur lavabo mural bec long complet avec bonde automatique

| CODE / COEFFICIENT | CODICE / COEFFICIENTE | COEFFICIENT |
|--------------------|-----------------------|-------------|
| CC | ELM207CC | 13,7 |
| SS | ELM207SS | 17,1 |
| ON | ELM207ON | 13,7 |
| BO | ELM207BO | 16,4 |
| NP | ELM207NP | 16,4 |
| CS | ELM207CS | 20,6 |
| IS | ELM207IS | 21,9 |
| SR | ELM207SR | 21,9 |
| OS | ELM207OS | 21,9 |

PACKAGING

L: 275 mm
 D: 270 mm
 H: 70 mm
 1,9 kg

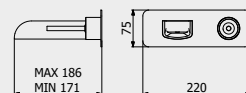

PORTATE | WATER FLOW | DÉBIT D'EAU

| 1 BAR | 2 BAR | 3 BAR |
|---------|-------|-------|
| 7,5 l/m | 8 l/m | 8 l/m |

Built-in body to be purchased separately
 Corpo incasso da acquistare separatamente
 Corps intégré à acheter séparément



CODICE | CODE | CODE

INC206XXXN_19

COEFFICIENTE | COEFFICIENT | COEFFICIENT

2,9



ARTICLE | ARTICOLO | ARTICLE

LM210

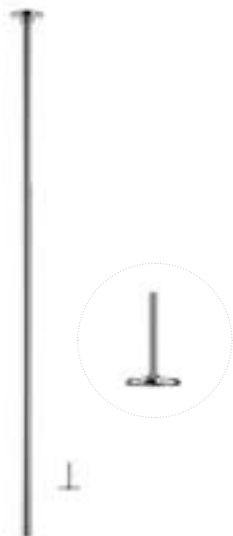

Ceiling spout with wall mounted mixer

Bocca da soffitto con comando remoto ad incasso

Mitigeur lavabo mural avec bec plafond complet avec bonde automatique

| CODE / COEFFICIENT | CODICE / COEFFICIENTE | |
|--------------------|-----------------------|------|
| CC | ELM210CC | 27,5 |
| SS | ELM210SS | 34,4 |
| BO | ELM210BO | 33,0 |
| NP | ELM210NP | 33,0 |
| ON | ELM210ON | 27,5 |

PACKAGING

L: 150 mm
D: 190 mm
H: 98 mm

L: 1700 mm
Ø: 70 mm

4,5 kg

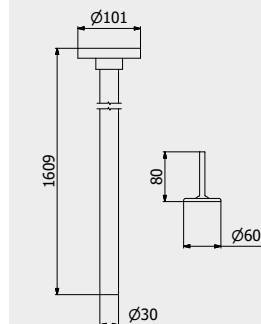

PORTATE | WATER FLOW | DÉBIT D'EAU

| | | |
|---------|---------|-------|
| 1 BAR | 2 BAR | 3 BAR |
| 4,3 l/m | 5,2 l/m | 7 l/m |

ARTICLE | ARTICOLO | ARTICLE

LM392



Three holes washbasin set with low spout

Lavabo tre fori a bocca bassa completo di scarico automatico

Lavabo trois trous bec bas

| CODE / COEFFICIENT | CODICE / COEFFICIENTE | |
|--------------------|-----------------------|------|
| CC | LM392CC | 14,5 |
| SS | LM392SS | 18,1 |
| BO | LM392BO | 17,4 |
| NP | LM392NP | 17,4 |
| ON | LM392ON | 14,5 |

PACKAGING

L: 425 mm
D: 188 mm
H: 98 mm

3,9 kg

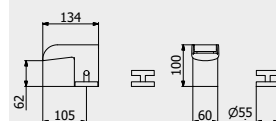

PORTATE | WATER FLOW | DÉBIT D'EAU

| | | |
|--------|----------|--------|
| 1 BAR | 2 BAR | 3 BAR |
| 10 l/m | 10,5 l/m | 11 l/m |

ARTICLE | ARTICOLO | ARTICLE

LM220



Monohole bidet mixer complete with drain

Miscelatore bidet monoforo completo di scarico automatico

Mitigeur bidet complet avec bonde automatique

| CODE / COEFFICIENT | CODICE / COEFFICIENTE | |
|--------------------|-----------------------|------|
| CC | LM220CC | 9,8 |
| SS | LM220SS | 12,3 |
| ON | LM220ON | 9,8 |
| BO | LM220BO | 11,8 |
| NP | LM220NP | 11,8 |
| CS | LM220CS | 14,7 |
| IS | LM220IS | 15,7 |
| SR | LM220SR | 15,7 |
| OS | LM220OS | 15,7 |

PACKAGING

L: 240 mm
D: 215 mm
H: 110 mm

2,0 kg

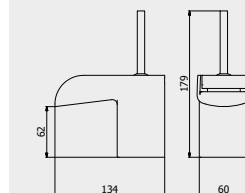

PORTATE | WATER FLOW | DÉBIT D'EAU

| | | |
|--------|----------|----------|
| 1 BAR | 2 BAR | 3 BAR |
| 10 l/m | 10,2 l/m | 10,5 l/m |



ARTICLE | ARTICOLO | ARTICLE

LM223



Mini monohole bidet mixer complete with drain
 Miscelatore bidet monoforo mini completo di scarico automatico
 Mitigeur bidet mini complet avec bonde automatique

| CODE / COEFFICIENT CODICE / COEFFICIENTE CODE / COEFFICIENT | |
|---|-----|
| CC LM223CC | 7,9 |
| SS LM223SS | 9,9 |
| BO LM223BO | 9,5 |
| NP LM223NP | 9,5 |

PACKAGING

L: 455 mm
 D: 310 mm
 H: 75 mm
 2,5 kg

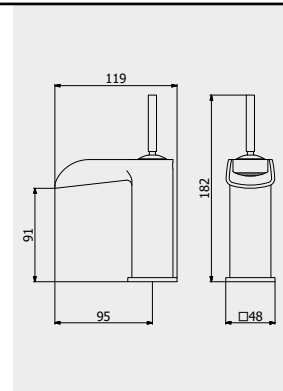

PORTATE | WATER FLOW | DÉBIT D'EAU

| 1 BAR | 2 BAR | 3 BAR |
|-------|-------|---------|
| 7 l/m | 7 l/m | 7,2 l/m |

Loveme

ARTICLE | ARTICOLO | ARTICLE

LM393



Three holes bidet set
 Bidet tre fori con bocca snodabile completo di scarico automatico
 Bidet trois trous

| CODE / COEFFICIENT CODICE / COEFFICIENTE CODE / COEFFICIENT | |
|---|------|
| CC LM393CC | 14,5 |
| SS LM393SS | 18,1 |
| BO LM393BO | 17,4 |
| NP LM393NP | 17,4 |
| ON LM393ON | 14,5 |

PACKAGING

L: 425 mm
 D: 188 mm
 H: 98 mm
 3,9 kg

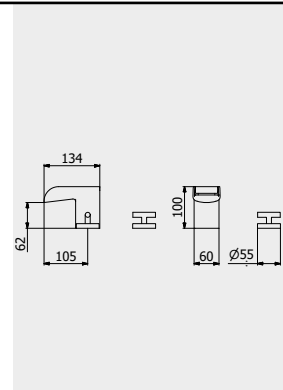

PORTATE | WATER FLOW | DÉBIT D'EAU

| 1 BAR | 2 BAR | 3 BAR |
|--------|----------|--------|
| 10 l/m | 10,5 l/m | 11 l/m |

ARTICLE | ARTICOLO | ARTICLE

LM300



Exposed parts for manual wall mixer
 Set di parti esterne per miscelatore a parete ad una via
 Partie extérieure pour mitigeur encastré à une voie

| CODE / COEFFICIENT CODICE / COEFFICIENTE CODE / COEFFICIENT | |
|---|-----|
| CC ELM300CC | 4,1 |
| SS ELM300SS | 5,1 |
| ON ELM300ON | 4,1 |
| BO ELM300BO | 4,9 |
| NP ELM300NP | 4,9 |
| CS ELM300CS | 6,2 |
| IS ELM300IS | 6,6 |
| SR ELM300SR | 6,6 |
| OS ELM300OS | 6,6 |

PACKAGING

L: 150 mm
 D: 190 mm
 H: 98 mm
 1,9 kg

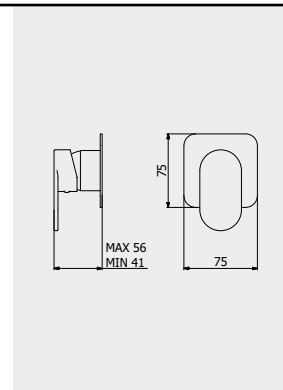

PORTATE | WATER FLOW | DÉBIT D'EAU

| 1 BAR | 2 BAR | 3 BAR |
|----------|----------|--------|
| 11,5 l/m | 16,3 l/m | 20 l/m |

Built-in body to be purchased separately
 Corpo incasso da acquistare separatamente
 Corps intégré à acheter séparément



CODICE | CODE | CODE

INC300XXXN_19

COEFFICIENTE | COEFFICIENT | COEFFICIENT

1,8

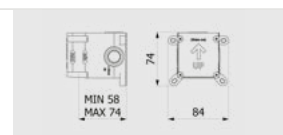

ARTICLE | ARTICOLO | ARTICLE

LM310



Exposed parts for manual wall mixer with two ways diverter
Miscelatore doccia a parete con deviatore due vie
Mitigeur douche mural deux voies avec inverseur

| CODE / COEFFICIENT | CODICE / COEFFICIENTE | COEFFICIENT |
|--------------------|-----------------------|-------------|
| CC | ELM310CC | 6,1 |
| SS | ELM310SS | 7,6 |
| ON | ELM310ON | 6,1 |
| BO | ELM310BO | 7,3 |
| NP | ELM310NP | 7,3 |
| CS | ELM310CS | 9,2 |
| IS | ELM310IS | 9,8 |
| SR | ELM310SR | 9,8 |
| OS | ELM310OS | 9,8 |

PACKAGING

L: 150 mm
D: 190 mm
H: 98 mm

1,9 kg

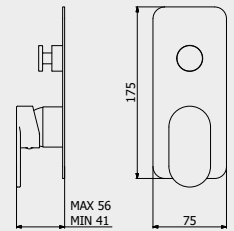

PORTATE | WATER FLOW | DÉBIT D'EAU

| | | |
|---------|----------|--------|
| 1 BAR | 2 BAR | 3 BAR |
| 9,2 l/m | 12,8 l/m | 16 l/m |

Built-in body to be purchased separately

Corpo incasso da acquistare separatamente

Corps intégré à acheter séparément



CODICE | CODE | CODE

INC310XXXN_19

COEFFICIENTE | COEFFICIENT | COEFFICIENT

3,3

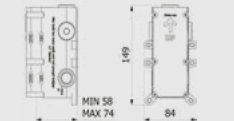

ARTICLE | ARTICOLO | ARTICLE

LM312



Exposed parts for manual wall mixer with three ways diverter
Set di parti esterne per miscelatore a parete a tre vie
Mitigeur douche mural trois voies avec inverseur

| CODE / COEFFICIENT | CODICE / COEFFICIENTE | COEFFICIENT |
|--------------------|-----------------------|-------------|
| CC | ELM312CC | 7,4 |
| SS | ELM312SS | 9,3 |
| ON | ELM312ON | 7,4 |
| BO | ELM312BO | 8,9 |
| NP | ELM312NP | 8,9 |
| CS | ELM312CS | 11,1 |
| IS | ELM312IS | 11,8 |
| SR | ELM312SR | 11,8 |
| OS | ELM312OS | 11,8 |

PACKAGING

L: 150 mm
D: 190 mm
H: 98 mm

1,9 kg

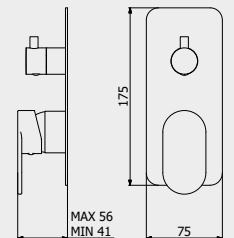

PORTATE | WATER FLOW | DÉBIT D'EAU

| | | |
|---------|----------|----------|
| 1 BAR | 2 BAR | 3 BAR |
| 8,3 l/m | 11,7 l/m | 14,3 l/m |

Built-in body to be purchased separately

Corpo incasso da acquistare separatamente

Corps intégré à acheter séparément



CODICE | CODE | CODE

INC312XXXN_19

COEFFICIENTE | COEFFICIENT | COEFFICIENT

3,3

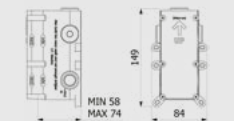

ARTICLE | ARTICOLO | ARTICLE

LM313



Exposed parts for manual wall mixer with 2 ways with shower kit
Set di parti esterne per miscelatore a parete a due vie completo di kit doccia
Partie extérieure pour mitigeur encastré à deux voies avec douchette

| CODE / COEFFICIENT | CODICE / COEFFICIENTE | COEFFICIENT |
|--------------------|-----------------------|-------------|
| CC | ELM313CC | 10,1 |
| SS | ELM313SS | 12,6 |
| ON | ELM313ON | 10,1 |
| BO | ELM313BO | 12,1 |
| NP | ELM313NP | 12,1 |
| CS | ELM313CS | 15,2 |
| IS | ELM313IS | 16,2 |
| SR | ELM313SR | 16,2 |
| OS | ELM313OS | 16,2 |

PACKAGING

L: 370 mm
D: 270 mm
H: 80 mm

2,2 kg

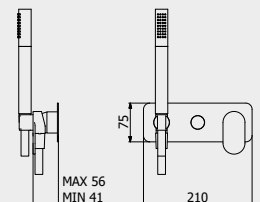

PORTATE | WATER FLOW | DÉBIT D'EAU

| | | |
|--------|----------|----------|
| 1 BAR | 2 BAR | 3 BAR |
| 10 l/m | 14,1 l/m | 17,2 l/m |

Built-in body to be purchased separately

Corpo incasso da acquistare separatamente

Corps intégré à acheter séparément



CODICE | CODE | CODE

INC313XXXN_19

COEFFICIENTE | COEFFICIENT | COEFFICIENT

3,6



ARTICLE | ARTICOLO | ARTICLE

LM314



Exposed parts for manual wall mixer with 3 ways with shower kit
Set di parti esterne per miscelatore a parete a tre vie completo di kit doccia
Partie extérieure pour mitigeur encastré à trois voies avec douchette

| CODE / COEFFICIENT | CODICE / COEFFICIENTE | COEFFICIENT |
|--------------------|-----------------------|-------------|
| CC | ELM314CC | 11,4 |
| SS | ELM314SS | 14,3 |
| ON | ELM314ON | 11,4 |
| BO | ELM314BO | 13,7 |
| NP | ELM314NP | 13,7 |
| CS | ELM314CS | 17,1 |
| IS | ELM314IS | 18,2 |
| SR | ELM314SR | 18,2 |
| OS | ELM314OS | 18,2 |

PACKAGING
L: 370 mm
D: 270 mm
H: 80 mm
2,2 kg

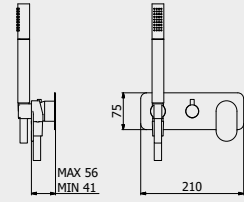

PORTATE | WATER FLOW | DÉBIT D'EAU

| 1 BAR | 2 BAR | 3 BAR |
|---------|----------|----------|
| 8,3 l/m | 11,7 l/m | 14,3 l/m |

Loveme

Built-in body to be purchased separately

Corpo incasso da acquistare separatamente
Corps intégré à acheter séparément



CODICE | CODE | CODE

INC314XXXN_19

COEFFICIENTE | COEFFICIENT | COEFFICIENT
3,7



ARTICLE | ARTICOLO | ARTICLE

RU318



Built-in wall mounted waterfall spout
Cascata a parete con erogazione a lama esterna
Cascade murale avec bec externe

| CODE / COEFFICIENT | CODICE / COEFFICIENTE | COEFFICIENT |
|--------------------|-----------------------|-------------|
| CC | RU318CC | 22,9 |
| SS | RU318SS | 28,6 |
| BO | RU318BO | 27,5 |
| NP | RU318NP | 27,5 |
| CF | RU318CF | 34,4 |
| CS | RU318CS | 36,6 |
| II | RU318II | 34,4 |
| IS | RU318IS | 36,6 |
| RS | RU318RS | 34,4 |
| SR | RU318SR | 36,6 |
| OO | RU318OO | 34,4 |
| OS | RU318OS | 36,6 |

PACKAGING
L: 340 mm
D: 180 mm
H: 70 mm
4,0 kg

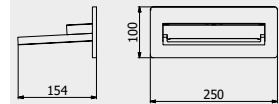

PORTATE | WATER FLOW | DÉBIT D'EAU

| 1 BAR | 2 BAR | 3 BAR |
|--------|----------|--------|
| 13 l/m | 17,7 l/m | 20 l/m |

ARTICLE | ARTICOLO | ARTICLE

RU319



Wall mounted waterfall
Cascata a parete con erogazione diretta
Cascade murale

| CODE / COEFFICIENT | CODICE / COEFFICIENTE | COEFFICIENT |
|--------------------|-----------------------|-------------|
| CC | RU319CC | 12,8 |
| SS | RU319SS | 16,0 |
| BO | RU319BO | 15,4 |
| NP | RU319NP | 15,4 |
| CF | RU319CF | 19,2 |
| CS | RU319CS | 20,5 |
| II | RU319II | 19,2 |
| IS | RU319IS | 20,5 |
| RS | RU319RS | 19,2 |
| SR | RU319SR | 20,5 |
| OO | RU319OO | 19,2 |
| OS | RU319OS | 20,5 |

PACKAGING
L: 340 mm
D: 180 mm
H: 70 mm
3,1 kg

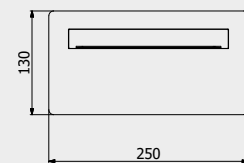

PORTATE | WATER FLOW | DÉBIT D'EAU

| 1 BAR | 2 BAR | 3 BAR |
|--------|----------|--------|
| 13 l/m | 17,7 l/m | 20 l/m |

ARTICLE | ARTICOLO | ARTICLE

LM320



Wall mounted spout
Bocca d'erogazione a parete
Bec de remplissage mural

CODE / COEFFICIENT | CODICE /
COEFFICIENTE | CODE / COEFFICIENT

| | | |
|------|---------|------|
| ● CC | LM320CC | 8,7 |
| ● SS | LM320SS | 10,8 |
| ● BO | LM320BO | 10,3 |
| ● NP | LM320NP | 10,3 |
| ● ON | LM320ON | 8,7 |

PACKAGING

L: 175 mm
D: 125 mm
H: 90 mm

1,8 kg

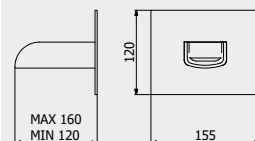

PORTATE | WATER FLOW | DÉBIT D'EAU

| | | |
|---------|-------|-------|
| 1 BAR | 2 BAR | 3 BAR |
| 6,5 l/m | 8 l/m | 8 l/m |

ARTICLE | ARTICOLO | ARTICLE

LM322



Long wall mounted spout
Bocca d'erogazione lunga a parete
Bec de remplissage mural long

CODE / COEFFICIENT | CODICE /
COEFFICIENTE | CODE / COEFFICIENT

| | | |
|------|---------|------|
| ● CC | LM322CC | 9,3 |
| ● SS | LM322SS | 11,7 |
| ● BO | LM322BO | 11,2 |
| ● NP | LM322NP | 11,2 |
| ● ON | LM322ON | 9,3 |

PACKAGING

L: 175 mm
D: 125 mm
H: 90 mm

1,9 kg

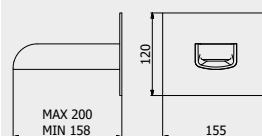

PORTATE | WATER FLOW | DÉBIT D'EAU

| | | |
|---------|-------|-------|
| 1 BAR | 2 BAR | 3 BAR |
| 6,5 l/m | 8 l/m | 8 l/m |

ARTICLE | ARTICOLO | ARTICLE

LM350



Wall mounted shower mixer with shower kit
Doccia esterno a parete completo di kit doccia
Mitigeur de douche externe avec flexible et douchette

CODE / COEFFICIENT | CODICE /
COEFFICIENTE | CODE / COEFFICIENT

| | | |
|------|---------|------|
| ● CC | LM350CC | 17,3 |
| ● SS | LM350SS | 20,4 |
| ● BO | LM350BO | 19,7 |
| ● NP | LM350NP | 19,7 |
| ● ON | LM350ON | 17,3 |

PACKAGING

L: 370 mm
D: 220 mm
H: 150 mm

5,1 kg

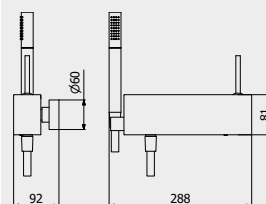

PORTATE | WATER FLOW | DÉBIT D'EAU

| | | |
|----------|----------|----------|
| 1 BAR | 2 BAR | 3 BAR |
| 12,4 l/m | 17,7 l/m | 22,0 l/m |

ARTICLE | ARTICOLO | ARTICLE

LM250



Wall mounted bath filler complete with hand shower kit
Bordo vasca esterno a parete completo di kit doccia
Mitigeur Bain/douche Mural avec douchette encastrée

CODE / COEFFICIENT | CODICE /
COEFFICIENTE | CODE / COEFFICIENT

| | | |
|------|---------|------|
| ● CC | LM250CC | 22,3 |
| ● SS | LM250SS | 27,9 |
| ● BO | LM250BO | 26,8 |
| ● NP | LM250NP | 26,8 |
| ● ON | LM250ON | 22,3 |

PACKAGING

L: 370 mm
D: 220 mm
H: 150 mm

7,1 kg

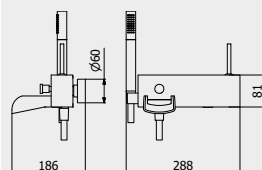

PORTATE | WATER FLOW | DÉBIT D'EAU

| | | |
|----------|----------|----------|
| 1 BAR | 2 BAR | 3 BAR |
| 10,0 l/m | 14,3 l/m | 18,0 l/m |



ARTICLE | ARTICOLO | ARTICLE

LM740



Two holes deck mounted bath filler mixer with shower kit
 Miscelatore bordo vasca da appoggio due fori con doccino
 Mitigeur bain deux trous avec douchette

| CODE / COEFFICIENT | CODICE / COEFFICIENTE | |
|--------------------|-----------------------|------|
| CC | LM740CC | 25,0 |
| SS | LM740SS | 31,3 |
| BO | LM740BO | 30,0 |
| NP | LM740NP | 30,0 |

PACKAGING

L: 370 mm
 D: 220 mm
 H: 250 mm
 5,9 kg

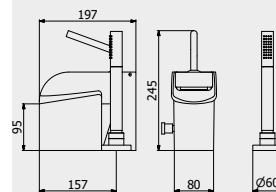

PORTATE | WATER FLOW | DÉBIT D'EAU

| 1 BAR | 2 BAR | 3 BAR |
|----------|--------|----------|
| 22,3 l/m | 32 l/m | 39,4 l/m |

Loveme

ARTICLE | ARTICOLO | ARTICLE

LM750



Monohole deck mounted bath filler mixer
 Miscelatore bordo vasca da appoggio
 Mitigeur bain

| CODE / COEFFICIENT | CODICE / COEFFICIENTE | |
|--------------------|-----------------------|------|
| CC | LM750CC | 23,4 |
| SS | LM750SS | 29,3 |
| BO | LM750BO | 28,1 |
| NP | LM750NP | 28,1 |

PACKAGING

L: 370 mm
 D: 220 mm
 H: 250 mm
 4,9 kg

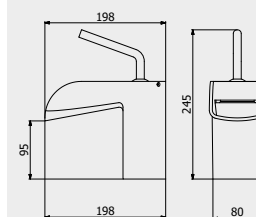

PORTATE | WATER FLOW | DÉBIT D'EAU

| 1 BAR | 2 BAR | 3 BAR |
|----------|--------|----------|
| 22,3 l/m | 32 l/m | 39,4 l/m |

ARTICLE | ARTICOLO | ARTICLE

LM396



Four holes deck mounted bath filler with shower kit
 Bordo vasca quattro fori con deviatore e kit doccia
 Bain/douche quatre trous avec inverseur et Kit douche

| CODE / COEFFICIENT | CODICE / COEFFICIENTE | |
|--------------------|-----------------------|------|
| CC | LM396CC | 21,5 |
| SS | LM396SS | 27,9 |
| BO | LM396BO | 25,8 |
| NP | LM396NP | 25,8 |
| ON | LM396ON | 21,5 |

PACKAGING

L: 425 mm
 D: 188 mm
 H: 98 mm
 5,7 kg

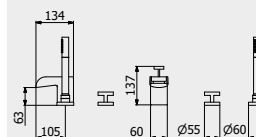

PORTATE | WATER FLOW | DÉBIT D'EAU

| 1 BAR | 2 BAR | 3 BAR |
|----------|----------|----------|
| 12,8 l/m | 15,9 l/m | 18,3 l/m |

ARTICLE | ARTICOLO | ARTICLE

LM397



4 holes bath filler with overflow outlet connection, diverter and shower kit
Bordo vasca 4 fori per colonna riempimento con deviatore e kit doccia
Bain/douche 4 trous avec inverseur et Kit Douche pour remplissage ETP

| CODE / COEFFICIENT | CODICE / COEFFICIENTE | |
|--------------------|-----------------------|------|
| CC | LM397CC | 14,2 |
| SS | LM397SS | 17,8 |
| BO | LM397BO | 17,0 |
| NP | LM397NP | 17,0 |
| ON | LM397ON | 14,2 |

PACKAGING

| | |
|--|-----------|
| | L: 425 mm |
| | D: 188 mm |
| | H: 98 mm |
| | 4,5 kg |

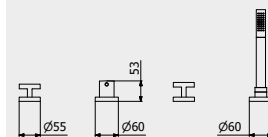

PORTATE | WATER FLOW | DÉBIT D'EAU

| | | |
|--------|--------|--------|
| 1 BAR | 2 BAR | 3 BAR |
| 19 l/m | 27 l/m | 33 l/m |

ARTICLE | ARTICOLO | ARTICLE

LM399



Free-standing bath filler with shower kit
Bordo vasca da terra con kit doccia
Bain douche complet alimentation au sol

| CODE / COEFFICIENT | CODICE / COEFFICIENTE | |
|--------------------|-----------------------|------|
| CC | ELM399CC | 44,7 |
| SS | ELM399SS | 55,9 |
| BO | ELM399BO | 53,7 |
| NP | ELM399NP | 53,7 |
| ON | ELM399ON | 44,7 |

PACKAGING

| | |
|--|------------|
| | L: 1100 mm |
| | D: 400 mm |
| | H: 170 mm |
| | 15,2 kg |

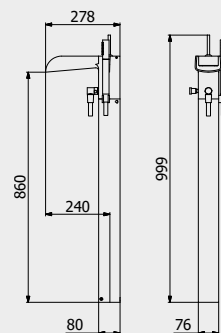

PORTATE | WATER FLOW | DÉBIT D'EAU

| | | |
|--------|--------|--------|
| 1 BAR | 2 BAR | 3 BAR |
| 17 l/m | 22 l/m | 28 l/m |

ARTICLE | ARTICOLO | ARTICLE

LM706



Exposed parts for bidet spray complete with mixer
Set di parti esterne per Idroscopino igienico con miscelatore
Partie extérieure pour douchette hygiénique avec mitigeur

| CODE / COEFFICIENT | CODICE / COEFFICIENTE | |
|--------------------|-----------------------|------|
| CC | ELM706CC | 9,8 |
| SS | ELM706SS | 12,3 |
| ON | ELM706ON | 9,8 |
| BO | ELM706BO | 11,8 |
| NP | ELM706NP | 11,8 |
| CS | ELM706CS | 14,7 |
| IS | ELM706IS | 15,7 |
| SR | ELM706SR | 15,7 |
| OS | ELM706OS | 15,7 |

PACKAGING

| | |
|--|-----------|
| | L: 370 mm |
| | D: 270 mm |
| | H: 80 mm |
| | 3,2 kg |

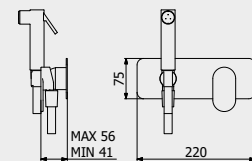

PORTATE | WATER FLOW | DÉBIT D'EAU

| | | |
|---------|---------|-------|
| 1 BAR | 2 BAR | 3 BAR |
| 2,3 l/m | 3,2 l/m | 4 l/m |

Built-in body to be purchased separately

Corpo incasso da acquistare separatamente

Corps intégré à acheter séparément



CODICE | CODE | CODE

INC206XXXN_19

COEFFICIENTE | COEFFICIENT | COEFFICIENT

2,9



SNATCH / ACCESSORIES COLLECTION

Loveme

ARTICLE | ARTICOLO | ARTICLE

HJ001



Wall soap-holder
Porta sapone a muro
Porte distributeur de savon encastré

**CODICE / COEFFICIENTE | CODE /
COEFFICIENT | CODE / COEFFICIENT**

| | | |
|----|---------|-----|
| CC | HJ001CC | 5,5 |
| SS | HJ001SS | 5,7 |
| BO | HJ001BO | 5,7 |
| NP | HJ001NP | 5,7 |
| CF | HJ001CF | 5,7 |
| CS | HJ001CS | 5,7 |
| II | HJ001II | 5,7 |
| IS | HJ001IS | 5,7 |
| RS | HJ001RS | 5,7 |
| SR | HJ001SR | 5,7 |
| OO | HJ001OO | 5,7 |
| OS | HJ001OS | 5,7 |

PACKAGING

| | | | |
|--|------------------------------------|--|--------|
| | L: 150 mm D: 190 mm H: 98 mm | | 0,4 kg |
|--|------------------------------------|--|--------|

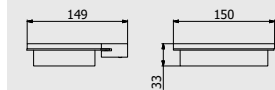

ARTICLE | ARTICOLO | ARTICLE

HJ003



Wall toothbrush holder
Porta spazzolino a muro
Porte brosse à dents encastré

**CODICE / COEFFICIENTE | CODE /
COEFFICIENT | CODE / COEFFICIENT**

| | | |
|----|---------|-----|
| CC | HJ003CC | 6,1 |
| SS | HJ003SS | 6,3 |
| BO | HJ003BO | 6,3 |
| NP | HJ003NP | 6,3 |
| CF | HJ003CF | 6,3 |
| CS | HJ003CS | 6,3 |
| II | HJ003II | 6,3 |
| IS | HJ003IS | 6,3 |
| RS | HJ003RS | 6,3 |
| SR | HJ003SR | 6,3 |
| OO | HJ003OO | 6,3 |
| OS | HJ003OS | 6,3 |

PACKAGING

| | | | |
|--|------------------------------------|--|--------|
| | L: 175 mm D: 125 mm H: 90 mm | | 0,2 kg |
|--|------------------------------------|--|--------|

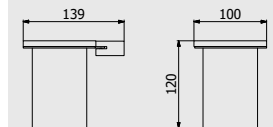

ARTICLE | ARTICOLO | ARTICLE

HJ016



Soap dispenser
Porta sapone da appoggio
Porte distributeur de savon

**CODICE / COEFFICIENTE | CODE /
COEFFICIENT | CODE / COEFFICIENT**

| | | |
|----|---------|-----|
| CC | HJ016CC | 2,2 |
| SS | HJ016SS | 2,4 |
| BO | HJ016BO | 2,4 |
| NP | HJ016NP | 2,4 |
| CF | HJ016CF | 2,4 |
| CS | HJ016CS | 2,4 |
| II | HJ016II | 2,4 |
| IS | HJ016IS | 2,4 |
| RS | HJ016RS | 2,4 |
| SR | HJ016SR | 2,4 |
| OO | HJ016OO | 2,4 |
| OS | HJ016OS | 2,4 |

PACKAGING

| | | | |
|--|------------------------------------|--|--------|
| | L: 150 mm D: 190 mm H: 98 mm | | 1,1 kg |
|--|------------------------------------|--|--------|

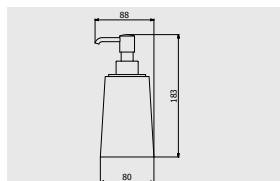

ARTICLE | ARTICOLO | ARTICLE

HJ017



Soap holder
Porta sapone da appoggio
Porte savon

**CODE / COEFFICIENT | CODE /
COEFFICIENT | CODE / COEFFICIENT**

| | | |
|----|---------|-----|
| CC | HJ017CC | 3,8 |
|----|---------|-----|

PACKAGING

| | | | |
|--|------------------------------------|--|--------|
| | L: 175 mm D: 125 mm H: 90 mm | | 0,5 kg |
|--|------------------------------------|--|--------|

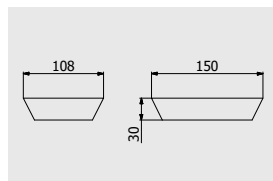

ARTICLE | ARTICOLO | ARTICLE

HJ010

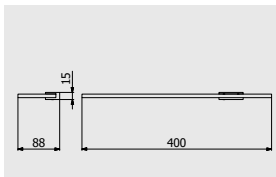

Shelf

Mensola

Etagère

CODICE / COEFFICIENTE | CODE /
COEFFICIENT | CODE / COEFFICIENT

| | | |
|----|---------|-----|
| CC | HJ010CC | 5,1 |
| SS | HJ010SS | 5,3 |
| BO | HJ010BO | 5,3 |
| NP | HJ010NP | 5,3 |
| CF | HJ010CF | 5,3 |
| CS | HJ010CS | 5,3 |
| II | HJ010II | 5,3 |
| IS | HJ010IS | 5,3 |
| RS | HJ010RS | 5,3 |
| SR | HJ010SR | 5,3 |
| OO | HJ010OO | 5,3 |
| OS | HJ010OS | 5,3 |

PACKAGING

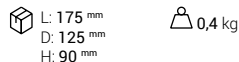

ARTICLE | ARTICOLO | ARTICLE

HJ011

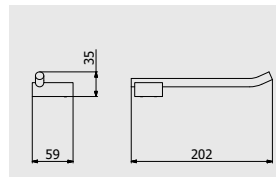

Toilet paper holder

Porta rotolo

Porte rouleaux de toilette

CODICE / COEFFICIENTE | CODE /
COEFFICIENT | CODE / COEFFICIENT

| | | |
|----|---------|-----|
| CC | HJ011CC | 3,5 |
| SS | HJ011SS | 4,4 |
| BO | HJ011BO | 4,4 |
| NP | HJ011NP | 4,2 |
| CF | HJ011CF | 5,3 |
| CS | HJ011CS | 5,7 |
| II | HJ011II | 5,3 |
| IS | HJ011IS | 5,7 |
| RS | HJ011RS | 5,3 |
| SR | HJ011SR | 5,7 |
| OO | HJ011OO | 5,7 |
| OS | HJ011OS | 5,3 |

PACKAGING

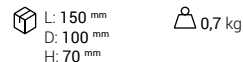

ARTICLE | ARTICOLO | ARTICLE

HJ009

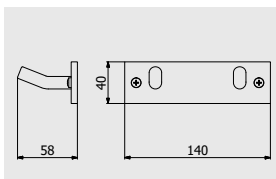

Double robe hook

Doppio appendino a parete

Double cintre

CODICE / COEFFICIENTE | CODE /
COEFFICIENT | CODE / COEFFICIENT

| | | |
|----|---------|-----|
| CC | HJ009CC | 3,4 |
| SS | HJ009SS | 4,3 |
| BO | HJ009BO | 4,3 |
| NP | HJ009NP | 4,3 |
| CF | HJ009CF | 5,1 |
| CS | HJ009CS | 5,4 |
| II | HJ009II | 5,4 |
| IS | HJ009IS | 5,4 |
| RS | HJ009RS | 5,1 |
| SR | HJ009SR | 5,4 |
| OO | HJ009OO | 5,1 |
| OS | HJ009OS | 5,4 |

PACKAGING

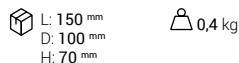

ARTICLE | ARTICOLO | ARTICLE

HJ004

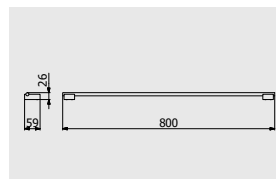

Towel holder

Porta salvietta

Porte-serviette

CODICE / COEFFICIENTE | CODE /
COEFFICIENT | CODE / COEFFICIENT

| | | |
|----|---------|------|
| CC | HJ004CC | 7,5 |
| SS | HJ004SS | 9,4 |
| BO | HJ004BO | 9,4 |
| NP | HJ004NP | 9,4 |
| CF | HJ004CF | 11,3 |
| CS | HJ004CS | 12,0 |
| II | HJ004II | 11,3 |
| IS | HJ004IS | 12,0 |
| RS | HJ004RS | 11,3 |
| SR | HJ004SR | 12,0 |
| OO | HJ004OO | 11,3 |
| OS | HJ004OS | 12,0 |

PACKAGING

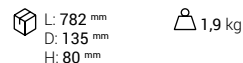

ARTICLE | ARTICOLO | ARTICLE

HJ014

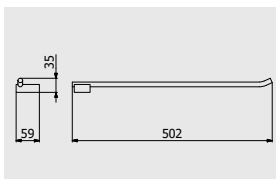

Towel holder

Porta salvietta

Porte-serviette

CODICE / COEFFICIENTE | CODE /
COEFFICIENT | CODE / COEFFICIENT

| | | |
|----|---------|-----|
| CC | HJ014CC | 5,1 |
| SS | HJ014SS | 6,4 |
| BO | HJ014BO | 6,4 |
| NP | HJ014NP | 6,4 |
| CF | HJ014CF | 7,7 |
| CS | HJ014CS | 8,2 |
| II | HJ014II | 7,7 |
| IS | HJ014IS | 8,2 |
| RS | HJ014RS | 7,7 |
| SR | HJ014SR | 8,2 |
| OO | HJ014OO | 7,7 |
| OS | HJ014OS | 8,2 |

PACKAGING

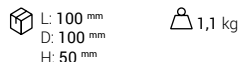

ARTICLE | ARTICOLO | ARTICLE

HJ006

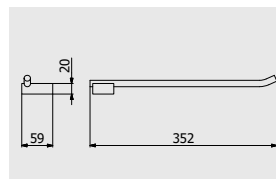

Towel holder

Porta salvietta

Porte-serviette

CODICE / COEFFICIENTE | CODE /
COEFFICIENT | CODE / COEFFICIENT

| | | |
|----|---------|-----|
| CC | HJ006CC | 4,9 |
| SS | HJ006SS | 6,1 |
| BO | HJ006BO | 6,1 |
| NP | HJ006NP | 6,1 |
| CF | HJ006CF | 7,4 |
| CS | HJ006CS | 7,8 |
| II | HJ006II | 7,4 |
| IS | HJ006IS | 7,8 |
| RS | HJ006RS | 7,4 |
| SR | HJ006SR | 7,8 |
| OO | HJ006OO | 7,4 |
| OS | HJ006OS | 7,8 |

PACKAGING

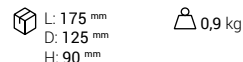

ARTICLE | ARTICOLO | ARTICLE

HJ007

Ring Towel holder

Porta salvietta ad anello

Porte-serviette anneau

CODICE / COEFFICIENTE | CODE / COEFFICIENT

| | | |
|----|---------|-----|
| CC | HJ007CC | 5,0 |
| SS | HJ007SS | 6,3 |
| BO | HJ007BO | 6,3 |
| NP | HJ007NP | 6,3 |
| CF | HJ007CF | 7,5 |
| CS | HJ007CS | 8,0 |
| II | HJ007II | 7,5 |
| IS | HJ007IS | 8,0 |
| RS | HJ007RS | 7,5 |
| SR | HJ007SR | 8,0 |
| OO | HJ007OO | 7,5 |
| OS | HJ007OS | 8,0 |

PACKAGING

| | | | |
|--|-----------|--|--------|
| | L: 340 mm | | 1,9 kg |
| | D: 180 mm | | |
| | H: 70 mm | | |

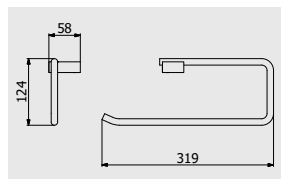

ARTICLE | ARTICOLO | ARTICLE

HJ012

Toilet brush holder

Porta scopino da terra

Porte balayette au sol

CODICE / COEFFICIENTE | CODE / COEFFICIENT

| | | |
|----|---------|------|
| CC | HJ012CC | 7,8 |
| SS | HJ012SS | 9,8 |
| BO | HJ012BO | 9,8 |
| NP | HJ012NP | 9,8 |
| CF | HJ012CF | 11,7 |
| CS | HJ012CS | 12,5 |
| II | HJ012II | 11,7 |
| IS | HJ012IS | 12,5 |
| RS | HJ012RS | 11,7 |
| SR | HJ012SR | 12,5 |
| OO | HJ012OO | 11,7 |
| OS | HJ012OS | 12,5 |

PACKAGING

| | | | |
|--|-----------|--|--------|
| | L: 100 mm | | 1,8 kg |
| | D: 100 mm | | |
| | H: 50 mm | | |

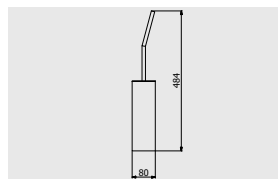

ARTICLE | ARTICOLO | ARTICLE

HJ015

Toothbrush holder

Porta spazzolino

Porte brosse à dents

CODICE / COEFFICIENTE | CODE / COEFFICIENT

| | | |
|----|---------|-----|
| CC | HJ015CC | 2,8 |
|----|---------|-----|

PACKAGING

| | | | |
|--|-----------|--|--------|
| | L: 175 mm | | 0,6 kg |
| | D: 125 mm | | |
| | H: 90 mm | | |

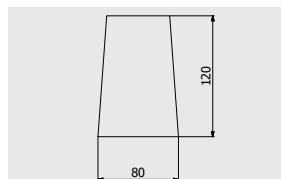

ARTICLE | ARTICOLO | ARTICLE

HJ018

Box

Scatola

Boîte

CODICE / COEFFICIENTE | CODE / COEFFICIENT

| | | |
|----|---------|-----|
| CC | HJ018CC | 4,1 |
| SS | HJ018SS | 4,3 |
| BO | HJ018BO | 4,3 |
| NP | HJ018NP | 4,3 |
| CF | HJ018CF | 4,3 |
| CS | HJ018CS | 4,3 |
| II | HJ018II | 4,3 |
| IS | HJ018IS | 4,3 |
| RS | HJ018RS | 4,3 |
| SR | HJ018SR | 4,3 |
| OO | HJ018OO | 4,3 |
| OS | HJ018OS | 4,3 |

PACKAGING

| | | | |
|--|-----------|--|--------|
| | L: 240 mm | | 1,2 kg |
| | D: 215 mm | | |
| | H: 110 mm | | |

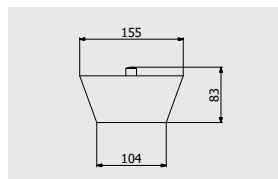

Loveme

BELMONDO / ELLE

The sparkling elegance of the roaring Twenties and Thirties.

L'eleganza sfavillante dei ruggenti anni Venti e Trenta.
L'élégance étincelante des années rugissantes 1920 et 1930.

A collection inspired by the sparkling style of the roaring Twenties and Thirties, with its octagonal shapes that recall the stick figure of a diamond, with geometric and particularly sophisticated lines. This emblematic and refined collection, suitable for any domestic environment, is made even more versatile by the double set of levers available. The free-jet spout guarantees an immediate and spontaneous water flow.

Una serie ispirata allo stile sfavillante dei ruggenti anni Venti e Trenta, con le sue forme ottagonali che richiamano la figura stilizzata di un diamante, linee geometriche eleganti e tratti particolarmente sofisticati. Questa linea emblematica e raffinata, adatta a qualsiasi ambiente casalingo, è resa ulteriormente versatile dalla disponibilità di una doppia leva. La bocca a getto libero garantisce un flusso d'acqua immediato e spontaneo.

Une collection inspirée par le style étincelant des années folles 1920 et 1930, avec ses formes octogonales qui rappellent la silhouette stylisée d'un diamant, avec ses lignes géométriques élégantes et ses traits particulièrement sophistiquées. Cette collection emblématique et raffinée, apte à tous les environnements domestiques, est rendue encore plus polyvalente par la disponibilité d'un double levier. Le bec au jet libre garantit un débit d'eau immédiat et spontané.



ANTI-LIMESCALE
AERATOR

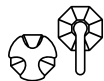

DOUBLE LEVER



LEAD FREE



ZINC FREE





The name refers to the “beautiful world” of the Twenties and the Thirties, to the luxurious houses of those times, with real bathrooms and multiple fragrances.

Il nome si riferisce al “bel mondo” degli anni Venti e Trenta, a quelle case lussuose dell'epoca con vere stanze da bagno e tanti profumi.

Le nom fait référence au «monde magnifique» des années 1920 et 1930, à ces maisons luxueuses de l'époque, avec des vraies salles de bains et des nombreux parfums.

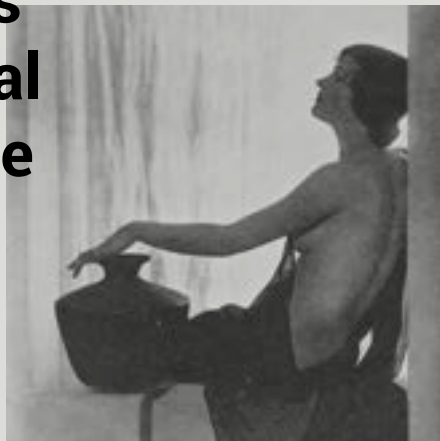

“ *Through this project I wanted to go deep inside the culture of the period between the two world wars, inspiring myself above all to Jean Puiforcat, French artist and designer who worked during those years. Even if it reminds to sophisticated cultural atmosphere from that age, these objects are still deeply original and they don't concern with imitation styling.*

Ho voluto fare un'immersione culturale nel raffinato design del periodo fra le due guerre, ispirandomi liberamente, soprattutto alla figura di Jean Puiforcat, artista e designer francese operante in quegli anni. Pur rimandando ad atmosfere di sofisticato lusso di certi ambienti culturali di quell'epoca, tuttavia questi oggetti restano sempre appartenenti ad un ambito di originalità progettuale che non sconfigna mai in styling d'imitazione.

À travers ce projet, j'ai voulu aller au cœur de la culture de l'entre-deux-guerres, en m'inspirant avant tout de Jean Puiforcat, artiste et designer français de ces années. Même s'ils évoquent l'ambiance culturel sophistiqué de ces années, ces objets demeurent quand même profondément originaux, peu intéressés à un style d'imitation.

”

Maurizio Duranti design for BELMONDO



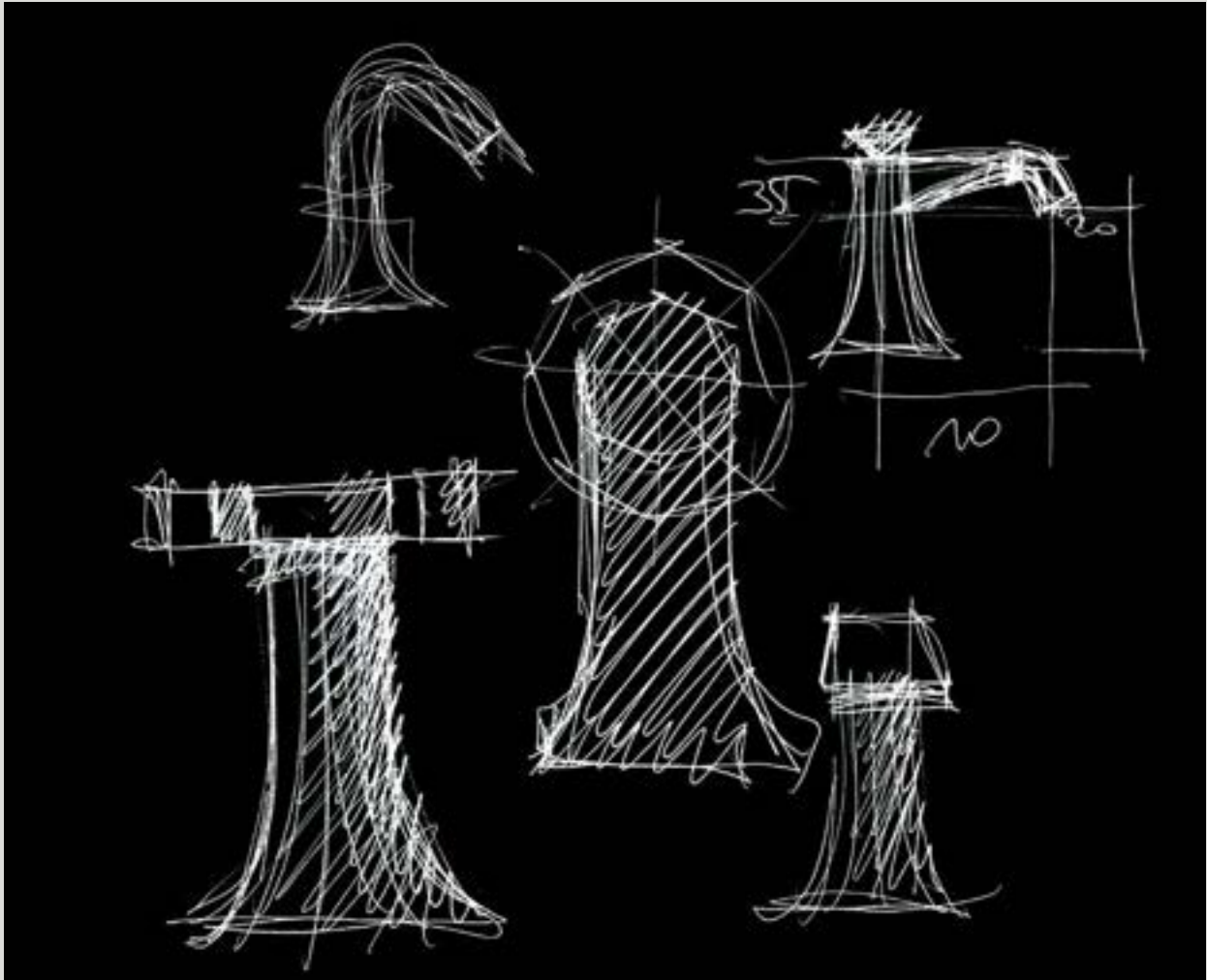



- ← BL200CC
- Monohole washbasin mixer
Miscelatore lavabo monoforo
Mitigeur lavabo complet

- ↙ BT205CC
- Monohole washbasin with two handles with drain
Lavabo monoforo con due leve
Mélangeur Lavabo Monotrou





Belmondo





← BL392RS
Three holes washbasin set with low spout
Lavabo tre fori bocca bassa
Lavabo trois trous bec bas

↑ BT392CC
Three holes washbasin set with low spout
Lavabo tre fori bocca bassa
Lavabo trois trous bec bas





Belmondo

- ← BT39300
Three holes bidet set
Bidet tre fori con bocca snodabile
Bidet trois trous
- ↑ BT306CC
Wall mounted washbasin mixer
Miscelatore lavabo due fori a parete
Mitigeur lavabo mural
- BL010
Shelf
Mensola
Etagère





- ← **BL300CC**
Exposed parts for manual wall mixer
Set di parti esterne per miscelatore a parete ad una via
Partie extérieure pour mitigeur encastré à une voie

- ↙ **BL001**
Wall soap-holder
Porta sapone a muro
Porte distributeur de savon encastré

- **BL314CC**
Exposed parts for manual wall mixer with three ways diverter complete with shower kit
Set di parti esterne per miscelatore a parete a tre vie completo di kit doccia
Partie extérieure pour mitigeur encastré à trois voies avec douchette





Belmondo



↑ **BL350CC**

Wall mounted shower mixer with shower kit
Doccia esterno a parete di kit doccia
Mitigeur de douche externe avec flexible et
douchette

↗ **BL410CC**

Three holes wall mounted shower with two
ways diverter
Tre rubinetti a parete per doccia con deviatore
a due vie
Melangeur trois trous douche avec inverseur
deux voies



Belmondo



← **BL250CC**
 Wall mounted bath filler with hand shower kit
 Bordo vasca esterno a parete di kit doccia
 Mitigeur bain/douche mural avec douchette
 encastrée

↓ **BL396CC**
 Five holes deck mounted bath filler with
 shower kit
 Bordo vasca cinque fori con deviatore e kit doccia
 Bain/douche 5 trous avec inverseur et kit douche

| | |
|---------------------|----------------------|
| A Hot water | D Diverter |
| Acqua calda | Deviatore |
| Eau chaude | Déviateur |
| B Spout | E Hand shower |
| Bocca d'erogazione | Doccino |
| Bec | Douchette |
| C Cold water | |
| Acqua fredda | |
| Eau froide | |

→ **BL700CC**
 Free-standing two columns bath filler with
 shower kit
 Bordo vasca da terra a doppia colonna con
 kit doccia
 Mélangeur bain/douche complet avec
 alimentation sol





Belmondo



ARTICLE | ARTICOLO | ARTICLE

BL200



Monohole washbasin mixer complete with drain

Miscelatore lavabo monoforo completo di scarico automatico

Mélangeur lavabo complet avec bonde automatique

CODE / COEFFICIENT | CODICE /
COEFFICIENTE | CODE / COEFFICIENT

| | | |
|------|---------|------|
| ● CC | BL200CC | 8,5 |
| ● PL | BL200PL | 13,6 |
| ● II | BL200II | 12,8 |
| ● RS | BL200RS | 12,8 |
| ● OO | BL200OO | 12,8 |

PACKAGING

 L: 340 mm
D: 180 mm
H: 70 mm

1,9 kg

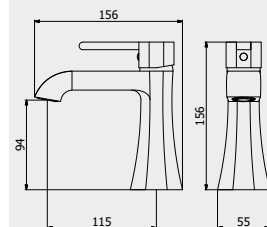

PORTATE | WATER FLOW | DÉBIT D'EAU

| | | |
|---------|-------|--------|
| 1 BAR | 2 BAR | 3 BAR |
| 9,5 l/m | 13l/m | 19 l/m |

ARTICLE | ARTICOLO | ARTICLE

BT205



Monohole washbasin with two handles complete with drain

Lavabo monoforo con due leve completo di scarico automatico

Mélangeur lavabo monotrou complet avec bonde automatique

CODE / COEFFICIENT | CODICE /
COEFFICIENTE | CODE / COEFFICIENT

| | | |
|------|---------|------|
| ● CC | BT205CC | 9,6 |
| ● PL | BT205PL | 15,4 |
| ● II | BT205II | 14,4 |
| ● RS | BT205RS | 14,4 |
| ● OO | BT205OO | 14,4 |

PACKAGING

 L: 360 mm
D: 220 mm
H: 150 mm

2,7 kg

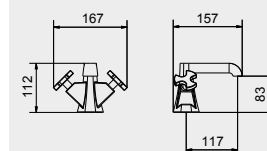

PORTATE | WATER FLOW | DÉBIT D'EAU

| | | |
|----------|----------|----------|
| 1 BAR | 2 BAR | 3 BAR |
| 16,2 l/m | 23,1 l/m | 28,5 l/m |

ARTICLE | ARTICOLO | ARTICLE

BL205



Monohole washbasin with two handles complete with drain

Lavabo monoforo con due leve completo di scarico automatico

Mélangeur lavabo monotrou complet avec bonde automatique

CODE / COEFFICIENT | CODICE /
COEFFICIENTE | CODE / COEFFICIENT

| | | |
|------|---------|------|
| ● CC | BL205CC | 9,6 |
| ● PL | BL205PL | 15,4 |
| ● II | BL205II | 14,4 |
| ● RS | BL205RS | 14,4 |
| ● OO | BL205OO | 14,4 |

PACKAGING

 L: 360 mm
D: 220 mm
H: 150 mm

2,8 kg

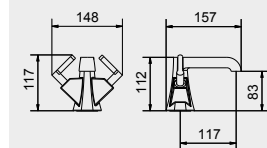

PORTATE | WATER FLOW | DÉBIT D'EAU

| | | |
|----------|----------|----------|
| 1 BAR | 2 BAR | 3 BAR |
| 26,2 l/m | 23,1 l/m | 28,5 l/m |

ARTICLE | ARTICOLO | ARTICLE

BT306



Wall mounted widespread lavatory faucet

Rubinetto lavabo da incasso

Robinet de lavabo mural

CODE / COEFFICIENT | CODICE /
COEFFICIENTE | CODE / COEFFICIENT

| | | |
|------|---------|------|
| ● CC | BT306CC | 12,3 |
| ● PL | BT306PL | 19,7 |
| ● II | BT306II | 18,5 |
| ● RS | BT306RS | 18,5 |
| ● OO | BT306OO | 18,5 |

PACKAGING

 L: 265 mm
D: 260 mm
H: 70 mm

1,7 kg

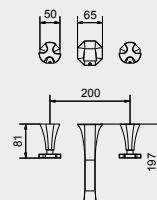

PORTATE | WATER FLOW | DÉBIT D'EAU

| | | |
|---------|---------|---------|
| 1 BAR | 2 BAR | 3 BAR |
| 2,4 l/m | 3,7 l/m | 3,7 l/m |



ARTICLE | ARTICOLO | ARTICLE

BL306



Wall mounted widespread lavatory faucet
 Rubinetto lavabo da incasso
 Robinet de lavabo mural

| CODE / COEFFICIENT | CODICE / COEFFICIENTE | COEFFICIENT |
|--------------------|-----------------------|-------------|
| ● CC | BL306CC | 12,3 |
| ● PL | BL306PL | 19,7 |
| ● II | BL306II | 18,5 |
| ● RS | BL306RS | 18,5 |
| ● OO | BL306OO | 18,5 |

PACKAGING
 L: 265 mm
 D: 260 mm
 H: 70 mm
 1,7 kg

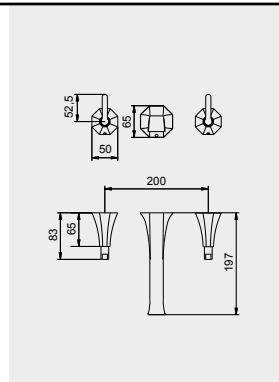

PORTATE | WATER FLOW | DÉBIT D'EAU

| 1 BAR | 2 BAR | 3 BAR |
|---------|---------|---------|
| 2,4 l/m | 3,7 l/m | 3,7 l/m |

ARTICLE | ARTICOLO | ARTICLE

BT390



Three holes washbasin set with tall spout
 Lavabo tre fori bocca alta completo di scarico automatico
 Lavabo trois trous bec haut

| CODE / COEFFICIENT | CODICE / COEFFICIENTE | COEFFICIENT |
|--------------------|-----------------------|-------------|
| ● CC | BT390CC | 13,9 |
| ● PL | BT390PL | 22,2 |
| ● II | BT390II | 20,9 |
| ● RS | BT390RS | 20,9 |
| ● OO | BT390OO | 20,9 |

PACKAGING
 L: 370 mm
 D: 270 mm
 H: 80 mm
 5,2 kg

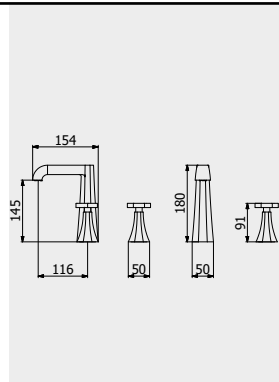

PORTATE | WATER FLOW | DÉBIT D'EAU

| 1 BAR | 2 BAR | 3 BAR |
|---------|-------|-------|
| 3,5 l/m | 4 l/m | 4 l/m |

ARTICLE | ARTICOLO | ARTICLE

BL390



Three holes washbasin set with tall spout
 Lavabo tre fori bocca alta completo di scarico automatico
 Lavabo trois trous bec haut

| CODE / COEFFICIENT | CODICE / COEFFICIENTE | COEFFICIENT |
|--------------------|-----------------------|-------------|
| ● CC | BL390CC | 13,9 |
| ● PL | BL390PL | 22,2 |
| ● II | BL390II | 20,9 |
| ● RS | BL390RS | 20,9 |
| ● OO | BL390OO | 20,9 |

PACKAGING
 L: 370 mm
 D: 270 mm
 H: 80 mm
 5,2 kg

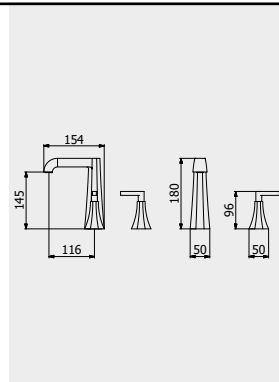

PORTATE | WATER FLOW | DÉBIT D'EAU

| 1 BAR | 2 BAR | 3 BAR |
|---------|-------|-------|
| 3,5 l/m | 4 l/m | 4 l/m |

ARTICLE | ARTICOLO | ARTICLE

BT392



Three holes washbasin set with low spout
 Lavabo tre fori a bocca bassa completo di scarico automatico
 Lavabo trois trous bec bas

| CODE / COEFFICIENT | CODICE / COEFFICIENTE | COEFFICIENT |
|--------------------|-----------------------|-------------|
| ● CC | BT392CC | 12,3 |
| ● PL | BT392PL | 19,7 |
| ● II | BT392II | 18,5 |
| ● RS | BT392RS | 18,5 |
| ● OO | BT392OO | 18,5 |

PACKAGING
 L: 370 mm
 D: 270 mm
 H: 80 mm
 4,3 kg

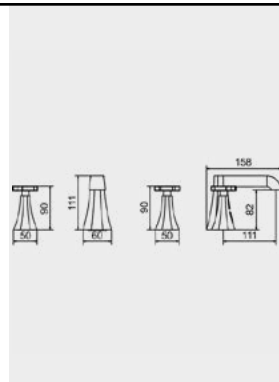

PORTATE | WATER FLOW | DÉBIT D'EAU

| 1 BAR | 2 BAR | 3 BAR |
|---------|-------|-------|
| 3,5 l/m | 4 l/m | 4 l/m |

Belmondo

ARTICLE | ARTICOLO | ARTICLE

BL392



Three holes washbasin set with low spout

Lavabo tre fori a bocca bassa completo di scarico automatico

Lavabo trois trous bec bas

CODE / COEFFICIENT | CODICE /
COEFFICIENTE | CODE / COEFFICIENT

| | | |
|------|---------|------|
| ● CC | BL392CC | 12,3 |
| ● PL | BL392PL | 19,7 |
| ● II | BL392II | 18,5 |
| ● RS | BL392RS | 18,5 |
| ● OO | BL392OO | 18,5 |

PACKAGING

 L: 370 mm
D: 270 mm
H: 80 mm

4,3 kg

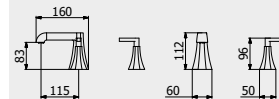

PORTATE | WATER FLOW | DÉBIT D'EAU

| | | |
|---------|-------|-------|
| 1 BAR | 2 BAR | 3 BAR |
| 3,5 l/m | 4 l/m | 4 l/m |

ARTICLE | ARTICOLO | ARTICLE

BL210

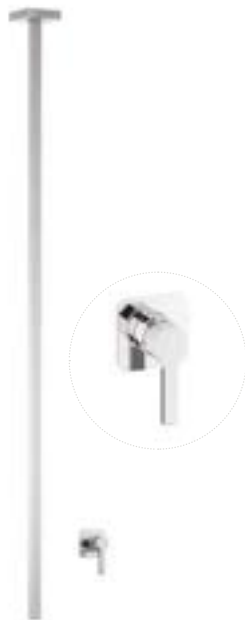

Ceiling spout with wall mounted mixer

Bocca da soffitto con comando remoto ad incasso

Mitigeur lavabo mural avec bec plafond complet avec bonde automatique

CODE / COEFFICIENT | CODICE /
COEFFICIENTE | CODE / COEFFICIENT

| | | |
|------|----------|------|
| ● CC | EBL210CC | 33,8 |
| ● PL | EBL210PL | 54,0 |
| ● II | EBL210II | 50,6 |
| ● RS | EBL210RS | 50,6 |
| ● OO | EBL210OO | 50,6 |

PACKAGING

 L: 150 mm
D: 190 mm
H: 98 mm

 L: 1700 mm
Ø: 70 mm

4,5 kg

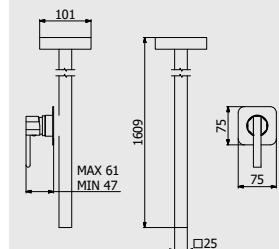

PORTATE | WATER FLOW | DÉBIT D'EAU

| | | |
|---------|---------|-------|
| 1 BAR | 2 BAR | 3 BAR |
| 4,3 l/m | 5,2 l/m | 7 l/m |

! Built-in body to be purchased separately

Corpo incasso da acquistare separatamente

Corps intégré à acheter séparément



CODICE | CODE | CODE

INC300XXXN_19

COEFFICIENTE | COEFFICIENT | COEFFICIENT

1,8



ARTICLE | ARTICOLO | ARTICLE

BL220



Monohole bidet mixer complete with drain

Miscelatore bidet monoforo completo di scarico automatico

Mitigeur bidet complet avec bonde automatique

CODE / COEFFICIENT | CODICE /
COEFFICIENTE | CODE / COEFFICIENT

| | | |
|------|---------|------|
| ● CC | BL220CC | 8,5 |
| ● PL | BL220PL | 13,6 |
| ● II | BL220II | 12,8 |
| ● RS | BL220RS | 12,8 |
| ● OO | BL220OO | 12,8 |

PACKAGING

 L: 340 mm
D: 180 mm
H: 70 mm

1,8 kg

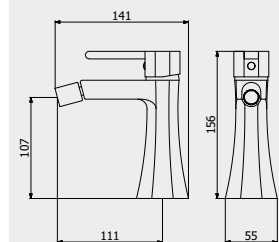

PORTATE | WATER FLOW | DÉBIT D'EAU

| | | |
|---------|--------|--------|
| 1 BAR | 2 BAR | 3 BAR |
| 9,5 l/m | 13 l/m | 19 l/m |



ARTICLE | ARTICOLO | ARTICLE

BT225



Monohole bidet with two handles complete with drain
 Bidet monoforo con due leve completo di scarico automatico
 Melangeur bidet monotrou complet avec bonde automatique

| CODE / COEFFICIENT CODICE / COEFFICIENTE | COEFFICIENTE CODE / COEFFICIENT |
|--|-----------------------------------|
| CC BT225CC | 9,6 |
| PL BT225PL | 15,4 |
| II BT225II | 14,4 |
| RS BT225RS | 14,4 |
| OO BT225OO | 14,4 |

PACKAGING

L: 360 mm
 D: 220 mm
 H: 150 mm

2,6 kg

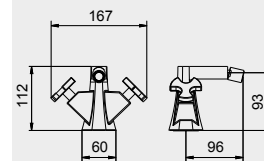

PORTATE | WATER FLOW | DÉBIT D'EAU

| 1 BAR | 2 BAR | 3 BAR |
|-------|----------|----------|
| 8 l/m | 10,6 l/m | 13,1 l/m |

ARTICLE | ARTICOLO | ARTICLE

BL225



Monohole bidet with two handles complete with drain
 Bidet monoforo con due leve completo di scarico automatico
 Melangeur bidet monotrou complet avec bonde automatique

| CODE / COEFFICIENT CODICE / COEFFICIENTE | COEFFICIENTE CODE / COEFFICIENT |
|--|-----------------------------------|
| CC BL225CC | 9,6 |
| PL BL225PL | 15,4 |
| II BL225II | 14,4 |
| RS BL225RS | 14,4 |
| OO BL225OO | 14,4 |

PACKAGING

L: 360 mm
 D: 220 mm
 H: 150 mm

2,6 kg

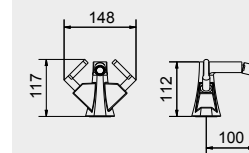

PORTATE | WATER FLOW | DÉBIT D'EAU

| 1 BAR | 2 BAR | 3 BAR |
|-------|----------|----------|
| 8 l/m | 10,6 l/m | 13,1 l/m |

ARTICLE | ARTICOLO | ARTICLE

BT393



Three holes bidet set
 Bidet tre fori con bocca snodabile completo di scarico automatico
 Bidet trois trous

| CODE / COEFFICIENT CODICE / COEFFICIENTE | COEFFICIENTE CODE / COEFFICIENT |
|--|-----------------------------------|
| CC BT393CC | 12,3 |
| PL BT393PL | 19,7 |
| II BT393II | 18,5 |
| RS BT393RS | 18,5 |
| OO BT393OO | 18,5 |

PACKAGING

L: 370 mm
 D: 270 mm
 H: 80 mm

4,6 kg

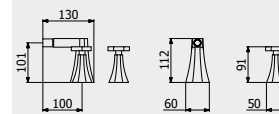

PORTATE | WATER FLOW | DÉBIT D'EAU

| 1 BAR | 2 BAR | 3 BAR |
|---------|-------|-------|
| 3,5 l/m | 4 l/m | 4 l/m |

ARTICLE | ARTICOLO | ARTICLE

BL393



Three holes bidet set
 Bidet tre fori con bocca snodabile completo di scarico automatico
 Bidet trois trous

| CODE / COEFFICIENT CODICE / COEFFICIENTE | COEFFICIENTE CODE / COEFFICIENT |
|--|-----------------------------------|
| CC BL393CC | 12,3 |
| PL BL393PL | 19,7 |
| II BL393II | 18,5 |
| RS BL393RS | 18,5 |
| OO BL393OO | 18,5 |

PACKAGING

L: 370 mm
 D: 270 mm
 H: 80 mm

4,6 kg

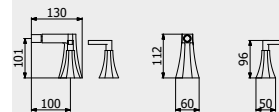

PORTATE | WATER FLOW | DÉBIT D'EAU

| 1 BAR | 2 BAR | 3 BAR |
|---------|-------|-------|
| 3,5 l/m | 4 l/m | 4 l/m |

Belmondo

ARTICLE | ARTICOLO | ARTICLE

BL300



Exposed parts for manual wall mixer

Set di parti esterne per miscelatore a parete ad una via

Partie extérieure pour mitigeur encastré à une voie

CODE / COEFFICIENT | CODICE /
COEFFICIENTE | CODE / COEFFICIENT

| | | |
|------|----------|-----|
| ● CC | EBL300CC | 4,8 |
| ● PL | EBL300PL | 7,7 |
| ● II | EBL300II | 7,2 |
| ● RS | EBL300RS | 7,2 |
| ● OO | EBL300OO | 7,2 |

PACKAGING

 L: 150 mm
D: 190 mm
H: 98 mm

1,8 kg

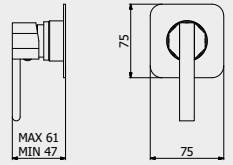

PORTATE | WATER FLOW | DÉBIT D'EAU

| | | |
|----------|----------|--------|
| 1 BAR | 2 BAR | 3 BAR |
| 11,5 l/m | 18,3 l/m | 20 l/m |

Built-in body to be purchased separately

Corpo incasso da acquistare separatamente

Corps intégré à acheter séparément



CODICE | CODE | CODE

INC300XXXN_19

COEFFICIENTE | COEFFICIENT | COEFFICIENT

1,8

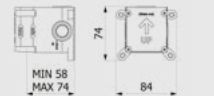

ARTICLE | ARTICOLO | ARTICLEV

BL310



Exposed parts for manual wall mixer with two ways diverter

Miscelatore doccia a parete con deviatore due vie

Mitigeur douche mural deux voies avec inverseur

CODE / COEFFICIENT | CODICE /
COEFFICIENTE | CODE / COEFFICIENT

| | | |
|------|----------|------|
| ● CC | EBL310CC | 7,3 |
| ● PL | EBL310PL | 11,7 |
| ● II | EBL310II | 11,0 |
| ● RS | EBL310RS | 11,0 |
| ● OO | EBL310OO | 11,0 |

PACKAGING

 L: 150 mm
D: 190 mm
H: 98 mm

1,8 kg

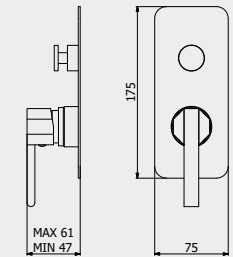

PORTATE | WATER FLOW | DÉBIT D'EAU

| | | |
|----------|----------|--------|
| 1 BAR | 2 BAR | 3 BAR |
| 10,4 l/m | 14,7 l/m | 18 l/m |

Built-in body to be purchased separately

Corpo incasso da acquistare separatamente

Corps intégré à acheter séparément



CODICE | CODE | CODE

INC310XXXN_19

COEFFICIENTE | COEFFICIENT | COEFFICIENT

3,3

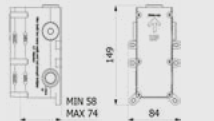

ARTICLE | ARTICOLO | ARTICLE

BL312



Exposed parts for manual wall mixer with three ways diverter

Set di parti esterne per miscelatore a parete a tre vie

Mitigeur douche mural trois voies avec inverseur

CODE / COEFFICIENT | CODICE /
COEFFICIENTE | CODE / COEFFICIENT

| | | |
|------|----------|------|
| ● CC | EBL312CC | 8,6 |
| ● PL | EBL312PL | 13,8 |
| ● II | EBL312II | 12,9 |
| ● RS | EBL312RS | 12,9 |
| ● OO | EBL312OO | 12,9 |

PACKAGING

 L: 150 mm
D: 190 mm
H: 98 mm

1,8 kg

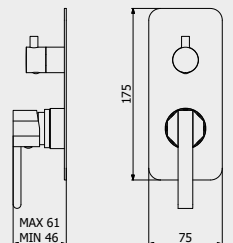

PORTATE | WATER FLOW | DÉBIT D'EAU

| | | |
|---------|----------|----------|
| 1 BAR | 2 BAR | 3 BAR |
| 8,3 l/m | 11,7 l/m | 14,3 l/m |

Built-in body to be purchased separately

Corpo incasso da acquistare separatamente

Corps intégré à acheter séparément



CODICE | CODE | CODE

INC312XXXN_19

COEFFICIENTE | COEFFICIENT | COEFFICIENT

3,3

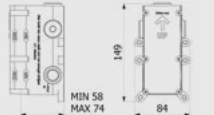

ARTICLE | ARTICOLO | ARTICLE

BL313



Exposed parts for manual wall mixer with 2 ways with shower kit
Set di parti esterne per miscelatore a parete a due vie completo di kit doccia
Partie extérieure pour mitigeur encastré à deux voies avec douchette

| CODE / COEFFICIENT | CODICE / COEFFICIENTE | COEFFICIENT |
|--------------------|-----------------------|-------------|
| CC | EBL313CC | 13,9 |
| PL | EBL313PL | 22,2 |
| II | EBL313II | 20,9 |
| RS | EBL313RS | 20,9 |
| OO | EBL313OO | 20,9 |

PACKAGING

L: 370 mm
D: 270 mm
H: 80 mm
2,1 kg

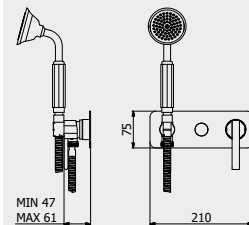

PORTATE | WATER FLOW | DÉBIT D'EAU

| 1 BAR | 2 BAR | 3 BAR |
|--------|----------|----------|
| 10 l/m | 13,1 l/m | 17,2 l/m |

Built-in body to be purchased separately

Corpo incasso da acquistare separatamente
Corps intégré à acheter séparément



CODICE | CODE | CODE

INC313XXXN_19

COEFFICIENTE | COEFFICIENT | COEFFICIENT

3,6



Belmondo

ARTICLE | ARTICOLO | ARTICLE

BL314



Exposed parts for manual wall mixer with 3 ways with shower kit
Set di parti esterne per miscelatore a parete a tre vie completo di kit doccia
Partie extérieure pour mitigeur encastré à trois voies avec douchette

| CODE / COEFFICIENT | CODICE / COEFFICIENTE | COEFFICIENT |
|--------------------|-----------------------|-------------|
| CC | EBL314CC | 15,8 |
| PL | EBL314PL | 25,3 |
| II | EBL314II | 23,7 |
| RS | EBL314RS | 23,7 |
| OO | EBL314OO | 23,7 |

PACKAGING

L: 370 mm
D: 270 mm
H: 80 mm
2,1 kg

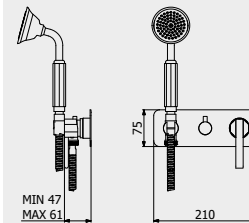

PORTATE | WATER FLOW | DÉBIT D'EAU

| 1 BAR | 2 BAR | 3 BAR |
|---------|----------|----------|
| 8,3 l/m | 11,7 l/m | 14,3 l/m |

Built-in body to be purchased separately

Corpo incasso da acquistare separatamente
Corps intégré à acheter séparément



CODICE | CODE | CODE

INC314XXXN_19

COEFFICIENTE | COEFFICIENT | COEFFICIENT

3,7



ARTICLE | ARTICOLO | ARTICLE

BT400



Two holes wall mounted shower

Coppia di rubinetti a parete per doccia una via
Melangeur deux trous douche

| CODE / COEFFICIENT | CODICE / COEFFICIENTE | COEFFICIENT |
|--------------------|-----------------------|-------------|
| CC | BT400CC | 6,5 |
| PL | BT400PL | 10,4 |
| II | BT400II | 9,8 |
| RS | BT400RS | 9,8 |
| OO | BT400OO | 9,8 |

PACKAGING

L: 175 mm
D: 125 mm
H: 90 mm
1,3 kg

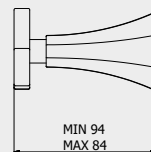

PORTATE | WATER FLOW | DÉBIT D'EAU

| 1 BAR | 2 BAR | 3 BAR |
|--------|--------|----------|
| 28 l/m | 40 l/m | 49,3 l/m |

ARTICLE | ARTICOLO | ARTICLE

BL400



Two holes wall mounted shower

Coppia di rubinetti a parete per doccia una via

Melangeur deux trous douche

CODE / COEFFICIENT | CODICE /
COEFFICIENTE | CODE / COEFFICIENT

| | | | |
|---|----|---------|------|
| ● | CC | BL400CC | 6,5 |
| ● | PL | BL400PL | 10,4 |
| ● | II | BL400II | 9,8 |
| ● | RS | BL400RS | 9,8 |
| ● | OO | BL400OO | 9,8 |

PACKAGING

 L: 175 mm
D: 125 mm
H: 90 mm

1,3 kg

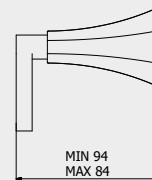

PORTATE | WATER FLOW | DÉBIT D'EAU

| | | |
|--------|--------|----------|
| 1 BAR | 2 BAR | 3 BAR |
| 28 l/m | 40 l/m | 49,3 l/m |

ARTICLE | ARTICOLO | ARTICLE

BT410



Three holes wall mounted shower with two ways diverter

Tre rubinetti a parete per doccia con deviatore a due vie

Melangeur trois trous douche avec inverseur deux voies

CODE / COEFFICIENT | CODICE /
COEFFICIENTE | CODE / COEFFICIENT

| | | | |
|---|----|---------|------|
| ● | CC | BT410CC | 10,5 |
| ● | PL | BT410PL | 16,8 |
| ● | II | BT410II | 15,8 |
| ● | RS | BT410RS | 15,8 |
| ● | OO | BT410OO | 15,8 |

PACKAGING

 L: 340 mm
D: 180 mm
H: 70 mm

1,7 kg

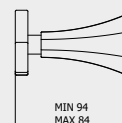

PORTATE | WATER FLOW | DÉBIT D'EAU

| | | |
|--------|----------|----------|
| 1 BAR | 2 BAR | 3 BAR |
| 26 l/m | 22,4 l/m | 27,4 l/m |

ARTICLE | ARTICOLO | ARTICLE

BL410



Three holes wall mounted shower with two ways diverter

Tre rubinetti a parete per doccia con deviatore a due vie

Melangeur 3 trous douche avec inverseur deux voies

CODE / COEFFICIENT | CODICE /
COEFFICIENTE | CODE / COEFFICIENT

| | | | |
|---|----|---------|------|
| ● | CC | BL410CC | 10,5 |
| ● | PL | BL410PL | 16,8 |
| ● | II | BL410II | 15,8 |
| ● | RS | BL410RS | 15,8 |
| ● | OO | BL410OO | 15,8 |

PACKAGING

 L: 340 mm
D: 180 mm
H: 70 mm

1,7 kg

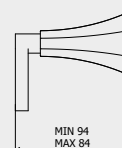

PORTATE | WATER FLOW | DÉBIT D'EAU

| | | |
|--------|--------|--------|
| 1 BAR | 2 BAR | 3 BAR |
| 15 l/m | 22 l/m | 32 l/m |

ARTICLE | ARTICOLO | ARTICLE

BT320



Wall mounted spout

Bocca d'erogazione a parete

Bec de remplissage mural

CODE / COEFFICIENT | CODICE /
COEFFICIENTE | CODE / COEFFICIENT

| | | | |
|---|----|---------|-----|
| ● | CC | BT320CC | 3,9 |
| ● | PL | BT320PL | 6,2 |
| ● | II | BT320II | 5,9 |
| ● | RS | BT320RS | 5,9 |
| ● | OO | BT320OO | 5,9 |

PACKAGING

 L: 210 mm
D: 130 mm
H: 70 mm

1,1 kg

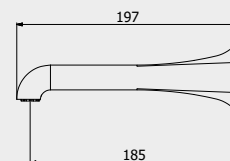

PORTATE | WATER FLOW | DÉBIT D'EAU

| | | |
|---------|---------|---------|
| 1 BAR | 2 BAR | 3 BAR |
| 2,4 l/m | 3,7 l/m | 3,7 l/m |



ARTICLE | ARTICOLO | ARTICLE

BT350



Wall mounted shower mixer with shower kit
 Doccia esterno a parete completo di kit doccia
 Mitigeur de douche externe avec flexible et douchette

| CODE / COEFFICIENT | CODICE / COEFFICIENTE | |
|--------------------|-----------------------|------|
| CC | BT350CC | 14,4 |
| PL | BT350PL | 23,0 |
| II | BT350II | 21,6 |
| RS | BT350RS | 21,6 |
| OO | BT350OO | 21,6 |

PACKAGING

| |
|-----------|
| L: 360 mm |
| D: 220 mm |
| H: 150 mm |
| 2,5 kg |

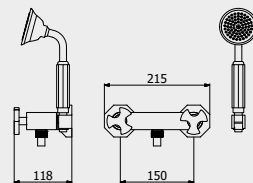

PORTATE | WATER FLOW | DÉBIT D'EAU

| | | |
|----------|----------|--------|
| 1 BAR | 2 BAR | 3 BAR |
| 12,4 l/m | 27,6 l/m | 22 l/m |

ARTICLE | ARTICOLO | ARTICLE

BL350



Wall mounted shower mixer with shower kit
 Doccia esterno a parete completo di kit doccia
 Mitigeur de douche externe avec flexible et douchette

| CODE / COEFFICIENT | CODICE / COEFFICIENTE | |
|--------------------|-----------------------|------|
| CC | BL350CC | 14,4 |
| PL | BL350PL | 23,0 |
| II | BL350II | 21,6 |
| RS | BL350RS | 21,6 |
| OO | BL350OO | 21,6 |

PACKAGING

| |
|-----------|
| L: 360 mm |
| D: 220 mm |
| H: 150 mm |
| 2,5 kg |

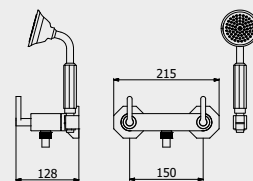

PORTATE | WATER FLOW | DÉBIT D'EAU

| | | |
|----------|----------|--------|
| 1 BAR | 2 BAR | 3 BAR |
| 12,4 l/m | 27,6 l/m | 22 l/m |

Belmondo

ARTICLE | ARTICOLO | ARTICLE

BT250



Wall mounted bath filler complete with hand shower kit
 Bordo vasca esterno a parete completo di kit doccia
 Mitigeur Bain/douche Mural avec douchette encastrée

| CODE / COEFFICIENT | CODICE / COEFFICIENTE | |
|--------------------|-----------------------|------|
| CC | BT250CC | 23,4 |
| PL | BT250PL | 37,4 |
| II | BT250II | 35,1 |
| RS | BT250RS | 35,1 |
| OO | BT250OO | 35,1 |

PACKAGING

| |
|-----------|
| L: 360 mm |
| D: 220 mm |
| H: 220 mm |
| 5,1 kg |

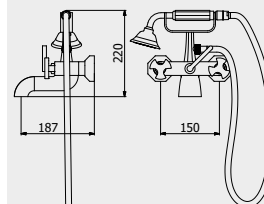

PORTATE | WATER FLOW | DÉBIT D'EAU

| | | |
|----------|----------|--------|
| 1 BAR | 2 BAR | 3 BAR |
| 32,5 l/m | 45,8 l/m | 56 l/m |

ARTICLE | ARTICOLO | ARTICLE

BL250



Wall mounted bath filler complete with hand shower kit
 Bordo vasca esterno a parete completo di kit doccia
 Mitigeur Bain/douche Mural avec douchette encastrée

| CODE / COEFFICIENT | CODICE / COEFFICIENTE | |
|--------------------|-----------------------|------|
| CC | BL250CC | 23,4 |
| PL | BL250PL | 37,4 |
| II | BL250II | 35,1 |
| RS | BL250RS | 35,1 |
| OO | BL250OO | 35,1 |

PACKAGING

| |
|-----------|
| L: 360 mm |
| D: 220 mm |
| H: 220 mm |
| 5,1 kg |

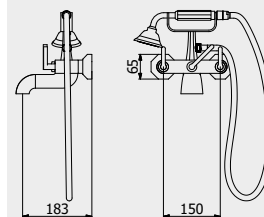

PORTATE | WATER FLOW | DÉBIT D'EAU

| | | |
|----------|----------|--------|
| 1 BAR | 2 BAR | 3 BAR |
| 32,5 l/m | 45,8 l/m | 56 l/m |

ARTICLE | ARTICOLO | ARTICLE

BT396



Five holes deck mounted bath filler with shower kit

Bordo vasca cinque fori con deviatore e kit doccia

Bain/douche cinq trous avec inverseur et Kit Douche

CODE / COEFFICIENT | CODICE /
COEFFICIENTE | CODE / COEFFICIENT

| | | |
|------|---------|------|
| ● CC | BT396CC | 24,6 |
| ● PL | BT396PL | 39,4 |
| ● II | BT396II | 36,9 |
| ● RS | BT396RS | 36,9 |
| ● OO | BT396OO | 36,9 |

PACKAGING

L: 400 mm
D: 250 mm
H: 140 mm

4,4 kg

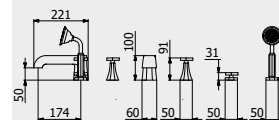

PORTATE | WATER FLOW | DÉBIT D'EAU

| | | |
|--------|--------|--------|
| 1 BAR | 2 BAR | 3 BAR |
| 19 l/m | 27 l/m | 33 l/m |

ARTICLE | ARTICOLO | ARTICLE

BL396



Five holes deck mounted bath filler with shower kit

Bordo vasca cinque fori con deviatore e kit doccia

Bain/douche cinq trous avec inverseur et Kit Douche

CODE / COEFFICIENT | CODICE /
COEFFICIENTE | CODE / COEFFICIENT

| | | |
|------|---------|------|
| ● CC | BL396CC | 24,6 |
| ● PL | BL396PL | 39,4 |
| ● II | BL396II | 36,9 |
| ● RS | BL396RS | 36,9 |
| ● OO | BL396OO | 36,9 |

PACKAGING

L: 400 mm
D: 250 mm
H: 140 mm

4,4 kg

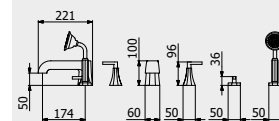

PORTATE | WATER FLOW | DÉBIT D'EAU

| | | |
|--------|--------|--------|
| 1 BAR | 2 BAR | 3 BAR |
| 19 l/m | 27 l/m | 33 l/m |

ARTICLE | ARTICOLO | ARTICLE

BT397



4 holes bath filler with overflow outlet connection, diverter and shower kit

Bordo vasca 4 fori per colonna riempimento con deviatore e kit doccia

Bain/douche 4 trous avec inverseur et Kit Douche pour remplissage ETP

CODE / COEFFICIENT | CODICE /
COEFFICIENTE | CODE / COEFFICIENT

| | | |
|------|---------|------|
| ● CC | BT397CC | 18,1 |
| ● PL | BT397PL | 29,0 |
| ● II | BT397II | 27,2 |
| ● RS | BT397RS | 27,2 |
| ● OO | BT397OO | 27,2 |

PACKAGING

L: 400 mm
D: 250 mm
H: 140 mm

3,9 kg

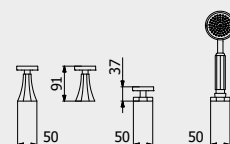

PORTATE | WATER FLOW | DÉBIT D'EAU

| | | |
|--------|--------|--------|
| 1 BAR | 2 BAR | 3 BAR |
| 19 l/m | 27 l/m | 33 l/m |

ARTICLE | ARTICOLO | ARTICLE

BL397



4 holes bath filler with overflow outlet connection, diverter and shower kit

Bordo vasca 4 fori per colonna riempimento con deviatore e kit doccia

Bain/douche 4 trous avec inverseur et Kit Douche pour remplissage ETP

CODE / COEFFICIENT | CODICE /
COEFFICIENTE | CODE / COEFFICIENT

| | | |
|------|---------|------|
| ● CC | BL397CC | 18,1 |
| ● PL | BL397PL | 29,0 |
| ● II | BL397II | 27,2 |
| ● RS | BL397RS | 27,2 |
| ● OO | BL397OO | 27,2 |

PACKAGING

L: 400 mm
D: 250 mm
H: 140 mm

3,9 kg

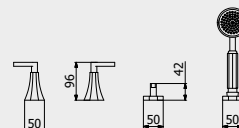

PORTATE | WATER FLOW | DÉBIT D'EAU

| | | |
|--------|--------|--------|
| 1 BAR | 2 BAR | 3 BAR |
| 19 l/m | 27 l/m | 33 l/m |



ARTICLE | ARTICOLO | ARTICLE

BT398



Five holes wall-mounted bath filler with shower kit
Bordo vasca a parete cinque fori con deviatore e kit doccia
Bain/douche cinq trous avec inverseur et Kit Douche

| CODE / COEFFICIENT CODICE / COEFFICIENTE | |
|--|------|
| ● CC BT398CC | 19,3 |
| ● PL BL398PL | 30,9 |
| ● II BT398II | 29,0 |
| ● RS BL398RS | 29,0 |
| ● OO BT398OO | 29,0 |

PACKAGING

| | |
|----|-----------|
| 📦 | L: 150 mm |
| | D: 190 mm |
| | H: 98 mm |
| ⚖️ | 2,6 kg |

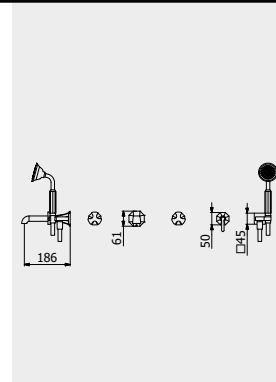

PORTATE | WATER FLOW | DÉBIT D'EAU

| | | |
|----------|----------|----------|
| 1 BAR | 2 BAR | 3 BAR |
| 12,3 l/m | 17,5 l/m | 21,8 l/m |

ARTICLE | ARTICOLO | ARTICLE

BL398



Five holes wall-mounted bath filler with shower kit
Bordo vasca a parete cinque fori con deviatore e kit doccia
Bain/douche cinq trous avec inverseur et Kit Douche

| CODE / COEFFICIENT CODICE / COEFFICIENTE | |
|--|------|
| ● CC BL398CC | 19,3 |
| ● PL BL398PL | 30,9 |
| ● II BL398II | 29,0 |
| ● RS BL398RS | 29,0 |
| ● OO BL398OO | 29,0 |

PACKAGING

| | |
|----|-----------|
| 📦 | L: 150 mm |
| | D: 190 mm |
| | H: 98 mm |
| ⚖️ | 2,6 kg |

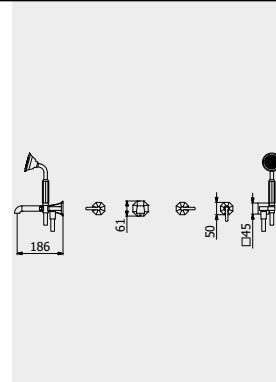

PORTATE | WATER FLOW | DÉBIT D'EAU

| | | |
|----------|----------|----------|
| 1 BAR | 2 BAR | 3 BAR |
| 12,3 l/m | 17,5 l/m | 21,8 l/m |

ARTICLE | ARTICOLO | ARTICLE

BT700



Free-standing two columns bath filler with shower kit
Bordo vasca da terra a doppia colonna con kit doccia
Mélangeur bain/douche complet avec alimentation sol

| CODE / COEFFICIENT CODICE / COEFFICIENTE | |
|--|------|
| ● CC BT700CC | 50,4 |
| ● PL BT700PL | 80,6 |
| ● II BT700II | 75,6 |
| ● RS BT700RS | 75,6 |
| ● OO BT700OO | 75,6 |

PACKAGING

| | |
|----|-----------|
| 📦 | L: 360 mm |
| | D: 220 mm |
| | H: 220 mm |
| ⚖️ | 10,5 kg |

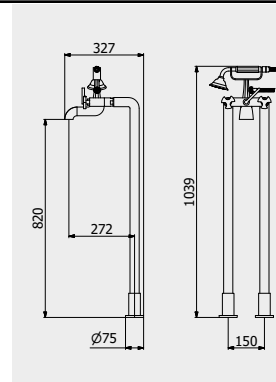

PORTATE | WATER FLOW | DÉBIT D'EAU

| | | |
|--------|----------|----------|
| 1 BAR | 2 BAR | 3 BAR |
| 35 l/m | 45,8 l/m | 69,3 l/m |

ARTICLE | ARTICOLO | ARTICLE

BL700



Free-standing two columns bath filler with shower kit
Bordo vasca da terra a doppia colonna con kit doccia
Mélangeur bain/douche complet avec alimentation sol

| CODE / COEFFICIENT CODICE / COEFFICIENTE | |
|--|------|
| ● CC BL700CC | 50,4 |
| ● PL BL700PL | 80,6 |
| ● II BL700II | 75,6 |
| ● RS BL700RS | 75,6 |
| ● OO BL700OO | 75,6 |

PACKAGING

| | |
|----|-----------|
| 📦 | L: 360 mm |
| | D: 220 mm |
| | H: 220 mm |
| ⚖️ | 10,5 kg |

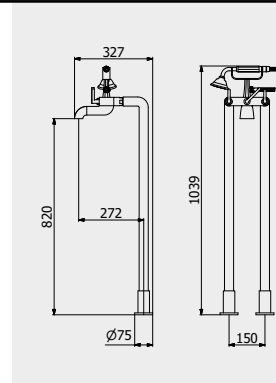

PORTATE | WATER FLOW | DÉBIT D'EAU

| | | |
|--------|----------|----------|
| 1 BAR | 2 BAR | 3 BAR |
| 35 l/m | 45,8 l/m | 69,3 l/m |

ARTICLE | ARTICOLO | ARTICLE

BL706



Exposed parts for bidet spray complete with mixer

Set di parti esterne per Idroscopino igienico con miscelatore

Partie extérieure pour douchette hygiénique avec mitigeur



| CODE / COEFFICIENT | CODICE / COEFFICIENTE | CODE / COEFFICIENT |
|--------------------|-----------------------|--------------------|
| ● CC | EBL706CC | 12,5 |
| ● PL | EBL706PL | 20,0 |
| ● II | EBL706II | 18,8 |
| ● RS | EBL706RS | 18,8 |
| ● OO | EBL706OO | 18,8 |

PACKAGING

| | |
|--|-----------|
| | L: 370 mm |
| | D: 270 mm |
| | H: 80 mm |
| | 3,1 kg |

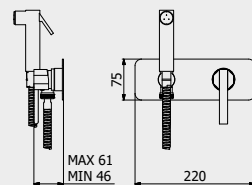

PORTATE | WATER FLOW | DÉBIT D'EAU

| | | |
|---------|---------|-------|
| 1 BAR | 2 BAR | 3 BAR |
| 2,3 l/m | 3,2 l/m | 4 l/m |

Built-in body to be purchased separately

Corpo incasso da acquistare separatamente

Corps intégré à acheter séparément



CODICE | CODE | CODE

INC206XXXN_19

COEFFICIENTE | COEFFICIENT | COEFFICIENT

2,9



ARTICLE | ARTICOLO | ARTICLE

SH045

Duplex Belmondo

Duplex Belmondo

Duplex Belmondo



CODE / COEFFICIENT | CODICE / COEFFICIENTE

| CODE / COEFFICIENT | CODICE / COEFFICIENTE | CODE / COEFFICIENT |
|--------------------|-----------------------|--------------------|
| ● CC | SH045CC | 6,1 |
| ● OO | SH045OO | 9,1 |
| ● II | SH045II | 9,1 |
| ● RS | SH045RS | 9,1 |
| ● PL | SH045PL | 9,8 |

PACKAGING

| | |
|--|-----------|
| | L: 280 mm |
| | D: 130 mm |
| | H: 70 mm |
| | 1,7 kg |

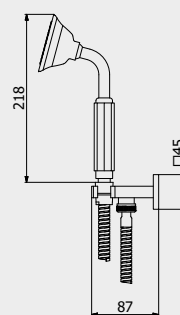

PORTATE | WATER FLOW | DÉBIT D'EAU

| | | |
|----------|----------|--------|
| 1 BAR | 2 BAR | 3 BAR |
| 15,5 l/m | 23,2 l/m | 30 l/m |

BELMONDO / ACCESSORIES COLLECTION

ARTICLE | ARTICOLO | ARTICLE

BL001

Wall soap-holder

Porta sapone a muro

Porte savon encastré



CODE / COEFFICIENT | CODICE / COEFFICIENTE

| CODE / COEFFICIENT | CODICE / COEFFICIENTE | CODE / COEFFICIENT |
|--------------------|-----------------------|--------------------|
| ● CC | BL001CC | 6,2 |
| ● PL | BL001PL | 9,9 |
| ● II | BL001II | 9,3 |
| ● RS | BL001RS | 9,3 |
| ● OO | BL001OO | 9,3 |

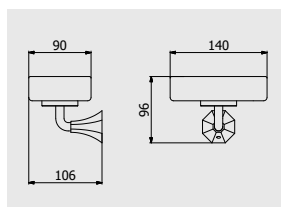

PACKAGING

| | | | |
|--|-----------|--|--------|
| | L: 150 mm | | 0,6 kg |
| | D: 190 mm | | |
| | H: 98 mm | | |

ARTICLE | ARTICOLO | ARTICLE

BL003

Wall toothbrush holder

Bicchiera porta spazzolino a parete

Porte-verre en verre gravé



CODE / COEFFICIENT | CODICE / COEFFICIENTE

| CODE / COEFFICIENT | CODICE / COEFFICIENTE | CODE / COEFFICIENT |
|--------------------|-----------------------|--------------------|
| ● CC | BL003CC | 5,3 |
| ● PL | BL003PL | 8,5 |
| ● II | BL003II | 8,0 |
| ● RS | BL003RS | 8,0 |
| ● OO | BL003OO | 8,0 |

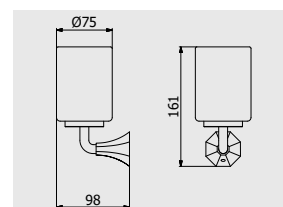

PACKAGING

| | | | |
|--|-----------|--|--------|
| | L: 180 mm | | 0,6 kg |
| | D: 180 mm | | |
| | H: 100 mm | | |



ARTICLE | ARTICOLO | ARTICLE

BL008



Robe Hook
Appendino a parete
Cintre

| CODE / COEFFICIENT | CODICE / COEFFICIENTE | CODE / COEFFICIENT |
|--------------------|-----------------------|--------------------|
| CC | BL008CC | 2,9 |
| PL | BL008PL | 4,6 |
| II | BL008II | 4,4 |
| RS | BL008RS | 4,4 |
| OO | BL008OO | 4,4 |

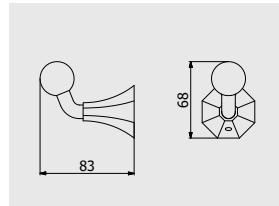

PACKAGING

L: 150 mm
D: 190 mm
H: 98 mm
0,3 kg

ARTICLE | ARTICOLO | ARTICLE

BL007



Ring Towel holder
Porta salvietta ad anello
Porte-serviette anneau

| CODE / COEFFICIENT | CODICE / COEFFICIENTE | CODE / COEFFICIENT |
|--------------------|-----------------------|--------------------|
| CC | BL007CC | 4,1 |
| PL | BL007PL | 6,6 |
| II | BL007II | 6,2 |
| RS | BL007RS | 6,2 |
| OO | BL007OO | 6,2 |

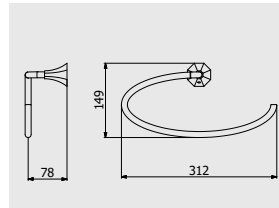

PACKAGING

L: 425 mm
D: 188 mm
H: 98 mm
1,0 kg

ARTICLE | ARTICOLO | ARTICLE

BL006



Towel holder
Porta salvietta
Porte-serviette

| CODE / COEFFICIENT | CODICE / COEFFICIENTE | CODE / COEFFICIENT |
|--------------------|-----------------------|--------------------|
| CC | BL006CC | 4,6 |
| PL | BL006PL | 7,4 |
| II | BL006II | 6,9 |
| RS | BL006RS | 6,9 |
| OO | BL006OO | 6,9 |

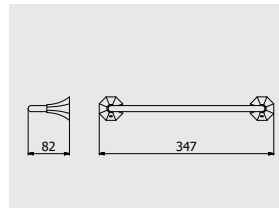

PACKAGING

L: 540 mm
D: 130 mm
H: 70 mm
0,9 kg

ARTICLE | ARTICOLO | ARTICLE

BL010



Shelf
Mensola
Etagère

| CODE / COEFFICIENT | CODICE / COEFFICIENTE | CODE / COEFFICIENT |
|--------------------|-----------------------|--------------------|
| CC | BL010CC | 3,9 |
| PL | BL010PL | 6,2 |
| II | BL010II | 5,9 |
| RS | BL010RS | 5,9 |
| OO | BL010OO | 5,9 |

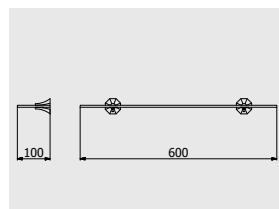

PACKAGING

L: 720 mm
D: 130 mm
H: 70 mm
1,3 kg

ARTICLE | ARTICOLO | ARTICLE

BL011



Toilet paper holder
Porta rotolo
Porte rouleaux de toilette

| CODE / COEFFICIENT | CODICE / COEFFICIENTE | CODE / COEFFICIENT |
|--------------------|-----------------------|--------------------|
| CC | BL011CC | 1,9 |
| PL | BL011PL | 3,0 |
| II | BL011II | 2,9 |
| RS | BL011RS | 2,9 |
| OO | BL011OO | 2,9 |

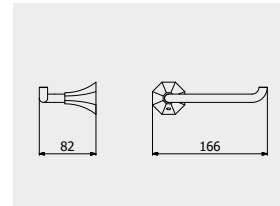

PACKAGING

L: 175 mm
D: 125 mm
H: 90 mm
0,4 kg

ARTICLE | ARTICOLO | ARTICLE

BL004



Towel holder
Porta salvietta
Porte-serviette

| CODE / COEFFICIENT | CODICE / COEFFICIENTE | CODE / COEFFICIENT |
|--------------------|-----------------------|--------------------|
| CC | BL004CC | 5,5 |
| PL | BL004PL | 8,8 |
| II | BL004II | 8,3 |
| RS | BL004RS | 8,3 |
| OO | BL004OO | 8,3 |

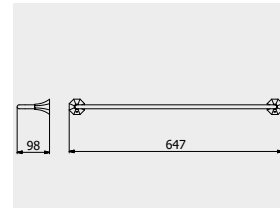

PACKAGING

L: 720 mm
D: 130 mm
H: 70 mm
1,2 kg

ARTICLE | ARTICOLO | ARTICLE

BL014



Towel holder
Porta salvietta
Porte-serviette

| CODE / COEFFICIENT | CODICE / COEFFICIENTE | CODE / COEFFICIENT |
|--------------------|-----------------------|--------------------|
| CC | BL014CC | 5,3 |
| PL | BL014PL | 8,5 |
| II | BL014II | 8,0 |
| RS | BL014RS | 8,0 |
| OO | BL014OO | 8,0 |

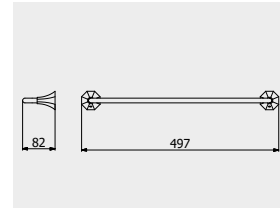

PACKAGING

L: 540 mm
D: 130 mm
H: 70 mm
1,0 kg

ARTICLE | ARTICOLO | ARTICLE

BL012



Toilet brush holder
Porta scopino da terra
Porte balayette au sol

| CODE / COEFFICIENT | CODICE / COEFFICIENTE | CODE / COEFFICIENT |
|--------------------|-----------------------|--------------------|
| CC | BL012CC | 5,2 |
| PL | BL012PL | 8,3 |
| II | BL012II | 7,8 |
| RS | BL012RS | 7,8 |
| OO | BL012OO | 7,8 |

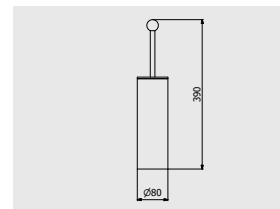

PACKAGING

L: 425 mm
D: 188 mm
H: 98 mm
1,0 kg

WAVE

Sinuuous and rounded shapes, providing pleasure and a touch of surprise.

Forme sinuose e arrotondate che regalano piacere e un tocco di sorpresa.
Formes sinueuses et arrondies qui donnent plaisir et une touche de surprise.

Sinuuous and rounded shapes, interspaced with more angular lines on the top, providing emotions, pleasure and a touch of surprise. The WAVE collection is a perfect balance between functionality and style, and testifies Marco Acerbis' approach to design. The sinuous body of the faucet is opposed to the resolute and pronounced lines of the lever just above, with a slightly inclined aerator to avoid splashing. The form becomes function and the function becomes form, in an unusual and exciting harmony.

Forme sinuose e arrotondate, intervallate da linee più squadrate nella parte superiore, che regalano emozione, piacere e un tocco di sorpresa. La serie WAVE è un perfetto equilibrio tra funzionalità e stile, e testimonia l'approccio di Marco Acerbis al design. Il flessuoso corpo del rubinetto lascia il posto poco più in alto ai tratti decisi e prominenti della leva e a un aeratore leggermente inclinato per evitare gli schizzi. La forma diventa funzione e la funzione si fa forma, in un bilanciamento inusuale e stimolante.

Formes sinueuses et arrondies, entrecoupées par des lignes plus carrées au sommet, qui donnent émotion, plaisir et une touche de surprise. La collection WAVE est un équilibre parfait entre fonctionnalité et style, et elle est témoin de l'approche de Marco Acerbis au design. Le corps sinueux du robinet laisse la place aux traits résolus et saillants du levier juste au-dessus, et à un aérateur légèrement incliné pour éviter les éclaboussures. La forme devient fonction et la fonction devient forme, dans un équilibre inédit et stimulant.



ANTI-LIMESCALE



CRYSTAL CLEAR
WATER



LEAD FREE



ZINC FREE





Wave

DESIGN
MARCO ACERBIS

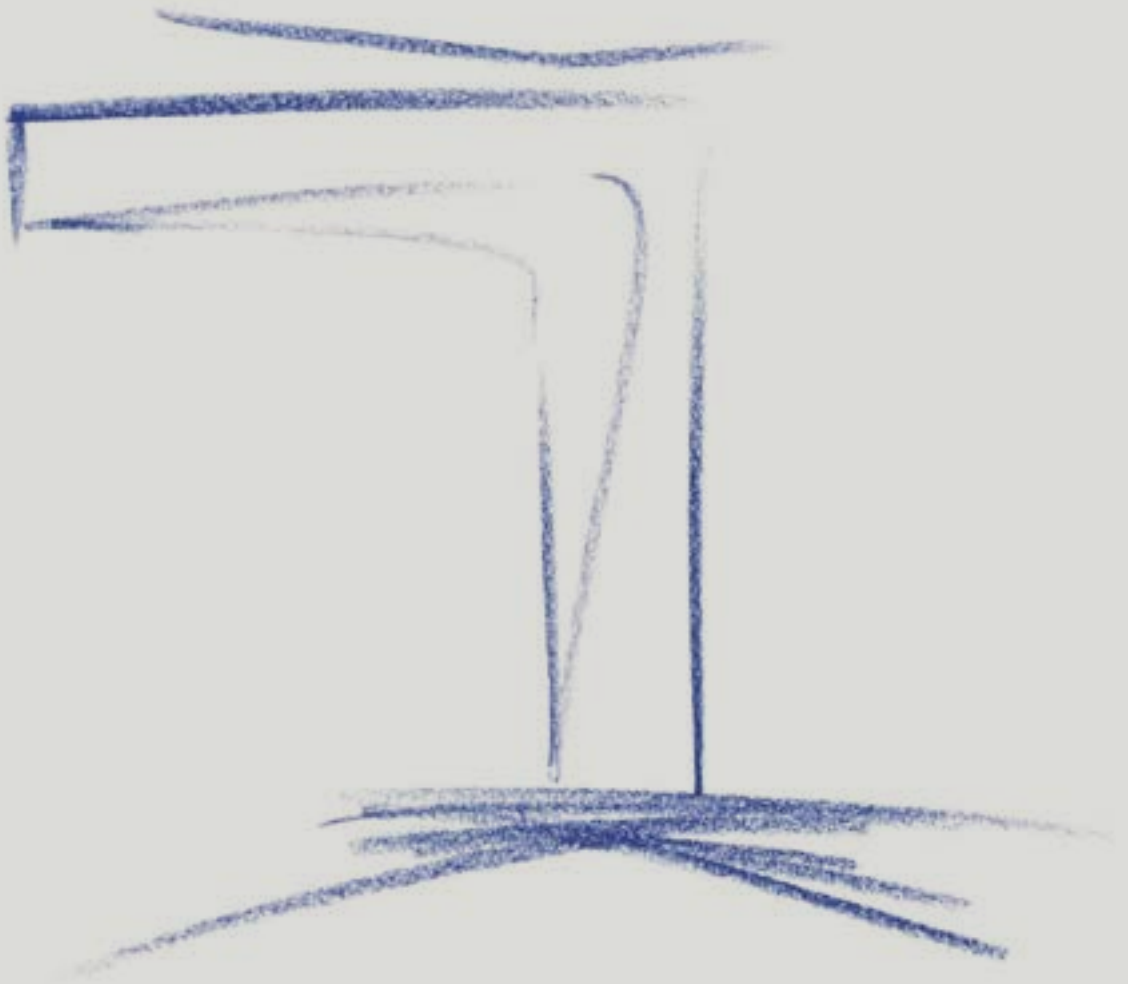

“ The WAVE faucet, with its curvy and square shapes, fully attests my approach to design: the constant search for the perfect balance between the function, inherent in the object, and the aesthetic element, which must be able to excite and surprise.

Il rubinetto WAVE, con le sue forme a tratti sinuose e squadrate, testimonia appieno il mio approccio al design: la costante ricerca del perfetto equilibrio tra funzione, connaturata all'oggetto, e componente estetica, che deve saper emozionare e sorprendere.

Le robinet WAVE, aux formes sinueuses et carrées au même temps, témoigne pleinement mon approche au design: la recherche constante d'un équilibre parfait entre la fonction inhérente à l'objet et la composante esthétique, qui doit exciter et surprendre.

”





Wave

↑ WA200CC
Monohole washbasin mixer
Miscelatore lavabo monoforo
Mitigeur lavabo complet

← WA200CC
Monohole washbasin mixer
Miscelatore lavabo monoforo
Mitigeur lavabo complet

→ WA202CC
Tall monohole washbasin mixer
Miscelatore lavabo monoforo alto
Mitigeur lavabo haut







Wave

- ← WA206CC
Wall mounted washbasin mixer
Miscelatore lavabo due fori a parete
Mitigeur lavabo mural
- WA220CC
Monohole bidet mixer
Miscelatore bidet monoforo
Mitigeur bidet complet





- ← **WA314CC**
Three ways wall shower mixer complete with shower kit
 Miscelatore doccia a parete con deviatore tre vie e doccia integrato
 Mitigeur douche mural trois voies avec inverseur et douchette encastrée

- ↙ **WA350CC**
Wall mounted shower mixer with shower kit
 Doccia esterno a parete completo di kit doccia
 Mitigeur de douche externe avec flexible et douchette

- **WA313CC**
Two ways wall shower mixer complete with shower kit
 Miscelatore doccia a parete con deviatore due vie e doccia integrato
 Mitigeur douche mural deux voies avec inverseur et douchette encastrée









Wave

← **WA250CC**
Wall mounted bath filler with hand shower kit
Bordo vasca esterno a parete con kit doccia
Mitigeur bain/douche mural avec douchette
encastrée

↑ **WA320CC**
Wall mounted spout
Bocca d'erogazione a parete
Bec de remplissage mural

→ **WA318CC**
Built-in wall mounted waterfall spout
Cascata a parete con erogazione a lama esterna
Cascade murale avec bec externe





↖ WA399CC
→ Free-standing bath filler with shower kit
Bordo vasca da terra con kit doccia
Bain douche complet alimentation au sol

← WA740CC
Two holes deck mounted bath filler mixer
with shower kit
Miscelatore Bordo vasca da appoggio due fori
con doccia
Mitigeur Bain/douche deux trous avec
douchette



Wave

ARTICLE | ARTICOLO | ARTICLE

WA200



Monohole washbasin mixer complete with drain

Miscelatore lavabo monoforo completo di scarico automatico

Mitigeur lavabo complet avec bonde automatique

CODE / COEFFICIENT | CODICE /
COEFFICIENTE | CODE / COEFFICIENT

| | | | |
|---|----|---------|------|
| ● | CC | WA200CC | 6,5 |
| ● | SS | WA200SS | 8,1 |
| ● | BO | WA200BO | 7,8 |
| ● | NP | WA200NP | 7,8 |
| ● | CF | WA200CF | 9,8 |
| ● | CS | WA200CS | 10,4 |
| ● | II | WA200II | 9,8 |
| ● | IS | WA200IS | 10,4 |
| ● | RS | WA200RS | 9,8 |
| ● | SR | WA200SR | 10,4 |
| ● | OO | WA200OO | 9,8 |
| ● | OS | WA200OS | 10,4 |

PACKAGING

 L: 340 mm
D: 180 mm
H: 70 mm

1,9 kg

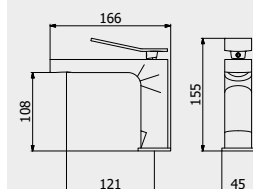

PORTATE | WATER FLOW | DÉBIT D'EAU

| | | |
|-------|--------|----------|
| 1 BAR | 2 BAR | 3 BAR |
| 7 l/m | 10 l/m | 12,5 l/m |

ARTICLE | ARTICOLO | ARTICLE

WA204



Mid-size monohole washbasin mixer complete with drain

Miscelatore lavabo monoforo medio completo di scarico automatico

Mitigeur lavabo moyen complet avec bonde automatique

CODE / COEFFICIENT | CODICE /
COEFFICIENTE | CODE / COEFFICIENT

| | | | |
|---|----|---------|------|
| ● | CC | WA204CC | 8,8 |
| ● | SS | WA204SS | 11,0 |
| ● | BO | WA204BO | 10,6 |
| ● | NP | WA204NP | 10,6 |
| ● | CF | WA204CF | 13,2 |
| ● | CS | WA204CS | 14,1 |
| ● | II | WA204II | 13,2 |
| ● | IS | WA204IS | 14,1 |
| ● | RS | WA204RS | 13,2 |
| ● | SR | WA204SR | 14,1 |
| ● | OO | WA204OO | 13,2 |
| ● | OS | WA204OS | 14,1 |

PACKAGING

 L: 370 mm
D: 270 mm
H: 80 mm

2,2 kg

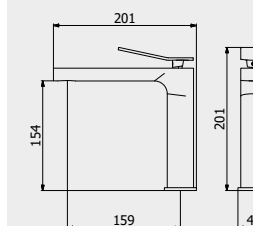

PORTATE | WATER FLOW | DÉBIT D'EAU

| | | |
|-------|--------|----------|
| 1 BAR | 2 BAR | 3 BAR |
| 7 l/m | 10 l/m | 12,5 l/m |

ARTICLE | ARTICOLO | ARTICLE

WA202



Tall monohole washbasin mixer complete with drain

Miscelatore lavabo monoforo alto completo di scarico automatico

Mitigeur lavabo haut complet avec bonde automatique

CODE / COEFFICIENT | CODICE /
COEFFICIENTE | CODE / COEFFICIENT

| | | | |
|---|----|---------|------|
| ● | CC | WA202CC | 9,5 |
| ● | SS | WA202SS | 11,9 |
| ● | BO | WA202BO | 11,4 |
| ● | NP | WA202NP | 11,4 |
| ● | CF | WA202CF | 14,3 |
| ● | CS | WA202CS | 15,2 |
| ● | II | WA202II | 14,3 |
| ● | IS | WA202IS | 15,2 |
| ● | RS | WA202RS | 14,3 |
| ● | SR | WA202SR | 15,2 |
| ● | OO | WA202OO | 14,3 |
| ● | OS | WA202OS | 15,2 |

PACKAGING

 L: 370 mm
D: 270 mm
H: 80 mm

3,0 kg

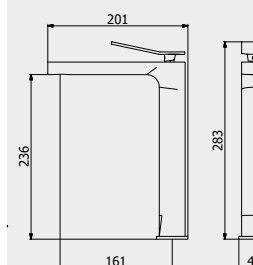

PORTATE | WATER FLOW | DÉBIT D'EAU

| | | |
|-------|--------|----------|
| 1 BAR | 2 BAR | 3 BAR |
| 7 l/m | 10 l/m | 12,5 l/m |



ARTICLE | ARTICOLO | ARTICLE

WA206



Wall mounted washbasin mixer complete with drain
 Miscelatore lavabo due fori a parete completo di scarico automatico
 Mitigeur lavabo mural complet avec bonde automatique

| CODE / COEFFICIENT | CODICE / COEFFICIENTE | COEFFICIENT |
|--------------------|-----------------------|-------------|
| CC | EWA206CC | 8,8 |
| SS | EWA206SS | 11,0 |
| BO | EWA206BO | 10,6 |
| NP | EWA206NP | 10,6 |
| CF | EWA206CF | 13,2 |
| CS | EWA206CS | 14,1 |
| II | EWA206II | 13,2 |
| IS | EWA206IS | 14,1 |
| RS | EWA206RS | 13,2 |
| SR | EWA206SR | 14,1 |
| OO | EWA206OO | 13,2 |
| OS | EWA206OS | 14,1 |

PACKAGING

L: 265 mm
 D: 260 mm
 H: 70 mm
 1,7 kg

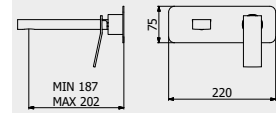

PORTATE | WATER FLOW | DÉBIT D'EAU

| 1 BAR | 2 BAR | 3 BAR |
|----------|----------|----------|
| 12,2 l/m | 17,4 l/m | 21,4 l/m |

Built-in body to be purchased separately

Corpo incasso da acquistare separatamente
 Corps intégré à acheter séparément



CODICE | CODE | CODE

INC206XXXN_19

COEFFICIENTE | COEFFICIENT | COEFFICIENT

2,9

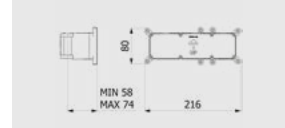

Wave

ARTICLE | ARTICOLO | ARTICLE

WA210



Ceiling spout with wall mounted mixer
 Bocca da soffitto con comando remoto ad incasso
 Mitigeur lavabo mural avec bec plafond complet avec bonde automatique

| CODE / COEFFICIENT | CODICE / COEFFICIENTE | COEFFICIENT |
|--------------------|-----------------------|-------------|
| CC | EWA210CC | 33,8 |
| SS | EWA210SS | 42,3 |
| BO | EWA210BO | 40,6 |
| NP | EWA210NP | 40,6 |

PACKAGING

L: 150 mm
 D: 190 mm
 H: 98 mm
 L: 1700 mm
 Ø: 70 mm
 4,5 kg

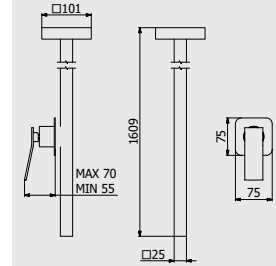

PORTATE | WATER FLOW | DÉBIT D'EAU

| 1 BAR | 2 BAR | 3 BAR |
|---------|---------|-------|
| 4,3 l/m | 5,2 l/m | 7 l/m |

Built-in body to be purchased separately

Corpo incasso da acquistare separatamente
 Corps intégré à acheter séparément



CODICE | CODE | CODE

INC300XXXN_19

COEFFICIENTE | COEFFICIENT | COEFFICIENT

1,8

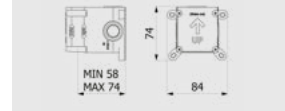

ARTICLE | ARTICOLO | ARTICLE

WA299



Monohole free-standing washbasin mixer complete with drain
 Miscelatore lavabo da terra completo di scarico automatico
 Mitigeur lavabo free standing complet avec bonde automatique

| CODE / COEFFICIENT | CODICE / COEFFICIENTE | COEFFICIENT |
|--------------------|-----------------------|-------------|
| CC | EWA299CC | 31,9 |
| SS | EWA299SS | 39,9 |
| BO | EWA299BO | 38,3 |
| NP | EWA299NP | 38,3 |
| CF | EWA299CF | 47,9 |
| CS | EWA299CS | 51,0 |
| II | EWA299II | 47,9 |
| IS | EWA299IS | 51,0 |
| RS | EWA299RS | 47,9 |
| SR | EWA299SR | 51,0 |
| OO | EWA299OO | 47,9 |
| OS | EWA299OS | 51,0 |

PACKAGING

L: 1160 mm
 D: 360 mm
 H: 180 mm
 14,5 kg

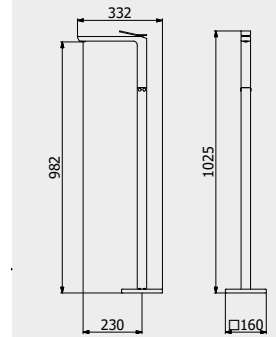

PORTATE | WATER FLOW | DÉBIT D'EAU

| 1 BAR | 2 BAR | 3 BAR |
|---------|---------|---------|
| 3,6 l/m | 5,1 l/m | 5,5 l/m |

Built-in body to be purchased separately
 AVAILABLE FROM JANUARY 2020

Corpo incasso da acquistare separatamente
 DISPONIBILE DA GENNAIO 2020
 Corps intégré à acheter séparément
 DISPONIBLE À PARTIR DE JANVIER 2020



CODICE | CODE | CODE

INC399XXXN_19

COEFFICIENTE | COEFFICIENT | COEFFICIENT

2,8

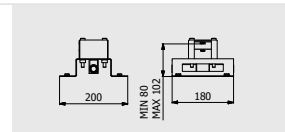

ARTICLE | ARTICOLO | ARTICLE

WA220



Monohole bidet mixer complete with drain

Miscelatore bidet monoforo completo di scarico automatico

Mitigeur bidet complet avec bonde automatique

CODE / COEFFICIENT | CODICE /
COEFFICIENTE | CODE / COEFFICIENT

| | | |
|----|---------|------|
| CC | WA220CC | 6,5 |
| SS | WA220SS | 8,1 |
| BO | WA220BO | 7,8 |
| NP | WA220NP | 7,8 |
| CF | WA220CF | 9,8 |
| CS | WA220CS | 10,4 |
| II | WA220II | 9,8 |
| IS | WA220IS | 10,4 |
| RS | WA220RS | 9,8 |
| SR | WA220SR | 10,4 |
| OO | WA220OO | 9,8 |
| OS | WA220OS | 10,4 |

PACKAGING

L: 340 mm
D: 180 mm
H: 70 mm

1,7 kg

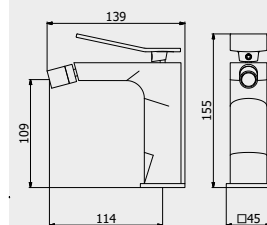

PORTATE | WATER FLOW | DÉBIT D'EAU

| | | |
|-------|--------|----------|
| 1 BAR | 2 BAR | 3 BAR |
| 7 l/m | 10 l/m | 12,5 l/m |

ARTICLE | ARTICOLO | ARTICLE

WA300



Exposed parts for manual wall mixer

Set di parti esterne per miscelatore a parete ad una via

Partie extérieure pour mitigeur encastré à une voie

CODE / COEFFICIENT | CODICE /
COEFFICIENTE | CODE / COEFFICIENT

| | | |
|----|----------|-----|
| CC | EWA300CC | 4,1 |
| SS | EWA300SS | 5,1 |
| BO | EWA300BO | 4,9 |
| NP | EWA300NP | 4,9 |
| CF | EWA300CF | 6,2 |
| CS | EWA300CS | 6,6 |
| II | EWA300II | 6,2 |
| IS | EWA300IS | 6,6 |
| RS | EWA300RS | 6,2 |
| SR | EWA300SR | 6,6 |
| OO | EWA300OO | 6,2 |
| OS | EWA300OS | 6,6 |

PACKAGING

L: 150 mm
D: 190 mm
H: 98 mm

1,7 kg

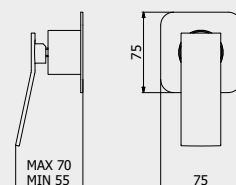

PORTATE | WATER FLOW | DÉBIT D'EAU

| | | |
|----------|----------|----------|
| 1 BAR | 2 BAR | 3 BAR |
| 13,3 l/m | 18,7 l/m | 22,6 l/m |

Built-in body to be purchased separately

Corpo incasso da acquistare separatamente

Corps intégré à acheter séparément



CODICE | CODE | CODE

INC300XXXN_19

COEFFICIENTE | COEFFICIENT | COEFFICIENT

1,8



ARTICLE | ARTICOLO | ARTICLE

WA310



Exposed parts for manual wall mixer with two ways diverter

Miscelatore doccia a parete con deviatore due vie

Mitigeur douche mural deux voies avec inverseur

CODE / COEFFICIENT | CODICE /
COEFFICIENTE | CODE / COEFFICIENT

| | | |
|----|----------|-----|
| CC | EWA310CC | 6,1 |
| SS | EWA310SS | 7,6 |
| BO | EWA310BO | 7,3 |
| NP | EWA310NP | 7,3 |
| CF | EWA310CF | 9,2 |
| CS | EWA310CS | 9,8 |
| II | EWA310II | 9,2 |
| IS | EWA310IS | 9,8 |
| RS | EWA310RS | 9,2 |
| SR | EWA310SR | 9,8 |
| OO | EWA310OO | 9,2 |
| OS | EWA310OS | 9,8 |

PACKAGING

L: 150 mm
D: 190 mm
H: 98 mm

1,7 kg

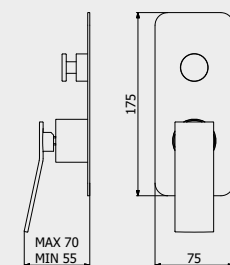

PORTATE | WATER FLOW | DÉBIT D'EAU

| | | |
|---------|----------|----------|
| 1 BAR | 2 BAR | 3 BAR |
| 9,8 l/m | 13,7 l/m | 16,6 l/m |

Built-in body to be purchased separately

Corpo incasso da acquistare separatamente

Corps intégré à acheter séparément



CODICE | CODE | CODE

INC310XXXN_19

COEFFICIENTE | COEFFICIENT | COEFFICIENT

3,3

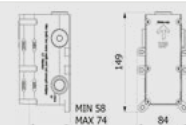

ARTICLE | ARTICOLO | ARTICLE

WA312



Exposed parts for manual wall mixer with three ways diverter
Set di parti esterne per miscelatore a parete a tre vie
Mitigeur douche mural trois voies avec inverseur

| CODE / COEFFICIENT | CODICE / COEFFICIENTE | COEFFICIENT |
|--------------------|-----------------------|-------------|
| CC | EWA312CC | 7,4 |
| SS | EWA312SS | 9,3 |
| BO | EWA312BO | 8,9 |
| NP | EWA312NP | 8,9 |
| CF | EWA312CF | 11,1 |
| CS | EWA312CS | 11,8 |
| II | EWA312II | 11,1 |
| IS | EWA312IS | 11,8 |
| RS | EWA312RS | 11,1 |
| SR | EWA312SR | 11,8 |
| OO | EWA312OO | 11,1 |
| OS | EWA312OS | 11,8 |

PACKAGING

L: 150 mm
D: 190 mm
H: 98 mm
1,7 kg

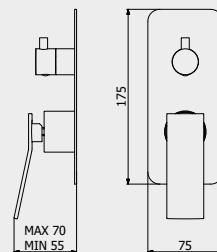

PORTATE | WATER FLOW | DÉBIT D'EAU

| | | |
|---------|----------|----------|
| 1 BAR | 2 BAR | 3 BAR |
| 8,3 l/m | 11,7 l/m | 14,3 l/m |

Built-in body to be purchased separately

Corpo incasso da acquistare separatamente
Corps intégré à acheter séparément



CODICE | CODE | CODE

INC312XXXN_19

COEFFICIENTE | COEFFICIENT | COEFFICIENT

3,3

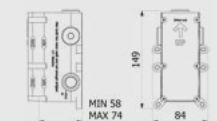

Wave

ARTICLE | ARTICOLO | ARTICLE

WA313



Exposed parts for manual wall mixer with 2 ways with shower kit
Set di parti esterne per miscelatore a parete a due vie completo di kit doccia
Partie extérieure pour mitigeur encastré à deux voies avec douchette

| CODE / COEFFICIENT | CODICE / COEFFICIENTE | COEFFICIENT |
|--------------------|-----------------------|-------------|
| CC | EWA313CC | 10,2 |
| SS | EWA313SS | 12,8 |
| BO | EWA313BO | 12,2 |
| NP | EWA313NP | 12,2 |
| CF | EWA313CF | 15,3 |
| CS | EWA313CS | 16,3 |
| II | EWA313II | 15,3 |
| IS | EWA313IS | 16,3 |
| RS | EWA313RS | 15,3 |
| SR | EWA313SR | 16,3 |
| OO | EWA313OO | 15,3 |
| OS | EWA313OS | 16,3 |

PACKAGING

L: 370 mm
D: 270 mm
H: 80 mm
2,1 kg

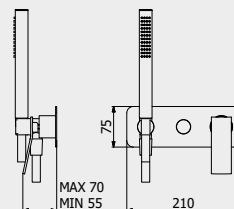

PORTATE | WATER FLOW | DÉBIT D'EAU

| | | |
|---------|----------|----------|
| 1 BAR | 2 BAR | 3 BAR |
| 9,8 l/m | 13,7 l/m | 16,6 l/m |

Built-in body to be purchased separately

Corpo incasso da acquistare separatamente
Corps intégré à acheter séparément



CODICE | CODE | CODE

INC313XXXN_19

COEFFICIENTE | COEFFICIENT | COEFFICIENT

3,6



ARTICLE | ARTICOLO | ARTICLE

WA314



Exposed parts for manual wall mixer with 3 ways with shower kit
Set di parti esterne per miscelatore a parete a tre vie completo di kit doccia
Partie extérieure pour mitigeur encastré à trois voies avec douchette

| CODE / COEFFICIENT | CODICE / COEFFICIENTE | COEFFICIENT |
|--------------------|-----------------------|-------------|
| CC | EWA314CC | 11,6 |
| SS | EWA314SS | 14,5 |
| BO | EWA314BO | 13,9 |
| NP | EWA314NP | 13,9 |
| CF | EWA314CF | 17,4 |
| CS | EWA314CS | 18,6 |
| II | EWA314II | 17,4 |
| IS | EWA314IS | 18,6 |
| RS | EWA314RS | 17,4 |
| SR | EWA314SR | 18,6 |
| OO | EWA314OO | 17,4 |
| OS | EWA314OS | 18,6 |

PACKAGING

L: 370 mm
D: 270 mm
H: 80 mm
2,1 kg

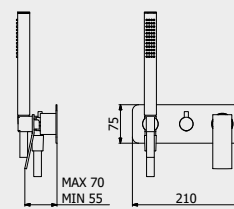

PORTATE | WATER FLOW | DÉBIT D'EAU

| | | |
|---------|----------|----------|
| 1 BAR | 2 BAR | 3 BAR |
| 8,3 l/m | 11,7 l/m | 14,3 l/m |

Built-in body to be purchased separately

Corpo incasso da acquistare separatamente
Corps intégré à acheter séparément



CODICE | CODE | CODE

INC314XXXN_19

COEFFICIENTE | COEFFICIENT | COEFFICIENT

3,7



ARTICLE | ARTICOLO | ARTICLE

RU318



Built-in wall mounted waterfall spout

Cascata a parete con erogazione a lama esterna

Cascade murale avec bec externe

CODE / COEFFICIENT | CODICE /
COEFFICIENTE | CODE / COEFFICIENT

| | | |
|------|---------|------|
| ● CC | RU318CC | 22,9 |
| ● SS | RU318SS | 28,6 |
| ● BO | RU318BO | 27,5 |
| ● NP | RU318NP | 27,5 |
| ● CF | RU318CF | 34,4 |
| ● CS | RU318CS | 36,6 |
| ● II | RU318II | 34,4 |
| ● IS | RU318IS | 36,6 |
| ● RS | RU318RS | 34,4 |
| ● SR | RU318SR | 36,6 |
| ● OO | RU318OO | 34,4 |
| ● OS | RU318OS | 36,6 |

PACKAGING

 L: 340 mm
D: 180 mm
H: 70 mm

4,0 kg

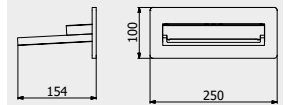

PORTATE | WATER FLOW | DÉBIT D'EAU

| | | |
|--------|--------|--------|
| 1 BAR | 2 BAR | 3 BAR |
| 13 l/m | 17 l/m | 20 l/m |

ARTICLE | ARTICOLO | ARTICLE

RU319



Wall mounted waterfall

Cascata a parete con erogazione diretta

Cascade murale

CODE / COEFFICIENT | CODICE /
COEFFICIENTE | CODE / COEFFICIENT

| | | |
|------|---------|------|
| ● CC | RU319CC | 12,8 |
| ● SS | RU319SS | 16,0 |
| ● BO | RU319BO | 15,4 |
| ● NP | RU319NP | 15,4 |
| ● CF | RU319CF | 19,2 |
| ● CS | RU319CS | 20,5 |
| ● II | RU319II | 19,2 |
| ● IS | RU319IS | 20,5 |
| ● RS | RU319RS | 19,2 |
| ● SR | RU319SR | 20,5 |
| ● OO | RU319OO | 19,2 |
| ● OS | RU319OS | 20,5 |

PACKAGING

 L: 340 mm
D: 180 mm
H: 70 mm

3,1 kg

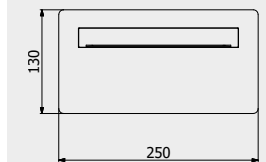

PORTATE | WATER FLOW | DÉBIT D'EAU

| | | |
|--------|--------|--------|
| 1 BAR | 2 BAR | 3 BAR |
| 13 l/m | 17 l/m | 20 l/m |

ARTICLE | ARTICOLO | ARTICLE

WA250



Wall mounted bath filler complete with hand shower kit

Bordo vasca esterno a parete completo di kit doccia

Mitigeur Bain/douche Murale avec douchette encastrée

CODE / COEFFICIENT | CODICE /
COEFFICIENTE | CODE / COEFFICIENT

| | | |
|------|---------|------|
| ● CC | WA250CC | 18,4 |
| ● SS | WA250SS | 23,0 |
| ● BO | WA250BO | 22,1 |
| ● NP | WA250NP | 22,1 |
| ● CF | WA250CF | 27,6 |
| ● CS | WA250CS | 29,4 |
| ● II | WA250II | 27,6 |
| ● IS | WA250IS | 29,4 |
| ● RS | WA250RS | 27,6 |
| ● SR | WA250SR | 29,4 |
| ● OO | WA250OO | 27,6 |
| ● OS | WA250OS | 29,4 |

PACKAGING

 L: 360 mm
D: 220 mm
H: 150 mm

4,2 kg

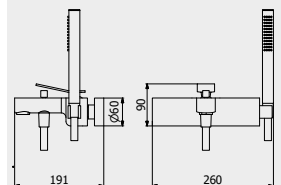

PORTATE | WATER FLOW | DÉBIT D'EAU

| | | |
|----------|----------|--------|
| 1 BAR | 2 BAR | 3 BAR |
| 10,8 l/m | 15,3 l/m | 19 l/m |

ARTICLE | ARTICOLO | ARTICLE

WA740



Two holes deck mounted bath filler mixer with shower kit

Miscelatore bordo vasca da appoggio due fori con doccino

Mitigeur bain/douche deux trous avec douchette

CODE / COEFFICIENT | CODICE /
COEFFICIENTE | CODE / COEFFICIENT

| | | |
|------|---------|------|
| ● CC | WA740CC | 21,6 |
| ● SS | WA740SS | 27,0 |
| ● BO | WA740BO | 25,9 |
| ● NP | WA740NP | 25,9 |
| ● CF | WA740CF | 32,4 |
| ● CS | WA740CS | 34,6 |
| ● II | WA740II | 32,4 |
| ● IS | WA740IS | 34,6 |
| ● RS | WA740RS | 32,4 |
| ● SR | WA740SR | 34,6 |
| ● OO | WA740OO | 32,4 |
| ● OS | WA740OS | 34,6 |

PACKAGING

 L: 370 mm
D: 270 mm
H: 80 mm

5,0 kg

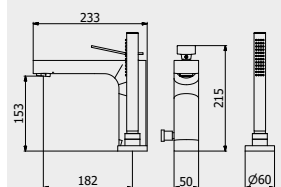

PORTATE | WATER FLOW | DÉBIT D'EAU

| | | |
|----------|----------|----------|
| 1 BAR | 2 BAR | 3 BAR |
| 13,7 l/m | 19,7 l/m | 24,3 l/m |



ARTICLE | ARTICOLO | ARTICLE

WA399



Free-standing bath filler with shower kit
Bordo vasca da terra con kit doccia
Bain douche complet alimentation au sol

| CODE / COEFFICIENT CODICE / COEFFICIENTE | CODE / COEFFICIENT |
|--|--------------------|
| CC | EWA399CC 34,7 |
| SS | EWA399SS 43,4 |
| BO | EWA399BO 41,6 |
| NP | EWA399NP 41,6 |
| CF | EWA399CF 52,1 |
| CS | EWA399CS 55,5 |
| II | EWA399II 52,1 |
| IS | EWA399IS 55,5 |
| RS | EWA399RS 52,1 |
| SR | EWA399SR 55,5 |
| OO | EWA399OO 52,1 |
| OS | EWA399OS 55,5 |

PACKAGING

L: 1110 mm
D: 400 mm
H: 170 mm
11,6 kg

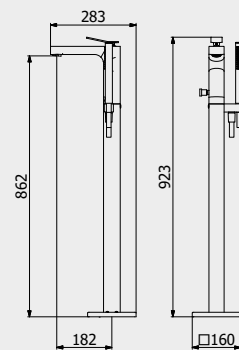

PORTATE | WATER FLOW | DÉBIT D'EAU

| 1 BAR | 2 BAR | 3 BAR |
|----------|----------|----------|
| 13,6 l/m | 19,6 l/m | 24,1 l/m |

Built-in body to be purchased separately
AVAILABLE FROM JANUARY 2020
Corpo incasso da acquistare separatamente
DISPONIBILE DA GENNAIO 2020
Corps intégré à acheter séparément
DISPONIBLE À PARTIR DE JANVIER 2020



CODICE | CODE | CODE

INC399XXXN_19

COEFFICIENTE | COEFFICIENT | COEFFICIENT

2,8

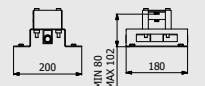

Wave

ARTICLE | ARTICOLO | ARTICLE

WA320



Wall mounted spout
Bocca d'erogazione a parete
Bec de remplissage mural

| CODE / COEFFICIENT CODICE / COEFFICIENTE | CODE / COEFFICIENT |
|--|--------------------|
| CC | WA320CC 4,7 |
| SS | WA320SS 5,9 |
| BO | WA320BO 5,6 |
| NP | WA320NP 5,6 |
| CF | WA320CF 7,1 |
| CS | WA320CS 7,5 |
| II | WA320II 7,1 |
| IS | WA320IS 7,5 |
| RS | WA320RS 7,1 |
| SR | WA320SR 7,5 |
| OO | WA320OO 7,1 |
| OS | WA320OS 7,5 |

PACKAGING

L: 455 mm
D: 107 mm
H: 41 mm
1,0 kg

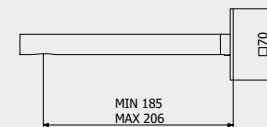

PORTATE | WATER FLOW | DÉBIT D'EAU

| 1 BAR | 2 BAR | 3 BAR |
|--------|--------|--------|
| 16 l/m | 22 l/m | 27 l/m |

ARTICLE | ARTICOLO | ARTICLE

WA706



Exposed parts for bidet spray complete with mixer
Set di parti esterne per Idroscopino igienico con miscelatore
Partie extérieure pour douchette hygiénique avec mitigeur

| CODE / COEFFICIENT CODICE / COEFFICIENTE | CODE / COEFFICIENT |
|--|--------------------|
| CC | EWA706CC 11,0 |
| SS | EWA706SS 13,8 |
| BO | EWA706BO 13,2 |
| NP | EWA706NP 13,2 |
| CF | EWA706CF 16,5 |
| CS | EWA706CS 17,6 |
| II | EWA706II 16,5 |
| IS | EWA706IS 17,6 |
| RS | EWA706RS 16,5 |
| SR | EWA706SR 17,6 |
| OO | EWA706OO 16,5 |
| OS | EWA706OS 17,6 |

PACKAGING

L: 370 mm
D: 270 mm
H: 80 mm
3,1 kg

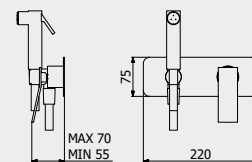

PORTATE | WATER FLOW | DÉBIT D'EAU

| 1 BAR | 2 BAR | 3 BAR |
|---------|---------|-------|
| 2,3 l/m | 3,2 l/m | 4 l/m |

Built-in body to be purchased separately
! Corpo incasso da acquistare separatamente
Corps intégré à acheter séparément



CODICE | CODE | CODE

INC206XXXN_19

COEFFICIENTE | COEFFICIENT | COEFFICIENT

2,9



MODERNA / ACCESSORIES COLLECTION

ARTICLE | ARTICOLO | ARTICLE

M0001



Wall soap-holder

Porta sapone a muro

Porte distributeur de savon encastré

CODE / COEFFICIENT | CODICE /
COEFFICIENTE | CODE / COEFFICIENT

CC M0001CC 1,5

PACKAGING

L: 110 mm
 D: 130 mm
 H: 50 mm
 0,4 kg

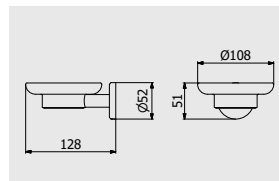

ARTICLE | ARTICOLO | ARTICLE

M0003



Wall toothbrush holder

Bicchiere porta spazzolino a parete

Porte-verre en verre gravé

CODE / COEFFICIENT | CODICE /
COEFFICIENTE | CODE / COEFFICIENT

CC M0003CC 1,5

PACKAGING

L: 70 mm
 D: 110 mm
 H: 100 mm
 0,4 kg

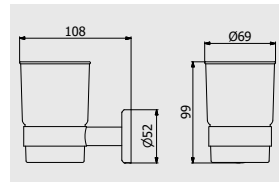

ARTICLE | ARTICOLO | ARTICLE

M0014



Towel holder

Porta salvietta

Porte-serviette

CODE / COEFFICIENT | CODICE /
COEFFICIENTE | CODE / COEFFICIENT

CC M0014CC 2,2

PACKAGING

L: 500 mm
 D: 70 mm
 H: 50 mm
 0,5 kg

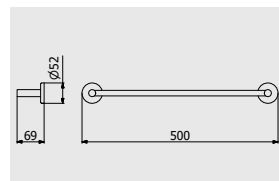

ARTICLE | ARTICOLO | ARTICLE

M0002



Wall soap dispenser holder

Porta dispenser sapone liquido a parete

Porte distributeur de savon en verre gravé

CODE / COEFFICIENT | CODICE /
COEFFICIENTE | CODE / COEFFICIENT

CC M0002CC 2,3

PACKAGING

L: 80 mm
 D: 130 mm
 H: 180 mm
 0,1 kg

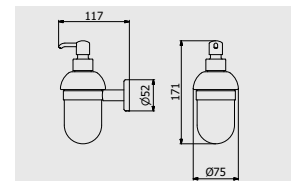

ARTICLE | ARTICOLO | ARTICLE

M0004



Towel holder

Porta salvietta

Porte-serviette

CODE / COEFFICIENT | CODICE /
COEFFICIENTE | CODE / COEFFICIENT

CC M0004CC 2,4

PACKAGING

L: 650 mm
 D: 70 mm
 H: 50 mm
 0,5 kg

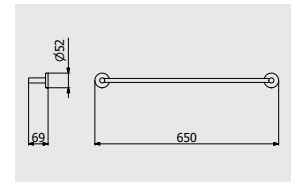

ARTICLE | ARTICOLO | ARTICLE

M0006



Towel holder

Porta salvietta

Porte-serviette

CODE / COEFFICIENT | CODICE /
COEFFICIENTE | CODE / COEFFICIENT

CC M0006CC 2,1

PACKAGING

L: 350 mm
 D: 70 mm
 H: 50 mm
 0,4 kg

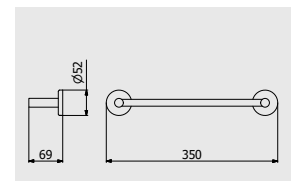

ARTICLE | ARTICOLO | ARTICLE

MO007

Ring Towel holder

Porta salvietta ad anello

Porte-serviettes anneau

CODE / COEFFICIENT | CODICE /
COEFFICIENTE | CODE / COEFFICIENT

CC MO007CC 1,6

PACKAGING

L: 180 mm 0,8 kg
D: 70 mm
H: 200 mm

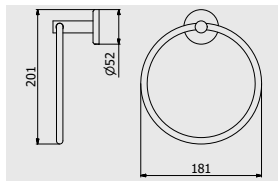

ARTICLE | ARTICOLO | ARTICLE

MO008

Robe Hook

Appendino a parete

Cintre

CODE / COEFFICIENT | CODICE /
COEFFICIENTE | CODE / COEFFICIENT

CC MO008CC 0,9

PACKAGING

L: 50 mm 0,3 kg
D: 50 mm
H: 50 mm

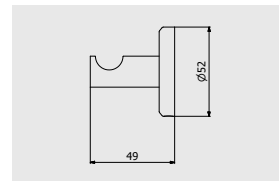

ARTICLE | ARTICOLO | ARTICLE

MO009

Double robe hook

Doppio appendino a parete

Double cintre

CODE / COEFFICIENT | CODICE /
COEFFICIENTE | CODE / COEFFICIENT

CC MO009CC 1,4

PACKAGING

L: 70 mm 0,1 kg
D: 70 mm
H: 50 mm

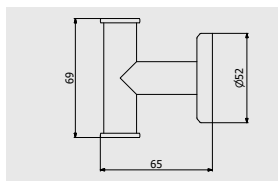

ARTICLE | ARTICOLO | ARTICLE

MO010

Shelf

Mensola

Etagère

CODE / COEFFICIENT | CODICE /
COEFFICIENTE | CODE / COEFFICIENT

CC MO010CC 3,0

PACKAGING

L: 600 mm 0,3 kg
D: 140 mm
H: 50 mm

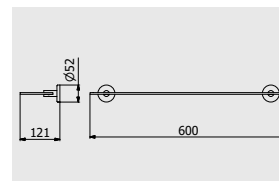

ARTICLE | ARTICOLO | ARTICLE

MO005

Swiveable towel holder

Porta salvietta doppio

Porte-serviettes noeud

CODE / COEFFICIENT | CODICE /
COEFFICIENTE | CODE / COEFFICIENT

CC MO005CC 3,5

PACKAGING

L: 430 mm 0,5 kg
D: 70 mm
H: 50 mm

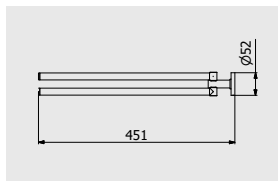

ARTICLE | ARTICOLO | ARTICLE

MO011

Toilet paper holder

Porta rotolo

Porte rouleaux de toilette

CODE / COEFFICIENT | CODICE /
COEFFICIENTE | CODE / COEFFICIENT

CC MO011CC 1,4

PACKAGING

L: 150 mm 0,2 kg
D: 70 mm
H: 50 mm

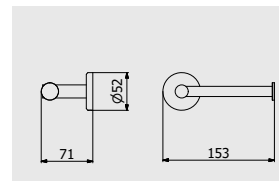

ARTICLE | ARTICOLO | ARTICLE

MO012

Toilet brush holder

Porta scopino da terra

Porte balayette au sol

CODE / COEFFICIENT | CODICE /
COEFFICIENTE | CODE / COEFFICIENT

CC MO012CC 2,5

PACKAGING

L: 80 mm 0,7 kg
D: 80 mm
H: 380 mm

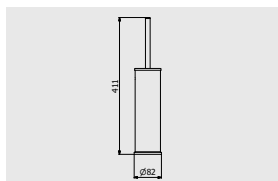

ARTICLE | ARTICOLO | ARTICLE

MO013

Wall toilet brush holder

Porta scopino da parete

Porte balayette

CODE / COEFFICIENT | CODICE /
COEFFICIENTE | CODE / COEFFICIENT

CC MO013CC 2,9

PACKAGING

L: 80 mm 0,7 kg
D: 80 mm
H: 380 mm

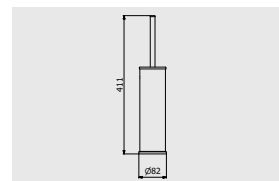

TWITTER

The bathroom collection that speaks to everyone.

TWITTER è la linea bagno che parla a tutti.
TWITTER est la ligne qui s'adresse à tous.

With its simple and delicate shapes, TWITTER is the bathroom collection that speaks to everyone, to the lovers of square lines as to those of the round forms, and it strikes for its essential refinement and delicate aesthetics. With its pleasing linear features, Twitter is the perfect collection for an sober and elegant bathroom.

Dalle forme semplici e delicate, TWITTER è la linea bagno che parla a tutti, agli amanti del tratto squadrato come a quelli della forma arrotondata, e colpisce per la sua essenziale ricercatezza e delicatezza estetica. Con le sue fattezze piacevoli e lineari, Twitter è la serie perfetta per un bagno sobrio ed elegante.

Avec ses formes simples et délicates, TWITTER est la ligne qui s'adresse à tous, aux amants de la ligne carrée comme à ceux de la forme arrondie, et frappe pour son raffinement essentiel et sa délicatesse esthétique. Avec ses formes agréables et linéaires, Twitter est la série parfaite pour une salle de bain sobre et élégante.



ANTI-LIMESCALE



CRYSTAL CLEAR
WATER



LEAD FREE



ZINC FREE



Twitter



DESIGN
LORENZO DAMIANI





← TW200NP
Monohole washbasin mixer
Miscelatore lavabo monoforo
Mitigeur lavabo

↑ TW220NP
Monohole bidet mixer
Miscelatore bidet monoforo
Mitiguer bidet



- ↑ TW200CC
Monohole washbasin mixer
Miscelatore lavabo monoforo
Mitigeur lavabo
- ← TW202CC
Tall monohole washbasin mixer
Miscelatore lavabo monoforo alto
Mitigeur lavabo haut
- TW200NP
Monohole washbasin mixer
Miscelatore lavabo monoforo
Mitigeur lavabo







↑ TW200NP
Monohole washbasin mixer
Miscelatore lavabo monoforo
Mitigeur lavabo

← TW399NP
Free-standing bath filler with shower kit
Bordo vasca da terra con kit doccia
Bain douche complet alimentation au sol



- ↖ **TW300CC**
Wall mounted washbasin mixer
Miscelatore doccia a parete una via
Mitigeur douche mural une voie
- ← **TW350CC**
Wall mounted shower mixer with shower kit
Doccia esterno a parete completo di kit doccia
Mitigeur de douche externe avec flexible et
douchette
- **TW313CC**
Two ways wall shower mixer with shower kit
Miscelatore doccia a parete con deviatore due
vie e doccino integrato
Mitigeur douche mural deux voies avec
inverseur et douchette encastrée



Twitter



← TW250CC
 Wall mounted bath filler with hand shower kit
 Bordo vasca esterno a parete con kit doccia
 Mitigeur Bain/douche Mural avec douchette
 encastrée

↙ TW396CC
 Four holes deck mounted bath filler with
 shower kit
 Bordo vasca quattro fori con deviatore e kit
 doccia
 Bain/douche quatre trous avec inverseur et
 Kit Douche

| | |
|--------------------|---------------|
| A Mixer | C Diverter |
| Miscelatore | Deviatore |
| Mitigeur | Déviateur |
| B Spout | D Hand shower |
| Bocca d'erogazione | Doccino |
| Bec | Douchette |

→ TW399CC
 Free-standing bath filler with shower kit
 Bordo vasca da terra con kit doccia
 Bain douche complet alimentation au sol





Twitter

ARTICLE | ARTICOLO | ARTICLE

TW200



Monohole washbasin mixer complete with drain

Miscelatore lavabo monoforo completo di scarico automatico

Mitigeur lavabo complet avec bonde automatique

| CODE / COEFFICIENT | CODICE / COEFFICIENTE | COEFFICIENT |
|--------------------|-----------------------|-------------|
| ● CC | TW200CC | 6,0 |
| ● SS | TW200SS | 7,5 |
| ● BO | TW200BO | 7,2 |
| ● NP | TW200NP | 7,2 |
| ● CF | TW200CF | 9,0 |
| ● CS | TW200CS | 9,6 |
| ● II | TW200II | 9,0 |
| ● IS | TW200IS | 9,6 |
| ● RS | TW200RS | 9,0 |
| ● SR | TW200SR | 9,6 |
| ● OO | TW200OO | 9,0 |
| ● OS | TW200OS | 9,6 |

PACKAGING

L: 340 mm
D: 180 mm
H: 70 mm

1,7 kg

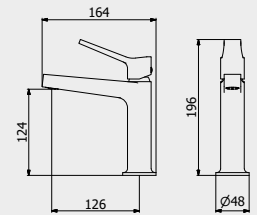

PORTATE | WATER FLOW | DÉBIT D'EAU

| 1 BAR | 2 BAR | 3 BAR |
|---------|---------|---------|
| 5,5 l/m | 7,5 l/m | 9,5 l/m |

ARTICLE | ARTICOLO | ARTICLE

TW202



Tall monohole washbasin mixer complete with drain

Miscelatore lavabo monoforo alto completo di scarico automatico

Mitigeur lavabo haut complet avec bonde automatique

| CODE / COEFFICIENT | CODICE / COEFFICIENTE | COEFFICIENT |
|--------------------|-----------------------|-------------|
| ● CC | TW202CC | 7,1 |
| ● SS | TW202SS | 8,9 |
| ● BO | TW202BO | 8,5 |
| ● NP | TW202NP | 8,5 |
| ● CF | TW202CF | 10,7 |
| ● CS | TW202CS | 11,4 |
| ● II | TW202II | 10,7 |
| ● IS | TW202IS | 11,4 |
| ● RS | TW202RS | 10,7 |
| ● SR | TW202SR | 11,4 |
| ● OO | TW202OO | 10,7 |
| ● OS | TW202OS | 11,4 |

PACKAGING

L: 225 mm
D: 95 mm
H: 70 mm

2,2 kg

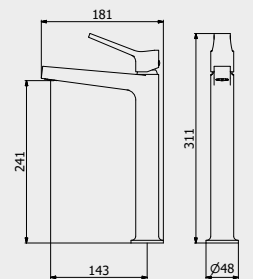

PORTATE | WATER FLOW | DÉBIT D'EAU

| 1 BAR | 2 BAR | 3 BAR |
|---------|---------|---------|
| 5,5 l/m | 7,5 l/m | 9,5 l/m |

ARTICLE | ARTICOLO | ARTICLE

TW206



Wall mounted washbasin mixer complete with drain

Miscelatore lavabo due fori a parete completo di scarico automatico

Mitigeur lavabo mural complet avec bonde automatique

| CODE / COEFFICIENT | CODICE / COEFFICIENTE | COEFFICIENT |
|--------------------|-----------------------|-------------|
| ● CC | ETW206CC | 8,8 |
| ● SS | ETW206SS | 11,0 |
| ● BO | ETW206BO | 10,6 |
| ● NP | ETW206NP | 10,6 |
| ● CF | ETW206CF | 13,2 |
| ● CS | ETW206CS | 14,1 |
| ● II | ETW206II | 13,2 |
| ● IS | ETW206IS | 14,1 |
| ● RS | ETW206RS | 13,2 |
| ● SR | ETW206SR | 14,1 |
| ● OO | ETW206OO | 13,2 |
| ● OS | ETW206OS | 14,1 |

PACKAGING

L: 425 mm
D: 188 mm
H: 98 mm

3,7 kg

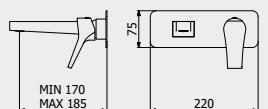

PORTATE | WATER FLOW | DÉBIT D'EAU

| 1 BAR | 2 BAR | 3 BAR |
|---------|---------|----------|
| 6,6 l/m | 9,3 l/m | 11,3 l/m |

Built-in body to be purchased separately

Corpo incasso da acquistare separatamente

Corps intégré à acheter séparément



CODICE | CODE | CODE

INC206XXXN_19

COEFFICIENTE | COEFFICIENT | COEFFICIENT

2,9



ARTICLE | ARTICOLO | ARTICLE

TW210



Ceiling spout with wall mounted mixer
Bocca da soffitto con comando remoto ad incasso
Mitigeur lavabo mural avec bec plafond complet avec bonde automatique

| CODE / COEFFICIENT | CODICE / COEFFICIENTE | CODE / COEFFICIENT |
|--------------------|-----------------------|--------------------|
| CC | ETW210CC | 27,5 |
| SS | ETW210SS | 34,4 |
| BO | ETW210BO | 33,0 |
| NP | ETW210NP | 33,0 |

PACKAGING

- L: 150 mm
D: 190 mm
H: 98 mm
- L: 1700 mm
Ø: 70 mm
- 4,5 kg

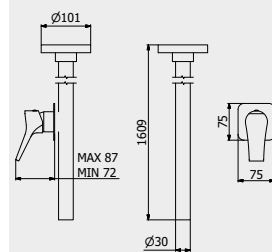

PORTATE | WATER FLOW | DÉBIT D'EAU

| 1 BAR | 2 BAR | 3 BAR |
|---------|---------|-------|
| 4,3 l/m | 5,2 l/m | 7 l/m |

Built-in body to be purchased separately

Corpo incasso da acquistare separatamente
Corps intégré à acheter séparément



CODICE | CODE | CODE

INC300XXXN_19

COEFFICIENTE | COEFFICIENT | COEFFICIENT

1,8



Twitter

ARTICLE | ARTICOLO | ARTICLE

TW220



Monohole bidet mixer complete with drain
Miscelatore bidet monoforo completo di scarico automatico
Mitigeur bidet complet avec bonde automatique

| CODE / COEFFICIENT | CODICE / COEFFICIENTE | CODE / COEFFICIENT |
|--------------------|-----------------------|--------------------|
| CC | TW220CC | 6,0 |
| SS | TW220SS | 7,5 |
| BO | TW220BO | 7,2 |
| NP | TW220NP | 7,2 |
| CF | TW220CF | 9,0 |
| CS | TW220CS | 9,6 |
| II | TW220II | 9,0 |
| IS | TW220IS | 9,6 |
| RS | TW220RS | 9,0 |
| SR | TW220SR | 9,6 |
| OO | TW220OO | 9,0 |
| OS | TW220OS | 9,6 |

PACKAGING

- L: 340 mm
D: 180 mm
H: 70 mm
- 1,6 kg

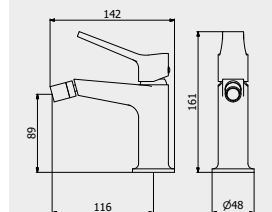

PORTATE | WATER FLOW | DÉBIT D'EAU

| 1 BAR | 2 BAR | 3 BAR |
|---------|---------|---------|
| 5,5 l/m | 7,5 l/m | 9,5 l/m |

ARTICLE | ARTICOLO | ARTICLE

TW300



Exposed parts for manual wall mixer
Set di parti esterne per miscelatore a parete ad una via
Partie extérieure pour mitigeur encastré à une voie

| CODE / COEFFICIENT | CODICE / COEFFICIENTE | CODE / COEFFICIENT |
|--------------------|-----------------------|--------------------|
| CC | ETW300CC | 4,1 |
| SS | ETW300SS | 5,1 |
| BO | ETW300BO | 4,9 |
| NP | ETW300NP | 4,9 |
| CF | ETW300CF | 6,2 |
| CS | ETW300CS | 6,6 |
| II | ETW300II | 6,2 |
| IS | ETW300IS | 6,6 |
| RS | ETW300RS | 6,2 |
| SR | ETW300SR | 6,6 |
| OO | ETW300OO | 6,2 |
| OS | ETW300OS | 6,6 |

PACKAGING

- L: 150 mm
D: 190 mm
H: 98 mm
- 1,7 kg

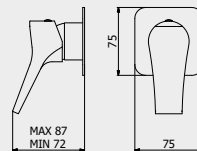

PORTATE | WATER FLOW | DÉBIT D'EAU

| 1 BAR | 2 BAR | 3 BAR |
|----------|----------|--------|
| 11,5 l/m | 16,3 l/m | 20 l/m |

Built-in body to be purchased separately

Corpo incasso da acquistare separatamente
Corps intégré à acheter séparément



CODICE | CODE | CODE

INC300XXXN_19

COEFFICIENTE | COEFFICIENT | COEFFICIENT

1,8



ARTICLE | ARTICOLO | ARTICLE

TW310



Exposed parts for manual wall mixer with two ways diverter
 Miscelatore doccia a parete con deviatore due vie
 Mitigeur douche mural deux voies avec inverseur

| CODE / COEFFICIENT | CODICE / COEFFICIENTE | CODE / COEFFICIENT |
|--------------------|-----------------------|--------------------|
| ● CC | ETW310CC | 6,1 |
| ● SS | ETW310SS | 7,6 |
| ● BO | ETW310BO | 7,3 |
| ● NP | ETW310NP | 7,3 |
| ● CF | ETW310CF | 9,2 |
| ● CS | ETW310CS | 9,8 |
| ● II | ETW310II | 9,2 |
| ● IS | ETW310IS | 9,8 |
| ● RS | ETW310RS | 9,2 |
| ● SR | ETW310SR | 9,8 |
| ● OO | ETW310OO | 9,2 |
| ● OS | ETW310OS | 9,8 |

PACKAGING

L: 150 mm
D: 190 mm
H: 98 mm

1,7 kg

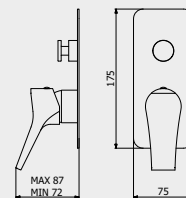

PORTATE | WATER FLOW | DÉBIT D'EAU

| | | |
|---------|----------|--------|
| 1 BAR | 2 BAR | 3 BAR |
| 9,2 l/m | 12,8 l/m | 16 l/m |

Built-in body to be purchased separately

Corpo incasso da acquistare separatamente

Corps intégré à acheter séparément



CODICE | CODE | CODE

INC310XXXN_19

COEFFICIENTE | COEFFICIENT | COEFFICIENT

3,3

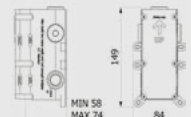

ARTICLE | ARTICOLO | ARTICLE

TW312



Exposed parts for manual wall mixer with three ways diverter
 Set di parti esterne per miscelatore a parete a tre vie
 Mitigeur douche mural trois voies avec inverseur

| CODE / COEFFICIENT | CODICE / COEFFICIENTE | CODE / COEFFICIENT |
|--------------------|-----------------------|--------------------|
| ● CC | ETW312CC | 7,4 |
| ● SS | ETW312SS | 9,3 |
| ● BO | ETW312BO | 8,9 |
| ● NP | ETW312NP | 8,9 |
| ● CF | ETW312CF | 11,1 |
| ● CS | ETW312CS | 11,8 |
| ● II | ETW312II | 11,1 |
| ● IS | ETW312IS | 11,8 |
| ● RS | ETW312RS | 11,1 |
| ● SR | ETW312SR | 11,8 |
| ● OO | ETW312OO | 11,1 |
| ● OS | ETW312OS | 11,8 |

PACKAGING

L: 150 mm
D: 190 mm
H: 98 mm

1,7 kg

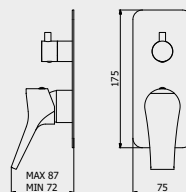

PORTATE | WATER FLOW | DÉBIT D'EAU

| | | |
|---------|----------|----------|
| 1 BAR | 2 BAR | 3 BAR |
| 8,3 l/m | 11,7 l/m | 14,3 l/m |

Built-in body to be purchased separately

Corpo incasso da acquistare separatamente

Corps intégré à acheter séparément



CODICE | CODE | CODE

INC312XXXN_19

COEFFICIENTE | COEFFICIENT | COEFFICIENT

3,3

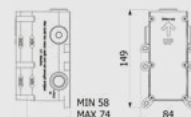

ARTICLE | ARTICOLO | ARTICLE

TW313



Exposed parts for manual wall mixer with 2 ways with shower kit
 Set di parti esterne per miscelatore a parete a due vie completo di kit doccia
 Partie extérieure pour mitigeur encastré à deux voies avec douchette

| CODE / COEFFICIENT | CODICE / COEFFICIENTE | CODE / COEFFICIENT |
|--------------------|-----------------------|--------------------|
| ● CC | ETW313CC | 10,1 |
| ● SS | ETW313SS | 12,6 |
| ● BO | ETW313BO | 12,1 |
| ● NP | ETW313NP | 12,1 |
| ● CF | ETW313CF | 15,2 |
| ● CS | ETW313CS | 16,2 |
| ● II | ETW313II | 15,2 |
| ● IS | ETW313IS | 16,2 |
| ● RS | ETW313RS | 15,2 |
| ● SR | ETW313SR | 16,2 |
| ● OO | ETW313OO | 15,2 |
| ● OS | ETW313OS | 16,2 |

PACKAGING

L: 370 mm
D: 270 mm
H: 80 mm

2,1kg

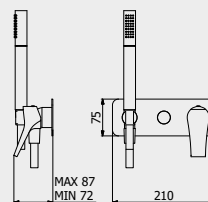

PORTATE | WATER FLOW | DÉBIT D'EAU

| | | |
|--------|----------|----------|
| 1 BAR | 2 BAR | 3 BAR |
| 10 l/m | 14,1 l/m | 17,2 l/m |

Built-in body to be purchased separately

Corpo incasso da acquistare separatamente

Corps intégré à acheter séparément



CODICE | CODE | CODE

INC313XXXN_19

COEFFICIENTE | COEFFICIENT | COEFFICIENT

3,6



ARTICLE | ARTICOLO | ARTICLE

TW314



Exposed parts for manual wall mixer with 3 ways with shower kit
Set di parti esterne per miscelatore a parete a tre vie completo di kit doccia
Partie extérieure pour mitigeur encastré à trois voies avec douchette

| CODE / COEFFICIENT | CODICE / COEFFICIENTE | COEFFICIENT |
|--------------------|-----------------------|-------------|
| CC | ETW314CC | 11,4 |
| SS | ETW314SS | 14,3 |
| BO | ETW314BO | 13,7 |
| NP | ETW314NP | 13,7 |
| CF | ETW314CF | 17,1 |
| CS | ETW314CS | 18,2 |
| II | ETW314II | 17,1 |
| IS | ETW314IS | 18,2 |
| RS | ETW314RS | 17,1 |
| SR | ETW314SR | 18,2 |
| OO | ETW314OO | 17,1 |
| OS | ETW314OS | 18,2 |

PACKAGING

L: 370 mm
D: 270 mm
H: 80 mm
2,1 kg

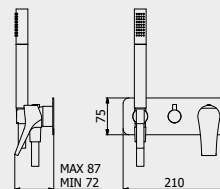

PORTATE | WATER FLOW | DÉBIT D'EAU

| | | |
|---------|----------|----------|
| 1 BAR | 2 BAR | 3 BAR |
| 8,3 l/m | 11,7 l/m | 14,3 l/m |

Built-in body to be purchased separately

Corpo incasso da acquistare separatamente

Corps intégré à acheter séparément



CODICE | CODE | CODE

INC314XXXN_19

COEFFICIENTE | COEFFICIENT | COEFFICIENT

3,7



ARTICLE | ARTICOLO | ARTICLE

TW396



Four holes deck mounted bath filler with shower kit
Bordo vasca quattro fori con deviatore e kit doccia
Bain quatre trous avec inverseur et Kit Douche

| CODE / COEFFICIENT | CODICE / COEFFICIENTE | COEFFICIENT |
|--------------------|-----------------------|-------------|
| CC | TW396CC | 16,2 |
| SS | TW396SS | 20,3 |
| BO | TW396BO | 19,4 |
| NP | TW396NP | 19,4 |
| CF | TW396CF | 24,3 |
| CS | TW396CS | 25,9 |
| II | TW396II | 24,3 |
| IS | TW396IS | 25,9 |
| RS | TW396RS | 24,3 |
| SR | TW396SR | 25,9 |
| OO | TW396OO | 24,3 |
| OS | TW396OS | 25,9 |

PACKAGING

L: 360 mm
D: 220 mm
H: 150 mm
4,4 kg

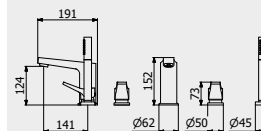

PORTATE | WATER FLOW | DÉBIT D'EAU

| | | |
|----------|----------|----------|
| 1 BAR | 2 BAR | 3 BAR |
| 13,8 l/m | 19,2 l/m | 23,6 l/m |

ARTICLE | ARTICOLO | ARTICLE

TW397



3 holes bath filler with overflow outlet connection, diverter and shower kit
Bordo vasca 3 fori per colonna riempimento con deviatore e kit doccia
Bain 3a trous avec inverseur et kit douche pour remplissage ETP

| CODE / COEFFICIENT | CODICE / COEFFICIENTE | COEFFICIENT |
|--------------------|-----------------------|-------------|
| CC | TW397CC | 12,1 |
| SS | TW397SS | 15,1 |
| BO | TW397BO | 14,5 |
| NP | TW397NP | 14,5 |
| CF | TW397CF | 18,2 |
| CS | TW397CS | 19,4 |
| II | TW397II | 18,2 |
| IS | TW397IS | 19,4 |
| RS | TW397RS | 18,2 |
| SR | TW397SR | 19,4 |
| OO | TW397OO | 18,2 |
| OS | TW397OS | 19,4 |

PACKAGING

L: 360 mm
D: 220 mm
H: 150 mm
3,3 kg

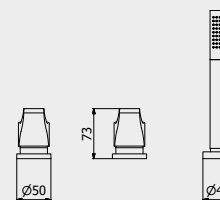

PORTATE | WATER FLOW | DÉBIT D'EAU

| | | |
|----------|----------|----------|
| 1 BAR | 2 BAR | 3 BAR |
| 13,8 l/m | 19,2 l/m | 23,6 l/m |

ARTICLE | ARTICOLO | ARTICLE

TW250



Wall mounted bath filler complete with hand shower kit
Bordo vasca esterno a parete completo di kit doccia
Mitigeur Bain/douche Mural avec douchette encastrée

| CODE / COEFFICIENT | CODICE / COEFFICIENTE | COEFFICIENT |
|--------------------|-----------------------|-------------|
| CC | TW250CC | 7,4 |
| SS | TW250SS | 9,3 |
| BO | TW250BO | 8,9 |
| NP | TW250NP | 8,9 |
| CF | TW250CF | 11,1 |
| CS | TW250CS | 11,8 |
| II | TW250II | 11,1 |
| IS | TW250IS | 11,8 |
| RS | TW250RS | 11,1 |
| SR | TW250SR | 11,8 |
| OO | TW250OO | 11,1 |
| OS | TW250OS | 11,8 |

PACKAGING

L: 370 mm
D: 270 mm
H: 80 mm
2,7 kg

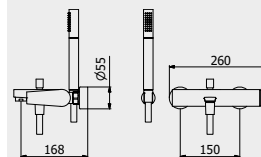

PORTATE | WATER FLOW | DÉBIT D'EAU

| | | |
|--------|----------|----------|
| 1 BAR | 2 BAR | 3 BAR |
| 12 l/m | 16,7 l/m | 20,5 l/m |

ARTICLE | ARTICOLO | ARTICLE

TW350



Wall mounted shower mixer with shower kit

Doccia esterno a parete completo di kit doccia

Mitigeur de douche externe avec flexible et douchette

| CODE / COEFFICIENTE | CODICE / COEFFICIENT | |
|---------------------|----------------------|------|
| CC | TW350CC | 6,6 |
| SS | TW350SS | 8,3 |
| BO | TW350BO | 7,9 |
| NP | TW350NP | 7,9 |
| CF | TW350CF | 9,9 |
| CS | TW350CS | 10,6 |
| II | TW350II | 9,9 |
| IS | TW350IS | 10,6 |
| RS | TW350RS | 9,9 |
| SR | TW350SR | 10,6 |
| OO | TW350OO | 9,9 |
| OS | TW350OS | 10,6 |

PACKAGING

L: 340 mm
D: 180 mm
H: 70 mm

2,2 kg

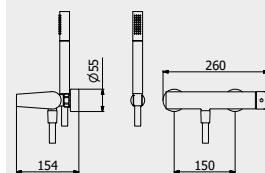

PORTATE | WATER FLOW | DÉBIT D'EAU

| 1 BAR | 2 BAR | 3 BAR |
|-------|--------|--------|
| 6 l/m | 12 l/m | 16 l/m |

ARTICLE | ARTICOLO | ARTICLE

TW399



Free-standing bath filler with shower kit

Bordo vasca da terra con kit doccia

Bain douche complet alimentation au sol

| CODE / COEFFICIENTE | CODICE / COEFFICIENT | |
|---------------------|----------------------|------|
| CC | ETW399CC | 26,9 |
| SS | ETW399SS | 33,6 |
| BO | ETW399BO | 32,3 |
| NP | ETW399NP | 32,3 |
| CF | ETW399CF | 40,4 |
| CS | ETW399CS | 43,0 |
| II | ETW399II | 40,4 |
| IS | ETW399IS | 43,0 |
| RS | ETW399RS | 40,4 |
| SR | ETW399SR | 43,0 |
| OO | ETW399OO | 40,4 |
| OS | ETW399OS | 43,0 |

PACKAGING

L: 1100 mm
D: 395 mm
H: 150 mm

11,6 kg

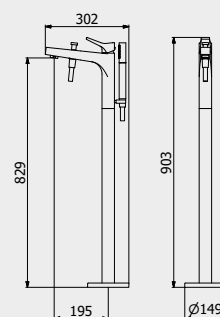

PORTATE | WATER FLOW | DÉBIT D'EAU

| 1 BAR | 2 BAR | 3 BAR |
|----------|----------|--------|
| 13,6 l/m | 19,6 l/m | 24 l/m |

Built-in body to be purchased separately
AVAILABLE FROM JANUARY 2020

Corpo incasso da acquistare separatamente
DISPONIBILE DA GENNAIO 2020

Corps intégré à acheter séparément
DISPONIBLE À PARTIR DE JANVIER 2020



CODICE | CODE | CODE

INC399XXXN_19

COEFFICIENTE | COEFFICIENT | COEFFICIENT

2,8

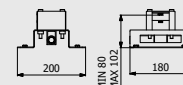

ARTICLE | ARTICOLO | ARTICLE

RU318



Built-in wall mounted waterfall spout

Cascata a parete con erogazione a lama esterna

Cascade murale avec bec externe

| CODE / COEFFICIENTE | CODICE / COEFFICIENT | |
|---------------------|----------------------|------|
| CC | RU318CC | 22,9 |
| SS | RU318SS | 28,6 |
| BO | RU318BO | 27,5 |
| NP | RU318NP | 27,5 |
| CF | RU318CF | 34,4 |
| CS | RU318CS | 36,6 |
| II | RU318II | 34,4 |
| IS | RU318IS | 36,6 |
| RS | RU318RS | 34,4 |
| SR | RU318SR | 36,6 |
| OO | RU318OO | 34,4 |
| OS | RU318OS | 36,6 |

PACKAGING

L: 340 mm
D: 180 mm
H: 70 mm

4,0 kg

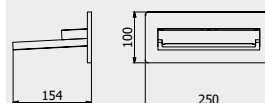

PORTATE | WATER FLOW | DÉBIT D'EAU

| 1 BAR | 2 BAR | 3 BAR |
|--------|--------|--------|
| 13 l/m | 17 l/m | 20 l/m |



ARTICLE | ARTICOLO | ARTICLE

RU319



Wall mounted waterfall
Cascata a parete con erogazione diretta
Cascade murale

| CODE / COEFFICIENT | CODICE / COEFFICIENTE | CODE / COEFFICIENT |
|--------------------|-----------------------|--------------------|
| CC | RU319CC | 12,8 |
| SS | RU319SS | 16,0 |
| BO | RU319BO | 15,4 |
| NP | RU319NP | 15,4 |
| CF | RU319CF | 19,2 |
| CS | RU319CS | 20,5 |
| II | RU319II | 19,2 |
| IS | RU319IS | 20,5 |
| RS | RU319RS | 19,2 |
| SR | RU319SR | 20,5 |
| OO | RU319OO | 19,2 |
| OS | RU319OS | 20,5 |

PACKAGING

L: 340 mm
D: 180 mm
H: 70 mm
3,1 kg

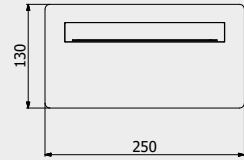

PORTATE | WATER FLOW | DÉBIT D'EAU

| | | |
|--------|--------|--------|
| 1 BAR | 2 BAR | 3 BAR |
| 13 l/m | 17 l/m | 20 l/m |

ARTICLE | ARTICOLO | ARTICLE

TW320



Wall mounted spout
Bocca d'erogazione corta a parete
Bec de remplissage mural court

| CODE / COEFFICIENT | CODICE / COEFFICIENTE | CODE / COEFFICIENT |
|--------------------|-----------------------|--------------------|
| CC | TW320CC | 5,0 |
| SS | TW320SS | 6,3 |
| BO | TW320BO | 6,0 |
| NP | TW320NP | 6,0 |
| CF | TW320CF | 7,5 |
| CS | TW320CS | 8,0 |
| II | TW320II | 7,5 |
| IS | TW320IS | 8,0 |
| RS | TW320RS | 7,5 |
| SR | TW320SR | 8,0 |
| OO | TW320OO | 7,5 |
| OS | TW320OS | 8,0 |

PACKAGING

L: 150 mm
D: 190 mm
H: 98 mm
1,0 kg

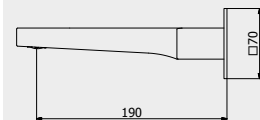

PORTATE | WATER FLOW | DÉBIT D'EAU

| | | |
|---------|----------|--------|
| 1 BAR | 2 BAR | 3 BAR |
| 8,8 l/m | 12,5 l/m | 15 l/m |

ARTICLE | ARTICOLO | ARTICLE

TW706



Exposed parts for bidet spray complete with mixer
Set di parti esterne per Idroscopino igienico con miscelatore
Partie extérieure pour douchette hygiénique avec mitigeur

| CODE / COEFFICIENT | CODICE / COEFFICIENTE | CODE / COEFFICIENT |
|--------------------|-----------------------|--------------------|
| CC | ETW706CC | 9,8 |
| SS | ETW706SS | 12,3 |
| BO | ETW706BO | 11,8 |
| NP | ETW706NP | 11,8 |
| CF | ETW706CF | 14,7 |
| CS | ETW706CS | 15,7 |
| II | ETW706II | 14,7 |
| IS | ETW706IS | 15,7 |
| RS | ETW706RS | 14,7 |
| SR | ETW706SR | 15,7 |
| OO | ETW706OO | 14,7 |
| OS | ETW706OS | 15,7 |

PACKAGING

L: 370 mm
D: 270 mm
H: 80 mm
3,1 kg

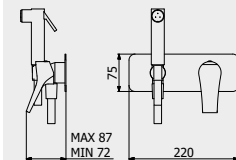

PORTATE | WATER FLOW | DÉBIT D'EAU

| | | |
|---------|---------|-------|
| 1 BAR | 2 BAR | 3 BAR |
| 2,3 l/m | 3,2 l/m | 4 l/m |

Built-in body to be purchased separately
Corpo incasso da acquistare separatamente
Corps intégré à acheter séparément



CODICE | CODE | CODE

INC206XXXN_19

COEFFICIENTE | COEFFICIENT | COEFFICIENT

2,9



MODERNA / ACCESSORIES COLLECTION

ARTICLE | ARTICOLO | ARTICLE

MO001

Wall soap-holder

Porta sapone a muro

Porte distributeur de savon encastré

CODE / COEFFICIENT | CODICE /
COEFFICIENTE | CODE / COEFFICIENT

CC MO001CC 1,5

PACKAGING

L: 110 mm
 D: 130 mm
 H: 50 mm
 0,4 kg

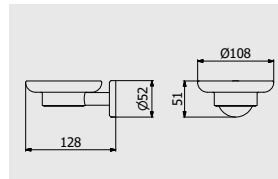

ARTICLE | ARTICOLO | ARTICLE

MO003

Wall toothbrush holder

Bicchiere porta spazzolino a parete

Porte-verre en verre gravé

CODE / COEFFICIENT | CODICE /
COEFFICIENTE | CODE / COEFFICIENT

CC MO003CC 1,5

PACKAGING

L: 70 mm
 D: 110 mm
 H: 100 mm
 0,4 kg

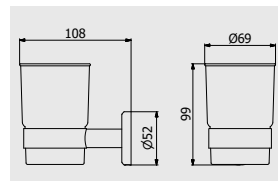

ARTICLE | ARTICOLO | ARTICLE

MO014

Towel holder

Porta salvietta

Porte-serviette

CODE / COEFFICIENT | CODICE /
COEFFICIENTE | CODE / COEFFICIENT

CC MO014CC 2,2

PACKAGING

L: 500 mm
 D: 70 mm
 H: 50 mm
 0,5 kg

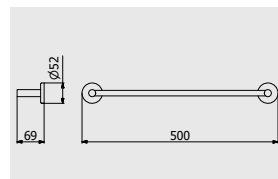

ARTICLE | ARTICOLO | ARTICLE

MO002

Wall soap dispenser holder

Porta dispenser sapone liquido a parete

Porte distributeur de savon en verre gravé

CODE / COEFFICIENT | CODICE /
COEFFICIENTE | CODE / COEFFICIENT

CC MO002CC 2,3

PACKAGING

L: 80 mm
 D: 130 mm
 H: 180 mm
 0,1 kg

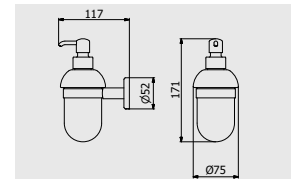

ARTICLE | ARTICOLO | ARTICLE

MO004

Towel holder

Porta salvietta

Porte-serviette

CODE / COEFFICIENT | CODICE /
COEFFICIENTE | CODE / COEFFICIENT

CC MO004CC 2,4

PACKAGING

L: 650 mm
 D: 70 mm
 H: 50 mm
 0,5 kg

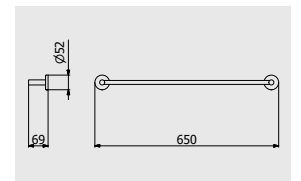

ARTICLE | ARTICOLO | ARTICLE

MO006

Towel holder

Porta salvietta

Porte-serviette

CODE / COEFFICIENT | CODICE /
COEFFICIENTE | CODE / COEFFICIENT

CC MO006CC 2,1

PACKAGING

L: 350 mm
 D: 70 mm
 H: 50 mm
 0,4 kg

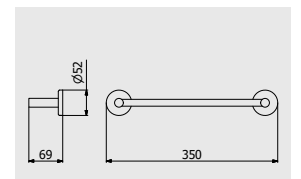

ARTICLE | ARTICOLO | ARTICLE

MO007

Ring Towel holder

Porta salvietta ad anello

Porte-serviette anneau

CODE / COEFFICIENT | CODICE /
COEFFICIENTE | CODE / COEFFICIENT

CC MO007CC 1,6

PACKAGING

L: 180 mm 0,8 kg
D: 70 mm
H: 200 mm

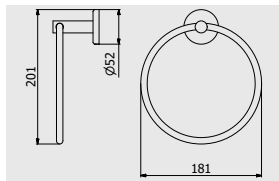

ARTICLE | ARTICOLO | ARTICLE

MO008

Robe Hook

Appendino a parete

Cintre

CODE / COEFFICIENT | CODICE /
COEFFICIENTE | CODE / COEFFICIENT

CC MO008CC 0,9

PACKAGING

L: 50 mm 0,3 kg
D: 50 mm
H: 50 mm

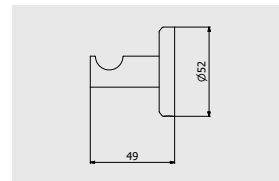

ARTICLE | ARTICOLO | ARTICLE

MO009

Double robe hook

Doppio appendino a parete

Double cintre

CODE / COEFFICIENT | CODICE /
COEFFICIENTE | CODE / COEFFICIENT

CC MO009CC 1,4

PACKAGING

L: 70 mm 0,1 kg
D: 70 mm
H: 50 mm

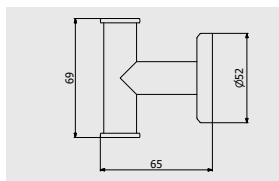

ARTICLE | ARTICOLO | ARTICLE

MO010

Shelf

Mensola

Etagère

CODE / COEFFICIENT | CODICE /
COEFFICIENTE | CODE / COEFFICIENT

CC MO010CC 3,0

PACKAGING

L: 600 mm 0,3 kg
D: 140 mm
H: 50 mm

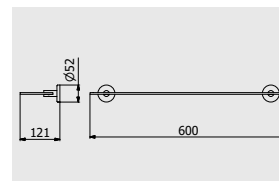

ARTICLE | ARTICOLO | ARTICLE

MO005

Swiveable towel holder

Porta salvietta doppio

Porte-serviette noeud

CODE / COEFFICIENT | CODICE /
COEFFICIENTE | CODE / COEFFICIENT

CC MO005CC 3,5

PACKAGING

L: 430 mm 0,5 kg
D: 70 mm
H: 50 mm

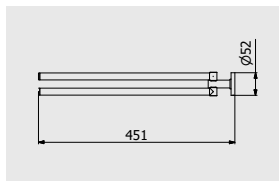

ARTICLE | ARTICOLO | ARTICLE

MO011

Toilet paper holder

Porta rotolo

Porte rouleaux de toilette

CODE / COEFFICIENT | CODICE /
COEFFICIENTE | CODE / COEFFICIENT

CC MO011CC 1,4

PACKAGING

L: 150 mm 0,2 kg
D: 70 mm
H: 50 mm

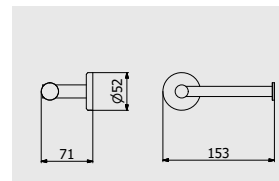

ARTICLE | ARTICOLO | ARTICLE

MO012

Toilet brush holder

Porta scopino da terra

Porte balayette au sol

CODE / COEFFICIENT | CODICE /
COEFFICIENTE | CODE / COEFFICIENT

CC MO012CC 2,5

PACKAGING

L: 80 mm 0,7 kg
D: 80 mm
H: 380 mm

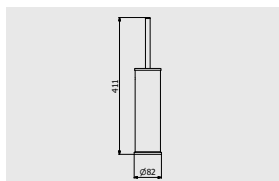

ARTICLE | ARTICOLO | ARTICLE

MO013

Wall toilet brush holder

Porta scopino da parete

Porte balayette

CODE / COEFFICIENT | CODICE /
COEFFICIENTE | CODE / COEFFICIENT

CC MO013CC 2,9

PACKAGING

L: 80 mm 0,7 kg
D: 80 mm
H: 380 mm

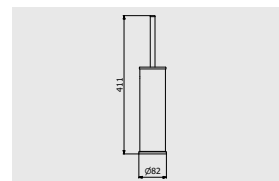

Twitter

SUPERBOX

It make even the simplest and everyday gesture funny and thrilling.

Rende divertente e stimolante anche il gesto più semplice e quotidiano.
Il rend amusants et stimulants même les gestes les plus simples et quotidiens.

There are simple faucets, and then there's Supebox. This collection is able to make even the simplest and everyday gesture funny and thrilling. An innovative and exciting joystick lever steers the water pouring, just like a video game. The absence of an aerator allows the water to flow neatly and sharply from the spout, as fast as a superhero's blade.

Esistono dei semplici rubinetti, e poi c'è Supebox. Questa linea rende divertente e stimolante anche il gesto più semplice e quotidiano. La fuoriuscita dell'acqua è pilotata da una leva a joystick innovativa e appassionante, proprio come un videogioco. L'assenza di aeratore permette all'acqua di fluire dalla bocca in maniera decisa e tagliente, veloce come la lama di un supereroe.

Il y a des robinets simples, et puis il y a Supebox. Cette collection rend amusants et stimulants même les gestes les plus simples et quotidiens. L'écoulement d'eau est piloté par un levier joystick innovateur et passionnant, à la manière d'un jeu vidéo. L'absence d'aérateur permet à l'eau de s'écouler de la bouche de façon résolue et nette, aussi rapide que l'épée d'un super-héros.



KITCHEN
AVAILABLE



CRYSTAL CLEAR
WATER



LEAD FREE



ZINC FREE



Superbox



DESIGN
CRESCENT DESIGN



- ↑ SB306CC
Wall mounted widespread lavatory faucet
Rubinetto lavabo da incasso
Robinet de lavabo mural
- ↙ SB200CC
Monohole washbasin mixer
Miscelatore lavabo monoforo
Mitigeur lavabo complet
- SB202CC
Tall monohole washbasin mixer
Miscelatore lavabo monoforo alto
Mitigeur lavabo haut







Superbox

← SB390CC
Three holes washbasin set with tall spout
Lavabo tre fori bocca alta completo
Lavabo trois trous bec haut

↗ SB220CC
Monohole bidet mixer
Miscelatore bidet monoforo
Mitigeur bidet complet

→ SB300CC
One way wall shower mixer
Miscelatore doccia a parete una via
Mitigeur douche mural une voie







Superbox

← SB250CC
 Wall mounted bath filler with hand shower kit
 Bordo vasca esterno a parete con kit doccia
 Mitigeur Bain/douche Mural avec douchette
 encastrée

↑ SB396CC
 Five holes deck mounted bath filler with
 shower kit
 Bordo vasca cinque fori con deviatore e kit
 doccia
 Bain/douche cinq trous avec inverseur et Kit
 Douche

| | |
|---------------------|----------------------|
| A Hot water | D Diverter |
| Acqua calda | Deviatore |
| Eau chaude | Déviateur |
| B Spout | E Hand shower |
| Bocca d'erogazione | Doccino |
| Bec | Douchette |
| C Cold water | |
| Acqua fredda | |
| Eau froide | |

→ SB350CC
 Wall mounted shower mixer with shower kit
 Doccia esterno a parete con kit doccia
 Mitigeur de douche externe avec flexible et
 douchette



ARTICLE | ARTICOLO | ARTICLE

SB200



Monohole washbasin mixer complete with drain

Miscelatore lavabo monoforo completo di scarico automatico

Mitigeur lavabo complet avec bonde automatique

CODICE / COEFFICIENTE | CODE /
COEFFICIENT | CODE / COEFFICIENT

| | | |
|------|---------|------|
| ● CC | SB200CC | 12,2 |
| ● SS | SB200SS | 15,3 |
| ● NP | SB200NP | 14,6 |
| ● OS | SB200OS | 19,5 |
| ● RS | SB200RS | 18,3 |
| ● ON | SB200ON | 12,2 |

PACKAGING

 L: 225 mm
D: 95 mm
H: 70 mm

2,6 kg

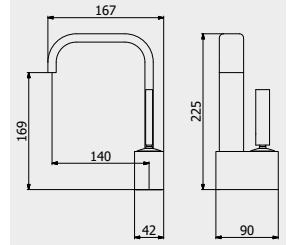

PORTATE | WATER FLOW | DÉBIT D'EAU

| | | |
|-------|--------|--------|
| 1 BAR | 2 BAR | 3 BAR |
| 8 l/m | 11 l/m | 13 l/m |

ARTICLE | ARTICOLO | ARTICLE

SB202



Tall monohole washbasin mixer complete with drain

Miscelatore lavabo monoforo alto completo di scarico automatico

Mitigeur lavabo haut complet avec bonde automatique

CODICE / COEFFICIENTE | CODE /
COEFFICIENT | CODE / COEFFICIENT

| | | |
|------|---------|------|
| ● CC | SB202CC | 12,6 |
| ● SS | SB202SS | 15,8 |
| ● NP | SB202NP | 15,1 |
| ● OS | SB202OS | 20,2 |
| ● RS | SB202RS | 18,9 |
| ● ON | SB202ON | 12,6 |

PACKAGING

 L: 225 mm
D: 95 mm
H: 70 mm

2,8 kg

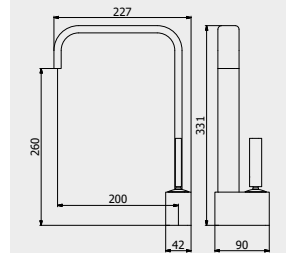

PORTATE | WATER FLOW | DÉBIT D'EAU

| | | |
|-------|--------|--------|
| 1 BAR | 2 BAR | 3 BAR |
| 8 l/m | 11 l/m | 13 l/m |

ARTICLE | ARTICOLO | ARTICLE

SB306



Wall mounted widespread lavatory faucet

Rubinetto lavabo da incasso

Robinet de lavabo mural

CODICE / COEFFICIENTE | CODE /
COEFFICIENT | CODE / COEFFICIENT

| | | |
|------|---------|------|
| ● CC | SB306CC | 15,1 |
| ● SS | SB306SS | 18,9 |
| ● NP | SB306NP | 18,1 |
| ● OS | SB306OS | 24,2 |
| ● RS | SB306RS | 22,7 |
| ● ON | SB306ON | 15,1 |

PACKAGING

 L: 265 mm
D: 260 mm
H: 70 mm

1,9 kg

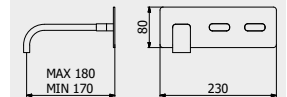

PORTATE | WATER FLOW | DÉBIT D'EAU

| | | |
|--------|----------|--------|
| 1 BAR | 2 BAR | 3 BAR |
| 10 l/m | 10,5 l/m | 11 l/m |

ARTICLE | ARTICOLO | ARTICLE

SB307



Wall mounted widespread lavatory faucet with long spout

Rubinetto lavabo da incasso a bocca lunga

Robinet de lavabo mural avec bec long

CODICE / COEFFICIENTE | CODE /
COEFFICIENT | CODE / COEFFICIENT

| | | |
|------|---------|------|
| ● CC | SB307CC | 15,4 |
| ● SS | SB307SS | 19,3 |
| ● NP | SB307NP | 18,5 |
| ● OS | SB307OS | 24,6 |
| ● RS | SB307RS | 23,1 |
| ● ON | SB307ON | 15,4 |

PACKAGING

 L: 265 mm
D: 260 mm
H: 70 mm

1,9 kg

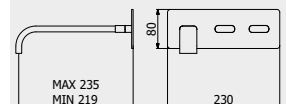

PORTATE | WATER FLOW | DÉBIT D'EAU

| | | |
|----------|----------|----------|
| 1 BAR | 2 BAR | 3 BAR |
| 10,3 l/m | 10,5 l/m | 10,7 l/m |



ARTICLE | ARTICOLO | ARTICLE

SB308



Wall mounted washbasin mixer with short spout complete with drain
 Miscelatore lavabo a parete con bocca corta completo di scarico
 Mitigeur lavabo mural bec court complet avec bonde automatique

| CODICE / COEFFICIENTE | CODE / COEFFICIENT | |
|-----------------------|--------------------|------|
| CC | SB308CC | 15,4 |
| SS | SB308SS | 19,3 |
| NP | SB308NP | 18,5 |
| OS | SB308OS | 24,6 |
| RS | SB308RS | 23,1 |
| ON | SB308ON | 15,4 |

PACKAGING

L: 265 mm
 D: 260 mm
 H: 70 mm
 1,9 kg

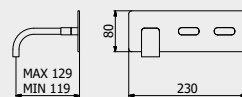

PORTATE | WATER FLOW | DÉBIT D'EAU

| 1 BAR | 2 BAR | 3 BAR |
|----------|----------|----------|
| 10,3 l/m | 10,5 l/m | 10,7 l/m |

ARTICLE | ARTICOLO | ARTICLE

SB210



Ceiling spout with wall mounted mixer
 Bocca da soffitto con comando remoto ad incasso
 Mitigeur lavabo mural avec bec plafond complet avec bonde automatique

| CODICE / COEFFICIENTE | CODE / COEFFICIENT | |
|-----------------------|--------------------|------|
| CC | ESB210CC | 27,5 |
| SS | ESB210SS | 34,4 |
| NP | ESB210NP | 33,0 |
| RS | ESB210RS | 41,3 |

PACKAGING

L: 150 mm
 D: 190 mm
 H: 98 mm
 L: 1700 mm
 Ø: 70 mm
 4,5 kg

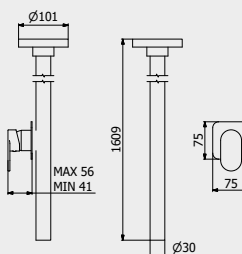

PORTATE | WATER FLOW | DÉBIT D'EAU

| 1 BAR | 2 BAR | 3 BAR |
|---------|---------|-------|
| 4,3 l/m | 5,2 l/m | 7 l/m |

Superbox

Built-in body to be purchased separately

Corpo incasso da acquistare separatamente
 Corps intégré à acheter séparément



CODICE | CODE | CODE

INC300XXXN_19

COEFFICIENTE | COEFFICIENT | COEFFICIENT

1,8

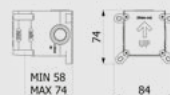

ARTICLE | ARTICOLO | ARTICLE

SB390



Three holes washbasin set with tall spout
 Lavabo tre fori bocca alta completo di scarico automatico
 Lavabo trois trous bec haut

| CODICE / COEFFICIENTE | CODE / COEFFICIENT | |
|-----------------------|--------------------|------|
| CC | SB390CC | 13,8 |
| SS | SB390SS | 17,3 |
| NP | SB390NP | 16,6 |
| OS | SB390OS | 22,1 |
| RS | SB390RS | 20,7 |
| ON | SB390ON | 13,8 |

PACKAGING

L: 455 mm
 D: 310 mm
 H: 75 mm
 3,2 kg

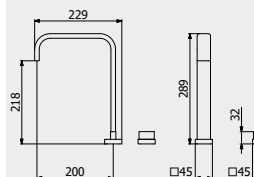

PORTATE | WATER FLOW | DÉBIT D'EAU

| 1 BAR | 2 BAR | 3 BAR |
|--------|----------|----------|
| 10 l/m | 10,5 l/m | 11,5 l/m |

ARTICLE | ARTICOLO | ARTICLE

SB392



Three holes washbasin set with low spout

Lavabo tre fori a bocca bassa completo di scarico automatico

Lavabo trois trous bec bas

CODICE / COEFFICIENTE | CODE /
COEFFICIENT | CODE / COEFFICIENT

| | | | |
|---|----|---------|------|
| ● | CC | SB392CC | 12,6 |
| ● | SS | SB392SS | 15,8 |
| ● | NP | SB392NP | 15,1 |
| ● | OS | SB392OS | 20,2 |
| ● | RS | SB392RS | 18,9 |
| ● | ON | SB392ON | 12,6 |

PACKAGING

L: 455 mm
D: 310 mm
H: 75 mm

3 kg

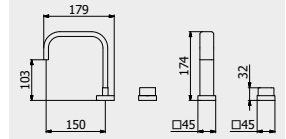

PORTATE | WATER FLOW | DÉBIT D'EAU

| | | |
|--------|----------|----------|
| 1 BAR | 2 BAR | 3 BAR |
| 10 l/m | 10,5 l/m | 11,5 l/m |

ARTICLE | ARTICOLO | ARTICLE

SB220



Monohole bidet mixer complete with drain

Miscelatore bidet monoforo completo di scarico automatico

Mitigeur bidet complet avec bonde automatique

CODICE / COEFFICIENTE | CODE /
COEFFICIENT | CODE / COEFFICIENT

| | | | |
|---|----|---------|------|
| ● | CC | SB220CC | 12,2 |
| ● | SS | SB220SS | 15,3 |
| ● | NP | SB220NP | 14,6 |
| ● | OS | SB220OS | 19,5 |
| ● | RS | SB220RS | 18,3 |
| ● | ON | SB220ON | 12,2 |

PACKAGING

L: 225 mm
D: 95 mm
H: 70 mm

2,6 kg

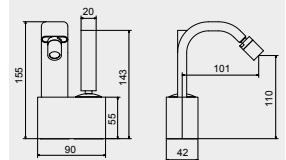

PORTATE | WATER FLOW | DÉBIT D'EAU

| | | |
|-------|--------|--------|
| 1 BAR | 2 BAR | 3 BAR |
| 8 l/m | 11 l/m | 13 l/m |

ARTICLE | ARTICOLO | ARTICLE

SB300



Exposed parts for manual wall mixer

Set di parti esterne per miscelatore a parete ad una via

Partie extérieure pour mitigeur encastré à une voie

CODICE / COEFFICIENTE | CODE /
COEFFICIENT | CODE / COEFFICIENT

| | | | |
|---|----|----------|-----|
| ● | CC | ESB300CC | 4,1 |
| ● | SS | ESB300SS | 5,1 |
| ● | NP | ESB300NP | 4,9 |
| ● | OS | ESB300OS | 6,6 |
| ● | RS | ESB300RS | 6,2 |
| ● | ON | ESB300ON | 4,1 |

PACKAGING

L: 150 mm
D: 190 mm
H: 98 mm

1,9 kg

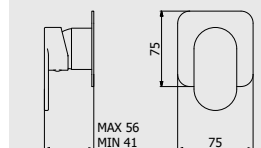

PORTATE | WATER FLOW | DÉBIT D'EAU

| | | |
|----------|----------|--------|
| 1 BAR | 2 BAR | 3 BAR |
| 11,5 l/m | 10,3 l/m | 20 l/m |

Built-in body to be purchased separately

Corpo incasso da acquistare separatamente

Corps intégré à acheter séparément



CODICE | CODE | CODE

INC300XXXN_19

COEFFICIENTE | COEFFICIENT | COEFFICIENT

1,8

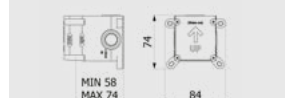

ARTICLE | ARTICOLO | ARTICLE

SB310



Exposed parts for manual wall mixer with two ways diverter
 Miscelatore doccia a parete con deviatore due vie
 Mitigeur douche mural deux voies avec inverseur

| CODICE / COEFFICIENTE CODE / COEFFICIENT | | |
|--|----------|-----|
| CC | ESB310CC | 6,1 |
| SS | ESB310SS | 7,6 |
| NP | ESB310NP | 7,3 |
| OS | ESB310OS | 9,8 |
| RS | ESB310RS | 9,2 |
| ON | ESB310ON | 6,1 |

PACKAGING
 L: 150 mm
 D: 190 mm
 H: 98 mm
 1,9 kg

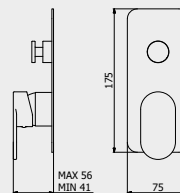

PORTATE | WATER FLOW | DÉBIT D'EAU

| 1 BAR | 2 BAR | 3 BAR |
|---------|----------|--------|
| 9,2 l/m | 12,8 l/m | 16 l/m |

Built-in body to be purchased separately

Corpo incasso da acquistare separatamente
 Corps intégré à acheter séparément



CODICE | CODE | CODE

INC310XXXN_19

COEFFICIENTE | COEFFICIENT | COEFFICIENT

3,3

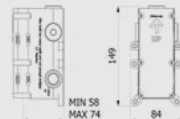

ARTICLE | ARTICOLO | ARTICLE

SB312



Exposed parts for manual wall mixer with three ways diverter
 Set di parti esterne per miscelatore a parete a tre vie
 Mitigeur douche mural trois voies avec inverseur

| CODICE / COEFFICIENTE CODE / COEFFICIENT | | |
|--|----------|------|
| CC | ESB312CC | 7,4 |
| SS | ESB312SS | 9,3 |
| NP | ESB312NP | 8,9 |
| OS | ESB312OS | 11,8 |
| RS | ESB312RS | 11,1 |
| ON | ESB312ON | 7,4 |

PACKAGING
 L: 150 mm
 D: 190 mm
 H: 98 mm
 1,9 kg

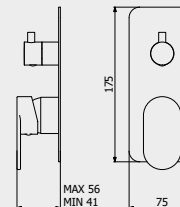

PORTATE | WATER FLOW | DÉBIT D'EAU

| 1 BAR | 2 BAR | 3 BAR |
|---------|----------|----------|
| 8,3 l/m | 11,7 l/m | 14,3 l/m |

Built-in body to be purchased separately

Corpo incasso da acquistare separatamente
 Corps intégré à acheter séparément



CODICE | CODE | CODE

INC312XXXN_19

COEFFICIENTE | COEFFICIENT | COEFFICIENT

3,3

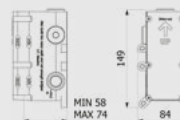

ARTICLE | ARTICOLO | ARTICLE

SB313



Exposed parts for manual wall mixer with 2 ways with shower kit
 Set di parti esterne per miscelatore a parete a due vie completo di kit doccia
 Partie extérieure pour mitigeur encastré à deux voies avec douchette

| CODICE / COEFFICIENTE CODE / COEFFICIENT | | |
|--|----------|------|
| CC | ESB313CC | 10,1 |
| SS | ESB313SS | 12,6 |
| NP | ESB313NP | 12,1 |
| OS | ESB313OS | 16,2 |
| RS | ESB313RS | 15,2 |
| ON | ESB313ON | 10,1 |

PACKAGING
 L: 370 mm
 D: 270 mm
 H: 80 mm
 2,1 kg

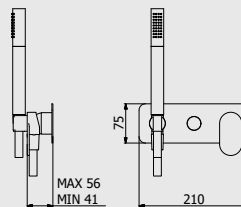

PORTATE | WATER FLOW | DÉBIT D'EAU

| 1 BAR | 2 BAR | 3 BAR |
|--------|----------|----------|
| 10 l/m | 14,1 l/m | 17,2 l/m |

Built-in body to be purchased separately

Corpo incasso da acquistare separatamente
 Corps intégré à acheter séparément



CODICE | CODE | CODE

INC313XXXN_19

COEFFICIENTE | COEFFICIENT | COEFFICIENT

3,6



Superbox

ARTICLE | ARTICOLO | ARTICLE

SB314



Exposed parts for manual wall mixer with 3 ways with shower kit
Set di parti esterne per miscelatore a parete a tre vie completo di kit doccia
Partie extérieure pour mitigeur encastré à trois voies avec douchette

CODICE / COEFFICIENTE | CODE / COEFFICIENT

| | | |
|----|----------|------|
| CC | ESB314CC | 11,4 |
| SS | ESB314SS | 14,3 |
| NP | ESB314NP | 13,7 |
| OS | ESB314OS | 18,2 |
| RS | ESB314RS | 17,1 |
| ON | ESB314ON | 11,4 |

PACKAGING

L: 370 mm
D: 270 mm
H: 80 mm

2,1 kg

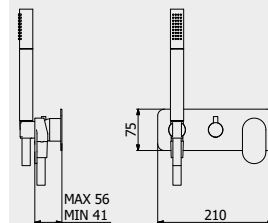

PORTATE | WATER FLOW | DÉBIT D'EAU

| | | |
|---------|----------|----------|
| 1 BAR | 2 BAR | 3 BAR |
| 8,3 l/m | 11,7 l/m | 14,3 l/m |

Built-in body to be purchased separately

Corpo incasso da acquistare separatamente

Corps intégré à acheter séparément



CODICE | CODE | CODE

INC314XXXN_19

COEFFICIENTE | COEFFICIENT | COEFFICIENT

3,7



ARTICLE | ARTICOLO | ARTICLE

SB250



Wall mounted bath filler complete with hand shower kit
Bordo vasca esterno a parete completo di kit doccia
Mitigeur bain/douche mural avec douchette encastrée

CODICE / COEFFICIENTE | CODE / COEFFICIENT

| | | |
|----|---------|------|
| CC | SB250CC | 16,9 |
| SS | SB250SS | 21,1 |
| NP | SB250NP | 20,3 |
| OS | SB250OS | 27,0 |
| RS | SB250RS | 25,4 |
| ON | SB250ON | 16,9 |

PACKAGING

L: 370 mm
D: 270 mm
H: 80 mm

4,4 kg

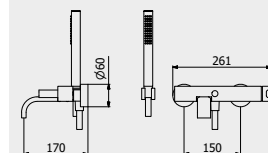

PORTATE | WATER FLOW | DÉBIT D'EAU

| | | |
|--------|--------|--------|
| 1 BAR | 2 BAR | 3 BAR |
| 10 l/m | 14 l/m | 17 l/m |

ARTICLE | ARTICOLO | ARTICLE

SB396



Five holes deck mounted bath filler with shower kit
Bordo vasca cinque fori con deviatore e kit doccia
Bain/douche cinq trous avec inverseur et kit douche

CODICE / COEFFICIENTE | CODE / COEFFICIENT

| | | |
|----|---------|------|
| CC | SB396CC | 21,4 |
| SS | SB396SS | 26,8 |
| NP | SB396NP | 25,7 |
| OS | SB396OS | 34,2 |
| RS | SB396RS | 32,1 |
| ON | SB396ON | 21,4 |

PACKAGING

L: 400 mm
D: 250 mm
H: 140 mm

5,0 kg

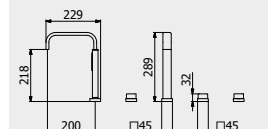

PORTATE | WATER FLOW | DÉBIT D'EAU

| | | |
|--------|--------|--------|
| 1 BAR | 2 BAR | 3 BAR |
| 21 l/m | 29 l/m | 36 l/m |

ARTICLE | ARTICOLO | ARTICLE

SB397



4 holes bath filler with overflow outlet connection, and shower kit
Bordo vasca 4 fori per colonna riempimento con deviatore e kit doccia
Bain quatre trous avec inverseur et kit douche pour remplissage ETP

CODICE / COEFFICIENTE | CODE / COEFFICIENT

| | | |
|----|---------|------|
| CC | SB397CC | 14,7 |
| SS | SB397SS | 18,4 |
| NP | SB397NP | 17,6 |
| OS | SB397OS | 23,5 |
| RS | SB397RS | 22,1 |
| ON | SB397ON | 14,7 |

PACKAGING

L: 370 mm
D: 270 mm
H: 80 mm

4 kg

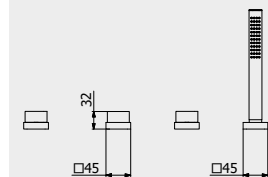

PORTATE | WATER FLOW | DÉBIT D'EAU

| | | |
|--------|--------|--------|
| 1 BAR | 2 BAR | 3 BAR |
| 21 l/m | 29 l/m | 36 l/m |



ARTICLE | ARTICOLO | ARTICLE

SB350



Wall mounted shower mixer with shower kit

Doccia esterno a parete completo di kit doccia

Mitigeur de douche externe avec flexible et douchette

CODICE / COEFFICIENTE | CODE / COEFFICIENT

| | | |
|----|---------|------|
| CC | SB350CC | 12,1 |
| SS | SB350SS | 15,1 |
| NP | SB350NP | 14,5 |
| OS | SB350OS | 19,4 |
| RS | SB350RS | 18,2 |
| ON | SB350ON | 12,1 |

PACKAGING

| |
|-----------|
| L: 370 mm |
| D: 270 mm |
| H: 80 mm |
| 4,1 kg |

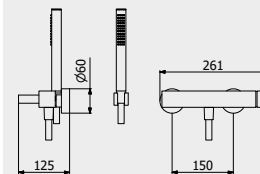

PORTATE | WATER FLOW | DÉBIT D'EAU

| | | |
|----------|--------|--------|
| 1 BAR | 2 BAR | 3 BAR |
| 12,5 l/m | 18 l/m | 21 l/m |

ARTICLE | ARTICOLO | ARTICLE

RU318



Built-in wall mounted waterfall spout

Cascata a parete con erogazione a lama esterna

Cascade murale avc bec externe

CODE / COEFFICIENT | CODICE / COEFFICIENT

| | | |
|----|---------|------|
| CC | RU318CC | 22,9 |
| SS | RU318SS | 28,6 |
| BO | RU318BO | 27,5 |
| NP | RU318NP | 27,5 |
| CF | RU318CF | 34,4 |
| CS | RU318CS | 36,6 |
| II | RU318II | 34,4 |
| IS | RU318IS | 36,6 |
| RS | RU318RS | 34,4 |
| SR | RU318SR | 36,6 |
| OO | RU318OO | 34,4 |
| OS | RU318OS | 36,6 |

PACKAGING

| |
|-----------|
| L: 340 mm |
| D: 180 mm |
| H: 70 mm |
| 4,0 kg |

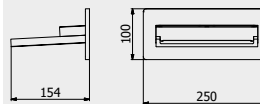

PORTATE | WATER FLOW | DÉBIT D'EAU

| | | |
|--------|--------|--------|
| 1 BAR | 2 BAR | 3 BAR |
| 13 l/m | 17 l/m | 20 l/m |

Superbox

ARTICLE | ARTICOLO | ARTICLE

RU319



Wall mounted waterfall

Cascata a parete con erogazione diretta

Cascade murale

CODICE / COEFFICIENT | CODICE / COEFFICIENT

| | | |
|----|---------|------|
| CC | RU319CC | 12,8 |
| SS | RU319SS | 16,0 |
| BO | RU319BO | 15,4 |
| NP | RU319NP | 15,4 |
| CF | RU319CF | 19,2 |
| CS | RU319CS | 20,5 |
| II | RU319II | 19,2 |
| IS | RU319IS | 20,5 |
| RS | RU319RS | 19,2 |
| SR | RU319SR | 20,5 |
| OO | RU319OO | 19,2 |
| OS | RU319OS | 20,5 |

PACKAGING

| |
|-----------|
| L: 340 mm |
| D: 180 mm |
| H: 70 mm |
| 3,1 kg |

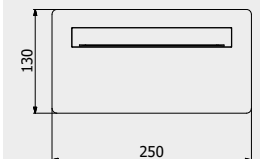

PORTATE | WATER FLOW | DÉBIT D'EAU

| | | |
|--------|--------|--------|
| 1 BAR | 2 BAR | 3 BAR |
| 13 l/m | 17 l/m | 20 l/m |

ARTICLE | ARTICOLO | ARTICLE

SB320



Wall mounted spout

Bocca d'erogazione corta a parete

Bec de remplissage mural court

CODICE / COEFFICIENTE | CODE / COEFFICIENT

| | | |
|----|---------|-----|
| CC | SB320CC | 4,7 |
| SS | SB320SS | 5,9 |
| NP | SB320NP | 5,6 |
| OS | SB320OS | 7,5 |
| RS | SB320RS | 7,1 |
| ON | SB320ON | 4,7 |

PACKAGING

| |
|-----------|
| L: 210 mm |
| D: 130 mm |
| H: 70 mm |
| 0,5 kg |

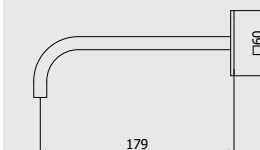

PORTATE | WATER FLOW | DÉBIT D'EAU

| | | |
|--------|--------|----------|
| 1 BAR | 2 BAR | 3 BAR |
| 10 l/m | 11 l/m | 12,5 l/m |

ARTICLE | ARTICOLO | ARTICLE

SB321



Short wall mounted spout

Bocca d'erogazione corta a parete

Bec de remplissage mural court

CODICE / COEFFICIENTE | CODE /
COEFFICIENT | CODE / COEFFICIENT

| | | |
|----|---------|-----|
| CC | SB321CC | 5,1 |
| SS | SB321SS | 6,4 |
| NP | SB321NP | 6,1 |
| OS | SB321OS | 8,2 |
| RS | SB321RS | 7,7 |
| ON | SB321ON | 5,1 |

PACKAGING

 L: 210 mm
D: 130 mm
H: 70 mm

0,5 kg

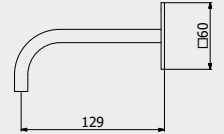

PORTATE | WATER FLOW | DÉBIT D'EAU

| | | |
|--------|--------|----------|
| 1 BAR | 2 BAR | 3 BAR |
| 10 l/m | 11 l/m | 12,5 l/m |

ARTICLE | ARTICOLO | ARTICLE

SB322



Long wall mounted spout

Bocca d'erogazione lunga a parete

Bec de remplissage mural long

CODICE / COEFFICIENTE | CODE /
COEFFICIENT | CODE / COEFFICIENT

| | | |
|----|---------|-----|
| CC | SB322CC | 5,1 |
| SS | SB322SS | 6,4 |
| NP | SB322NP | 6,1 |
| OS | SB322OS | 8,2 |
| RS | SB322RS | 7,7 |
| ON | SB322ON | 5,1 |

PACKAGING

 L: 210 mm
D: 130 mm
H: 70 mm

0,5 kg

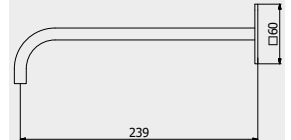

PORTATE | WATER FLOW | DÉBIT D'EAU

| | | |
|--------|--------|----------|
| 1 BAR | 2 BAR | 3 BAR |
| 10 l/m | 11 l/m | 12,5 l/m |

ARTICLE | ARTICOLO | ARTICLE

SB706



Exposed parts for bidet spray complete with mixer

Set di parti esterne per Idroscopino igienico con miscelatore

Partie extérieure pour douchette hygiénique avec mitigeur

CODICE / COEFFICIENTE | CODE /
COEFFICIENT | CODE / COEFFICIENT

| | | |
|----|----------|------|
| CC | ESB706CC | 9,8 |
| SS | ESB706SS | 12,3 |
| NP | ESB706NP | 11,8 |
| OS | ESB706OS | 15,7 |
| RS | ESB706RS | 14,7 |
| ON | ESB706ON | 9,8 |

PACKAGING

 L: 370 mm
D: 270 mm
H: 80 mm

3,1 kg

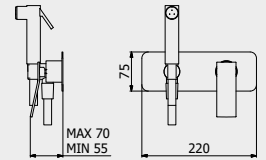

PORTATE | WATER FLOW | DÉBIT D'EAU

| | | |
|--------|--------|--------|
| 1 BAR | 2 BAR | 3 BAR |
| 10 l/m | 14 l/m | 17 l/m |

Built-in body to be purchased separately

Corpo incasso da acquistare separatamente

Corps intégré à acheter séparément



CODICE | CODE | CODE

INC206XXXN_19

COEFFICIENTE | COEFFICIENT | COEFFICIENT

2,9



ARTICLE | ARTICOLO | ARTICLE

SB370



Single Lever kitchen mixer

Miscelatore lavello monoforo

Évier de cuisine

CODICE / COEFFICIENTE | CODE /
COEFFICIENT | CODE / COEFFICIENT

| | | |
|----|---------|------|
| CC | SB370CC | 12,8 |
| SS | SB370SS | 16,0 |
| NP | SB370NP | 15,4 |
| OS | SB370OS | 20,5 |
| RS | SB370RS | 19,2 |
| ON | SB370ON | 12,8 |

PACKAGING

 L: 400 mm
D: 250 mm
H: 140 mm

2,8 kg

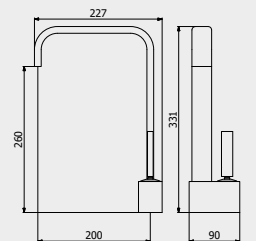

PORTATE | WATER FLOW | DÉBIT D'EAU

| | | |
|--------|--------|--------|
| 1 BAR | 2 BAR | 3 BAR |
| 10 l/m | 14 l/m | 17 l/m |



SNATCH / ACCESSORIES COLLECTION

ARTICLE | ARTICOLO | ARTICLE

HJ001



Wall soap-holder
Porta sapone a muro
Porte distributeur de savon encastré

CODICE / COEFFICIENTE | CODE / COEFFICIENT

| | | |
|----|---------|-----|
| CC | HJ001CC | 5,5 |
| SS | HJ001SS | 5,7 |
| BO | HJ001BO | 5,7 |
| NP | HJ001NP | 5,7 |
| CF | HJ001CF | 5,7 |
| CS | HJ001CS | 5,7 |
| II | HJ001II | 5,7 |
| IS | HJ001IS | 5,7 |
| RS | HJ001RS | 5,7 |
| SR | HJ001SR | 5,7 |
| OO | HJ001OO | 5,7 |
| OS | HJ001OS | 5,7 |

PACKAGING

| | | | |
|--|------------------------------------|--|--------|
| | L: 150 mm D: 190 mm H: 98 mm | | 0,4 kg |
|--|------------------------------------|--|--------|

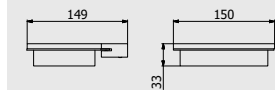

ARTICLE | ARTICOLO | ARTICLE

HJ003



Wall toothbrush holder
Porta spazzolino a muro
Porte brosse à dents encastré

CODICE / COEFFICIENTE | CODE / COEFFICIENT

| | | |
|----|---------|-----|
| CC | HJ003CC | 6,1 |
| SS | HJ003SS | 6,3 |
| BO | HJ003BO | 6,3 |
| NP | HJ003NP | 6,3 |
| CF | HJ003CF | 6,3 |
| CS | HJ003CS | 6,3 |
| II | HJ003II | 6,3 |
| IS | HJ003IS | 6,3 |
| RS | HJ003RS | 6,3 |
| SR | HJ003SR | 6,3 |
| OO | HJ003OO | 6,3 |
| OS | HJ003OS | 6,3 |

PACKAGING

| | | | |
|--|------------------------------------|--|--------|
| | L: 175 mm D: 125 mm H: 90 mm | | 0,2 kg |
|--|------------------------------------|--|--------|

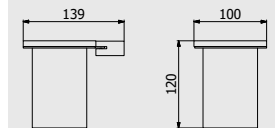

ARTICLE | ARTICOLO | ARTICLE

HJ016



Soap dispenser
Porta sapone da appoggio
Porte distributeur de savon

CODICE / COEFFICIENTE | CODE / COEFFICIENT

| | | |
|----|---------|-----|
| CC | HJ016CC | 2,2 |
| SS | HJ016SS | 2,4 |
| BO | HJ016BO | 2,4 |
| NP | HJ016NP | 2,4 |
| CF | HJ016CF | 2,4 |
| CS | HJ016CS | 2,4 |
| II | HJ016II | 2,4 |
| IS | HJ016IS | 2,4 |
| RS | HJ016RS | 2,4 |
| SR | HJ016SR | 2,4 |
| OO | HJ016OO | 2,4 |
| OS | HJ016OS | 2,4 |

PACKAGING

| | | | |
|--|------------------------------------|--|--------|
| | L: 150 mm D: 190 mm H: 98 mm | | 1,1 kg |
|--|------------------------------------|--|--------|

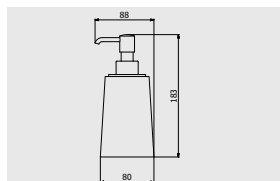

ARTICLE | ARTICOLO | ARTICLE

HJ017



Soap holder
Porta sapone da appoggio
Porte savon

CODE / COEFFICIENT | CODE / COEFFICIENT

| | | |
|----|---------|-----|
| CC | HJ017CC | 3,8 |
|----|---------|-----|

PACKAGING

| | | | |
|--|------------------------------------|--|--------|
| | L: 175 mm D: 125 mm H: 90 mm | | 0,5 kg |
|--|------------------------------------|--|--------|

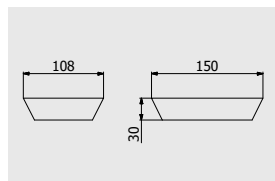

ARTICLE | ARTICOLO | ARTICLE

HJ010

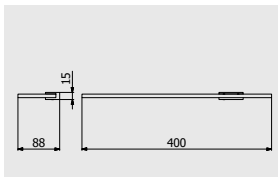

Shelf

Mensola

Étagère

CODICE / COEFFICIENTE | CODE /
COEFFICIENT | CODE / COEFFICIENT

| | | |
|----|---------|-----|
| CC | HJ010CC | 5,1 |
| SS | HJ010SS | 5,3 |
| BO | HJ010BO | 5,3 |
| NP | HJ010NP | 5,3 |
| CF | HJ010CF | 5,3 |
| CS | HJ010CS | 5,3 |
| II | HJ010II | 5,3 |
| IS | HJ010IS | 5,3 |
| RS | HJ010RS | 5,3 |
| SR | HJ010SR | 5,3 |
| OO | HJ010OO | 5,3 |
| OS | HJ010OS | 5,3 |

PACKAGING

| | | | |
|---|-----------|---|--------|
| 📦 | L: 175 mm | 📦 | 0,4 kg |
| | D: 125 mm | | |
| | H: 90 mm | | |

ARTICLE | ARTICOLO | ARTICLE

HJ011

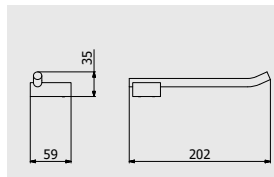

Toilet paper holder

Porta rotolo

Porte rouleaux de toilette

CODICE / COEFFICIENTE | CODE /
COEFFICIENT | CODE / COEFFICIENT

| | | |
|----|---------|-----|
| CC | HJ011CC | 3,5 |
| SS | HJ011SS | 4,4 |
| BO | HJ011BO | 4,4 |
| NP | HJ011NP | 4,2 |
| CF | HJ011CF | 5,3 |
| CS | HJ011CS | 5,7 |
| II | HJ011II | 5,3 |
| IS | HJ011IS | 5,7 |
| RS | HJ011RS | 5,3 |
| SR | HJ011SR | 5,7 |
| OO | HJ011OO | 5,7 |
| OS | HJ011OS | 5,3 |

PACKAGING

| | | | |
|---|-----------|---|--------|
| 📦 | L: 150 mm | 📦 | 0,7 kg |
| | D: 100 mm | | |
| | H: 70 mm | | |

ARTICLE | ARTICOLO | ARTICLE

HJ009

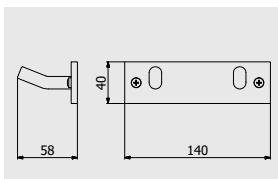

Double robe hook

Doppio appendino a parete

Double cintre

CODICE / COEFFICIENTE | CODE /
COEFFICIENT | CODE / COEFFICIENT

| | | |
|----|---------|-----|
| CC | HJ009CC | 3,4 |
| SS | HJ009SS | 4,3 |
| BO | HJ009BO | 4,3 |
| NP | HJ009NP | 4,3 |
| CF | HJ009CF | 5,1 |
| CS | HJ009CS | 5,4 |
| II | HJ009II | 5,4 |
| IS | HJ009IS | 5,4 |
| RS | HJ009RS | 5,1 |
| SR | HJ009SR | 5,4 |
| OO | HJ009OO | 5,1 |
| OS | HJ009OS | 5,4 |

PACKAGING

| | | | |
|---|-----------|---|--------|
| 📦 | L: 150 mm | 📦 | 0,4 kg |
| | D: 100 mm | | |
| | H: 70 mm | | |

ARTICLE | ARTICOLO | ARTICLE

HJ004

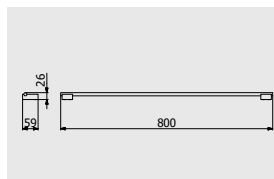

Towel holder

Porta salvietta

Porte-serviette

CODICE / COEFFICIENTE | CODE /
COEFFICIENT | CODE / COEFFICIENT

| | | |
|----|---------|------|
| CC | HJ004CC | 7,5 |
| SS | HJ004SS | 9,4 |
| BO | HJ004BO | 9,4 |
| NP | HJ004NP | 9,4 |
| CF | HJ004CF | 11,3 |
| CS | HJ004CS | 12,0 |
| II | HJ004II | 11,3 |
| IS | HJ004IS | 12,0 |
| RS | HJ004RS | 11,3 |
| SR | HJ004SR | 12,0 |
| OO | HJ004OO | 11,3 |
| OS | HJ004OS | 12,0 |

PACKAGING

| | | | |
|---|-----------|---|--------|
| 📦 | L: 782 mm | 📦 | 1,9 kg |
| | D: 135 mm | | |
| | H: 80 mm | | |

ARTICLE | ARTICOLO | ARTICLE

HJ014

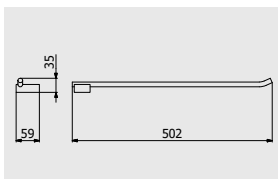

Towel holder

Porta salvietta

Porte-serviette

CODICE / COEFFICIENTE | CODE /
COEFFICIENT | CODE / COEFFICIENT

| | | |
|----|---------|-----|
| CC | HJ014CC | 5,1 |
| SS | HJ014SS | 6,4 |
| BO | HJ014BO | 6,4 |
| NP | HJ014NP | 6,4 |
| CF | HJ014CF | 7,7 |
| CS | HJ014CS | 8,2 |
| II | HJ014II | 7,7 |
| IS | HJ014IS | 8,2 |
| RS | HJ014RS | 7,7 |
| SR | HJ014SR | 8,2 |
| OO | HJ014OO | 7,7 |
| OS | HJ014OS | 8,2 |

PACKAGING

| | | | |
|---|-----------|---|--------|
| 📦 | L: 100 mm | 📦 | 1,1 kg |
| | D: 100 mm | | |
| | H: 50 mm | | |

ARTICLE | ARTICOLO | ARTICLE

HJ006

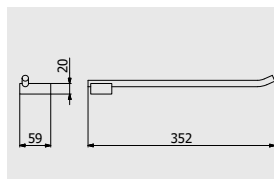

Towel holder

Porta salvietta

Porte-serviette

CODICE / COEFFICIENTE | CODE /
COEFFICIENT | CODE / COEFFICIENT

| | | |
|----|---------|-----|
| CC | HJ006CC | 4,9 |
| SS | HJ006SS | 6,1 |
| BO | HJ006BO | 6,1 |
| NP | HJ006NP | 6,1 |
| CF | HJ006CF | 7,4 |
| CS | HJ006CS | 7,8 |
| II | HJ006II | 7,4 |
| IS | HJ006IS | 7,8 |
| RS | HJ006RS | 7,4 |
| SR | HJ006SR | 7,8 |
| OO | HJ006OO | 7,4 |
| OS | HJ006OS | 7,8 |

PACKAGING

| | | | |
|---|-----------|---|--------|
| 📦 | L: 175 mm | 📦 | 0,9 kg |
| | D: 125 mm | | |
| | H: 90 mm | | |



ARTICLE | ARTICOLO | ARTICLE

HJ007

Ring Towel holder

Porta salvietta ad anello

Porte-serviette anneau

CODICE / COEFFICIENTE | CODE / COEFFICIENT

| | | |
|----|---------|-----|
| CC | HJ007CC | 5,0 |
| SS | HJ007SS | 6,3 |
| BO | HJ007BO | 6,3 |
| NP | HJ007NP | 6,3 |
| CF | HJ007CF | 7,5 |
| CS | HJ007CS | 8,0 |
| II | HJ007II | 7,5 |
| IS | HJ007IS | 8,0 |
| RS | HJ007RS | 7,5 |
| SR | HJ007SR | 8,0 |
| OO | HJ007OO | 7,5 |
| OS | HJ007OS | 8,0 |

PACKAGING

| | | | |
|--|-----------|--|--------|
| | L: 340 mm | | 1,9 kg |
| | D: 180 mm | | |
| | H: 70 mm | | |

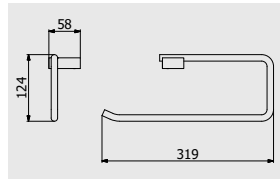

ARTICLE | ARTICOLO | ARTICLE

HJ012

Toilet brush holder

Porta scopino da terra

Porte balayette au sol

CODICE / COEFFICIENTE | CODE / COEFFICIENT

| | | |
|----|---------|------|
| CC | HJ012CC | 7,8 |
| SS | HJ012SS | 9,8 |
| BO | HJ012BO | 9,8 |
| NP | HJ012NP | 9,8 |
| CF | HJ012CF | 11,7 |
| CS | HJ012CS | 12,5 |
| II | HJ012II | 11,7 |
| IS | HJ012IS | 12,5 |
| RS | HJ012RS | 11,7 |
| SR | HJ012SR | 12,5 |
| OO | HJ012OO | 11,7 |
| OS | HJ012OS | 12,5 |

PACKAGING

| | | | |
|--|-----------|--|--------|
| | L: 100 mm | | 1,8 kg |
| | D: 100 mm | | |
| | H: 50 mm | | |

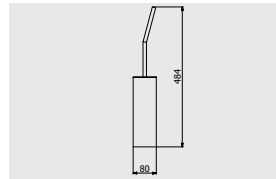

ARTICLE | ARTICOLO | ARTICLE

HJ015

Toothbrush holder

Porta spazzolino

Porte brosse à dents

CODICE / COEFFICIENTE | CODE / COEFFICIENT

| | | |
|----|---------|-----|
| CC | HJ015CC | 2,8 |
|----|---------|-----|

PACKAGING

| | | | |
|--|-----------|--|--------|
| | L: 175 mm | | 0,6 kg |
| | D: 125 mm | | |
| | H: 90 mm | | |

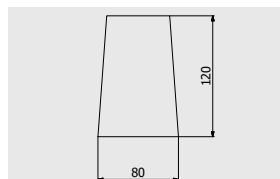

ARTICLE | ARTICOLO | ARTICLE

HJ018

Box

Scatola

Boîte

CODICE / COEFFICIENTE | CODE / COEFFICIENT

| | | |
|----|---------|-----|
| CC | HJ018CC | 4,1 |
| SS | HJ018SS | 4,3 |
| BO | HJ018BO | 4,3 |
| NP | HJ018NP | 4,3 |
| CF | HJ018CF | 4,3 |
| CS | HJ018CS | 4,3 |
| II | HJ018II | 4,3 |
| IS | HJ018IS | 4,3 |
| RS | HJ018RS | 4,3 |
| SR | HJ018SR | 4,3 |
| OO | HJ018OO | 4,3 |
| OS | HJ018OS | 4,3 |

PACKAGING

| | | | |
|--|-----------|--|--------|
| | L: 240 mm | | 1,2 kg |
| | D: 215 mm | | |
| | H: 110 mm | | |

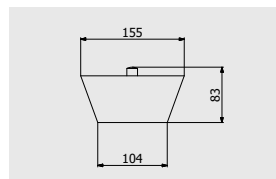

Superbox

MILANOTORINO

Simple and versatile shapes as a trait of strength and identity without equal.

Forme semplici e versatili come tratto di forza e identità senza eguali.
Formes simples et polyédriques un trait de force et d'identité sans égaux.

Two great eclectic cities, two Italian cultural and economical capitals, two original and a little bit crazy souls, joined in the name of a famous cocktail with a strong and uncompromised flavour. From the name of the aperitif with an intense character and flavour, the vigorous and audacious MILANOTORINO collection is born, whose versatility becomes a trait of strength and identity without equal.

Due grandi città eclettiche, due capitali della cultura e dell'economia italiana, due anime originali e un poco pazzes, unite nel nome di un famoso cocktail dal sapore forte e senza compromessi. Dal nome dell'aperitivo dal carattere e dal sapore intensi, nasce una collezione vigorosa e audace, che fa della sua poliedricità un tratto di forza e di identità senza eguali.

Deux grandes villes éclectiques, deux capitales de la culture et de l'économie italiennes, deux âmes originales et un peu folles, réunies dans le nom d'un célèbre cocktail à la saveur résolue et sans compromis. Du nom de l'apéritif au caractère et à la saveur intenses est née une collection vigoureuse et audacieuse, qui fait de son essence polyédrique un trait de force et d'identité sans égaux.



KITCHEN
AVAILABLE



CRYSTAL CLEAR
WATER



LEAD FREE



ZINC FREE





Milano
Torino

DESIGN
ANDREA + DAVIDE BREGOLI



- ↑ **MT200CC**
Monohole washbasin mixer
Miscelatore lavabo monoforo
Mitigeur lavabo
- ↙ **MT220CC**
Monohole bidet mixer
Miscelatore bidet monoforo
Mitigeur bidet
- **MT202CC**
Tall monohole washbasin mixer
Miscelatore lavabo monoforo alto
Mitigeur lavabo haut



Milano
Torino



↑ MT200CC
Monohole washbasin mixer
Miscelatore lavabo monoforo
Mitigeur lavabo



Milano
Torino

← MT299CC
Monohole free-standing washbasin mixer
complete with drain
Miscelatore lavabo da terra completo di
scarico automatico
Mitigeur Lavabo Free standing complet avec
bonde automatique

↑ MT202CC
Tall monohole washbasin mixer
Miscelatore lavabo monoforo alto
Mitigeur lavabo haut



- MT201SS
Mini monohole washbasin mixer
Miscelatore lavabo monoforo mini
Mitigeur lavabo mini
- ↙ MT206CC
Wall mounted washbasin mixer
Miscelatore lavabo due fori a parete
Mitigeur lavabo mural



Milano
Torino





← **MT299CC**
Monohole free-standing washbasin mixer
Miscelatore lavabo da terra
Mitigeur lavabo free standing

↑ **MT392CC**
Three holes washbasin set with low spout
Lavabo tre fori a bocca bassa
Lavabo trois trous bec bas

→ **MT314CC**
Three ways wall shower mixer complete with shower kit
Miscelatore doccia a parete con deviatore tre vie e doccino integrato
Mitigeur douche mural trois voies avec inverseur et douchette encastrée



Milano
Torino



- ↑ **MT250CC**
 Wall mounted bath filler complete with hand shower kit
 Bordo vasca esterno a parete completo di kit doccia
 Mitigeur Bain/douche Mural avec douchette encastrée
- ← **MT706CC**
 Exposed parts for bidet spray complete with mixer
 Set di parti esterne per Idroscopino igienico con miscelatore
 Partie extérieure pour douchette hygiénique avec mitigeur
- **MT350CC**
 Wall mounted bath filler complete with hand shower kit
 Bordo vasca esterno a parete completo di kit doccia
 Mitigeur Bain/douche Mural avec douchette encastrée



Milano
Torino

ARTICLE | ARTICOLO | ARTICLE

MT200



Monohole washbasin mixer complete with drain

Miscelatore lavabo monoforo completo di scarico automatico

Mitigeur Lavabo complet avec bonde automatique

| CODE / COEFFICIENT | CODICE / COEFFICIENTE | CODE / COEFFICIENT |
|--------------------|-----------------------|--------------------|
| CC | MT200CC | 6,0 |
| SS | MT200SS | 7,5 |
| ON | MT200ON | 6,0 |
| BO | MT200BO | 7,2 |
| NP | MT200NP | 7,2 |
| CF | MT200CF | 9,0 |
| CS | MT200CS | 9,6 |
| II | MT200II | 9,0 |
| IS | MT200IS | 9,6 |
| RS | MT200RS | 9,0 |
| SR | MT200SR | 9,6 |
| OO | MT200OO | 9,0 |
| OS | MT200OS | 9,6 |

PACKAGING

L: 340 mm
D: 180 mm
H: 70 mm

1,6 kg

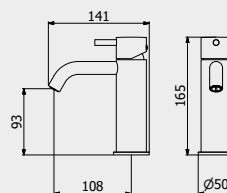

PORTATE | WATER FLOW | DÉBIT D'EAU

| 1 BAR | 2 BAR | 3 BAR |
|---------|-------|--------|
| 6,5 l/m | 9 l/m | 11 l/m |

ARTICLE | ARTICOLO | ARTICLE

MT201



Mini monohole washbasin mixer complete with drain

Miscelatore lavabo monoforo mini completo di scarico automatico

Mitigeur lavabo Mini complet avec bonde automatique

| CODE / COEFFICIENT | CODICE / COEFFICIENTE | CODE / COEFFICIENT |
|--------------------|-----------------------|--------------------|
| CC | MT201CC | 4,9 |
| SS | MT201SS | 6,1 |
| ON | MT201ON | 4,9 |
| BO | MT201BO | 5,9 |
| NP | MT201NP | 5,9 |
| CF | MT201CF | 7,4 |
| CS | MT201CS | 7,8 |
| II | MT201II | 7,4 |
| IS | MT201IS | 7,8 |
| RS | MT201RS | 7,4 |
| SR | MT201SR | 7,8 |
| OO | MT201OO | 7,4 |
| OS | MT201OS | 7,8 |

PACKAGING

L: 340 mm
D: 180 mm
H: 70 mm

1,2 kg

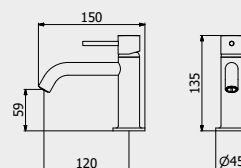

PORTATE | WATER FLOW | DÉBIT D'EAU

| 1 BAR | 2 BAR | 3 BAR |
|---------|---------|---------|
| 4,5 l/m | 6,4 l/m | 7,5 l/m |

ARTICLE | ARTICOLO | ARTICLE

MT202



Tall monohole washbasin mixer complete with drain

Miscelatore lavabo monoforo alto completo di scarico automatico

Mitigeur lavabo Haut complet avec bonde automatique

| CODE / COEFFICIENT | CODICE / COEFFICIENTE | CODE / COEFFICIENT |
|--------------------|-----------------------|--------------------|
| CC | MT202CC | 9,4 |
| SS | MT202SS | 11,8 |
| ON | MT202ON | 9,4 |
| BO | MT202BO | 11,3 |
| NP | MT202NP | 11,3 |
| CF | MT202CF | 14,1 |
| CS | MT202CS | 15,0 |
| II | MT202II | 14,1 |
| IS | MT202IS | 15,0 |
| RS | MT202RS | 14,1 |
| SR | MT202SR | 15,0 |
| OO | MT202OO | 14,1 |
| OS | MT202OS | 15,0 |

PACKAGING

L: 425 mm
D: 188 mm
H: 98 mm

2,3 kg

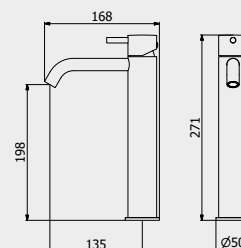

PORTATE | WATER FLOW | DÉBIT D'EAU

| 1 BAR | 2 BAR | 3 BAR |
|---------|---------|----------|
| 6,4 l/m | 8,9 l/m | 10,9 l/m |

ARTICLE | ARTICOLO | ARTICLE

MT203



Tall mini monohole washbasin mixer complete with drain

Miscelatore lavabo monoforo alto mini completo di scarico automatico

Mitigeur Lavabo haut Mini complet avec bonde automatique

| CODE / COEFFICIENT | CODICE / COEFFICIENTE | CODE / COEFFICIENT |
|--------------------|-----------------------|--------------------|
| CC | MT203CC | 6,4 |
| SS | MT203SS | 8,0 |
| ON | MT203ON | 6,4 |
| BO | MT203BO | 7,7 |
| NP | MT203NP | 7,7 |
| CF | MT203CF | 9,6 |
| CS | MT203CS | 10,2 |
| II | MT203II | 9,6 |
| IS | MT203IS | 10,2 |
| RS | MT203RS | 9,6 |
| SR | MT203SR | 10,2 |
| OO | MT203OO | 9,6 |
| OS | MT203OS | 10,2 |

PACKAGING

L: 370 mm
D: 270 mm
H: 80 mm

1,8 kg

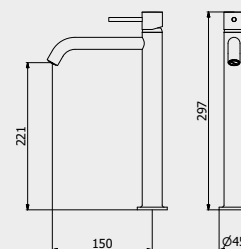

PORTATE | WATER FLOW | DÉBIT D'EAU

| 1 BAR | 2 BAR | 3 BAR |
|---------|---------|---------|
| 4,5 l/m | 6,5 l/m | 7,8 l/m |



ARTICLE | ARTICOLO | ARTICLE

MT206



Wall mounted washbasin mixer complete with drain
Miscelatore lavabo due fori a parete completo di scarico automatico
Mitigeur lavabo mural complet avec bonde automatique

| CODE / COEFFICIENT CODICE / COEFFICIENTE CODE / COEFFICIENT | |
|---|------|
| CC EMT206CC | 7,9 |
| SS EMT206SS | 9,9 |
| ON EMT206ON | 7,9 |
| BO EMT206BO | 9,5 |
| NP EMT206NP | 9,5 |
| CF EMT206CF | 11,9 |
| CS EMT206CS | 12,6 |
| II EMT206II | 11,9 |
| IS EMT206IS | 12,6 |
| RS EMT206RS | 11,9 |
| SR EMT206SR | 12,6 |
| OO EMT206OO | 11,9 |
| OS EMT206OS | 12,6 |

PACKAGING

L: 265 mm
D: 260 mm
H: 70 mm
1,2 kg

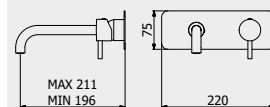

PORTATE | WATER FLOW | DÉBIT D'EAU

| | | |
|---------|----------|--------|
| 1 BAR | 2 BAR | 3 BAR |
| 7,6 l/m | 10,5 l/m | 13 l/m |

Built-in body to be purchased separately

Corpo incasso da acquistare separatamente
Corps intégré à acheter séparément



CODICE | CODE | CODE

INC206XXXN_19

COEFFICIENTE | COEFFICIENT | COEFFICIENT

2,9



ARTICLE | ARTICOLO | ARTICLE

MT207



Wall mounted washbasin mixer with long spout complete with drain
Miscelatore lavabo due fori a parete con bocca lunga completo di scarico
Mitigeur lavabo mural bec long complet avec bonde automatique

| CODE / COEFFICIENT CODICE / COEFFICIENTE CODE / COEFFICIENT | |
|---|------|
| CC EMT207CC | 9,6 |
| SS EMT207SS | 12,0 |
| ON EMT207ON | 9,6 |
| BO EMT207BO | 11,5 |
| NP EMT207NP | 11,5 |
| CF EMT207CF | 14,4 |
| CS EMT207CS | 15,4 |
| II EMT207II | 14,4 |
| IS EMT207IS | 15,4 |
| RS EMT207RS | 14,4 |
| SR EMT207SR | 15,4 |
| OO EMT207OO | 14,4 |
| OS EMT207OS | 15,4 |

PACKAGING

L: 265 mm
D: 260 mm
H: 70 mm
1,2 kg

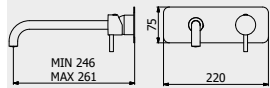

PORTATE | WATER FLOW | DÉBIT D'EAU

| | | |
|---------|----------|--------|
| 1 BAR | 2 BAR | 3 BAR |
| 7,6 l/m | 10,5 l/m | 13 l/m |

Built-in body to be purchased separately

Corpo incasso da acquistare separatamente
Corps intégré à acheter séparément



CODICE | CODE | CODE

INC206XXXN_19

COEFFICIENTE | COEFFICIENT | COEFFICIENT

2,9



ARTICLE | ARTICOLO | ARTICLE

MT208



Wall mounted washbasin mixer with short spout complete with drain
Miscelatore lavabo due fori a parete con bocca corta completo di scarico
Mitigeur lavabo mural bec court complet avec bonde automatique

| CODE / COEFFICIENT CODICE / COEFFICIENTE CODE / COEFFICIENT | |
|---|------|
| CC EMT208CC | 9,6 |
| SS EMT208SS | 12,0 |
| ON EMT208ON | 9,6 |
| BO EMT208BO | 11,5 |
| NP EMT208NP | 11,5 |
| CF EMT208CF | 14,4 |
| CS EMT208CS | 15,4 |
| II EMT208II | 14,4 |
| IS EMT208IS | 15,4 |
| RS EMT208RS | 14,4 |
| SR EMT208SR | 15,4 |
| OO EMT208OO | 14,4 |
| OS EMT208OS | 15,4 |

PACKAGING

L: 265 mm
D: 260 mm
H: 70 mm
1,2 kg

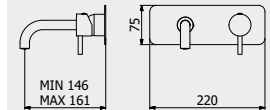

PORTATE | WATER FLOW | DÉBIT D'EAU

| | | |
|---------|----------|--------|
| 1 BAR | 2 BAR | 3 BAR |
| 7,6 l/m | 10,5 l/m | 13 l/m |

Built-in body to be purchased separately

Corpo incasso da acquistare separatamente
Corps intégré à acheter séparément



CODICE | CODE | CODE

INC206XXXN_19

COEFFICIENTE | COEFFICIENT | COEFFICIENT

2,9

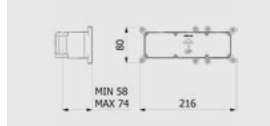

Milano
Torino

ARTICLE | ARTICOLO | ARTICLE

MT210



Ceiling spout with wall mounted mixer

Bocca da soffitto con comando remoto ad incasso

Mitigeur lavabo mural avec bec plafond complet avec bonde automatique

| CODICE / COEFFICIENTE | CODE / COEFFICIENT | |
|-----------------------|--------------------|------|
| CC | EMT210CC | 27,5 |
| BO | EMT210BO | 33,0 |
| NP | EMT210NP | 33,0 |

PACKAGING

L: 150 mm
D: 190 mm
H: 98 mm

L: 1700 mm
Ø: 70 mm

4,5 kg

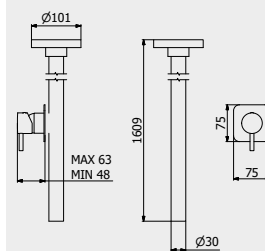
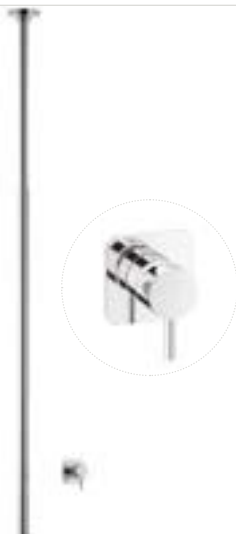

PORTATE | WATER FLOW | DÉBIT D'EAU

| 1 BAR | 2 BAR | 3 BAR |
|---------|---------|-------|
| 4,3 l/m | 5,2 l/m | 7 l/m |

Built-in body to be purchased separately

Corpo incasso da acquistare separatamente

Corps intégré à acheter séparément



CODICE | CODE | CODE

INC300XXXN_19

COEFFICIENTE | COEFFICIENT | COEFFICIENT

1,8



ARTICLE | ARTICOLO | ARTICLE

MT299



Monohole free-standing washbasin mixer complete with drain

Miscelatore lavabo da terra completo di scarico automatico

Mitigeur lavabo free standing complet avec bonde automatique

| CODICE / COEFFICIENTE | CODE / COEFFICIENT | |
|-----------------------|--------------------|------|
| CC | EMT299CC | 27,6 |
| SS | EMT299SS | 34,5 |
| ON | EMT299ON | 27,6 |
| BO | EMT299BO | 33,1 |
| NP | EMT299NP | 33,1 |
| CF | EMT299CF | 41,4 |
| CS | EMT299CS | 44,2 |
| II | EMT299II | 41,4 |
| IS | EMT299IS | 44,2 |
| RS | EMT299RS | 41,4 |
| SR | EMT299SR | 44,2 |
| OO | EMT299OO | 41,4 |
| OS | EMT299OS | 44,2 |

PACKAGING

L: 1160 mm
D: 360 mm
H: 180 mm

13,8 kg

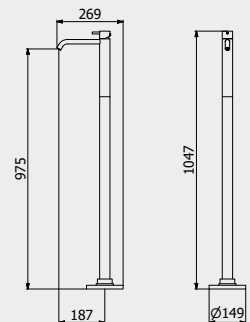

PORTATE | WATER FLOW | DÉBIT D'EAU

| 1 BAR | 2 BAR | 3 BAR |
|---------|---------|---------|
| 5,5 l/m | 7,8 l/m | 9,6 l/m |

Built-in body to be purchased separately
AVAILABLE FROM JANUARY 2020

Corpo incasso da acquistare separatamente
DISPONIBILE DA GENNAIO 2020

Corps intégré à acheter séparément
DISPONIBLE À PARTIR DE JANVIER 2020



CODICE | CODE | CODE

INC399XXXN_19

COEFFICIENTE | COEFFICIENT | COEFFICIENT

2,8

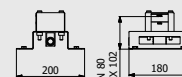

ARTICLE | ARTICOLO | ARTICLE

MT392



Three holes washbasin set with low spout

Lavabo tre fori a bocca bassa completo di scarico automatico

Lavabo trois trous bec bas

| CODICE / COEFFICIENTE | CODE / COEFFICIENT | |
|-----------------------|--------------------|------|
| CC | MT392CC | 11,5 |
| SS | MT392SS | 14,4 |
| ON | MT392ON | 11,5 |
| BO | MT392BO | 13,8 |
| NP | MT392NP | 13,8 |
| CF | MT392CF | 17,3 |
| CS | MT392CS | 18,4 |
| II | MT392II | 17,3 |
| IS | MT392IS | 18,4 |
| RS | MT392RS | 17,3 |
| SR | MT392SR | 18,4 |
| OO | MT392OO | 17,3 |
| OS | MT392OS | 18,4 |

PACKAGING

L: 370 mm
D: 270 mm
H: 80 mm

4,5 kg

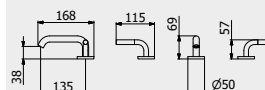

PORTATE | WATER FLOW | DÉBIT D'EAU

| 1 BAR | 2 BAR | 3 BAR |
|---------|-------|--------|
| 6,5 l/m | 9 l/m | 11 l/m |



ARTICLE | ARTICOLO | ARTICLE

MT220



Monohole bidet mixer complete with drain

Miscelatore bidet monoforo completo di scarico automatico

Mitigeur bidet complet avec bonde automatique

| CODE / COEFFICIENT | CODICE / COEFFICIENTE | COEFFICIENT |
|--------------------|-----------------------|-------------|
| CC | MT220CC | 6,0 |
| SS | MT220SS | 7,5 |
| ON | MT220ON | 6,0 |
| BO | MT220BO | 7,2 |
| NP | MT220NP | 7,2 |
| CF | MT220CF | 9,0 |
| CS | MT220CS | 9,6 |
| II | MT220II | 9,0 |
| IS | MT220IS | 9,6 |
| RS | MT220RS | 9,0 |
| SR | MT220SR | 9,6 |
| OO | MT220OO | 9,0 |
| OS | MT220OS | 9,6 |

PACKAGING

L: 340 mm
D: 180 mm
H: 70 mm

1,6 kg

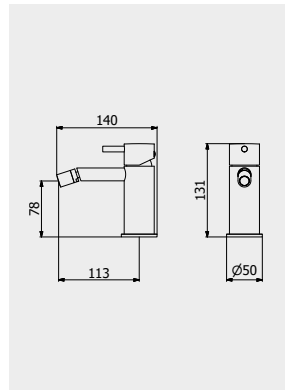

PORTATE | WATER FLOW | DÉBIT D'EAU

| 1 BAR | 2 BAR | 3 BAR |
|---------|-------|--------|
| 6,5 l/m | 9 l/m | 11 l/m |

ARTICLE | ARTICOLO | ARTICLE

MT223



Mini monohole bidet mixer complete with drain

Miscelatore bidet monoforo mini completo di scarico automatico

Mitigeur bidet complet avec bonde automatique

| CODE / COEFFICIENT | CODICE / COEFFICIENTE | COEFFICIENT |
|--------------------|-----------------------|-------------|
| CC | MT223CC | 4,9 |
| SS | MT223SS | 6,1 |
| ON | MT223ON | 4,9 |
| BO | MT223BO | 5,9 |
| NP | MT223NP | 5,9 |
| CF | MT223CF | 7,4 |
| CS | MT223CS | 7,8 |
| II | MT223II | 7,4 |
| IS | MT223IS | 7,8 |
| RS | MT223RS | 7,4 |
| SR | MT223SR | 7,8 |
| OO | MT223OO | 7,4 |
| OS | MT223OS | 7,8 |

PACKAGING

L: 340 mm
D: 180 mm
H: 70 mm

1,3 kg

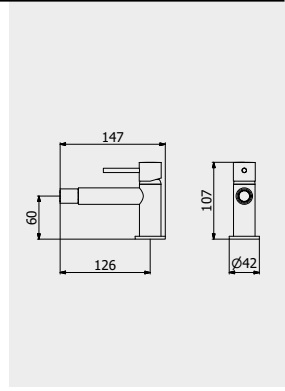

PORTATE | WATER FLOW | DÉBIT D'EAU

| 1 BAR | 2 BAR | 3 BAR |
|---------|---------|---------|
| 4,5 l/m | 6,5 l/m | 7,5 l/m |

Milano Torino

ARTICLE | ARTICOLO | ARTICLE

MT300



Exposed parts for manual wall mixer

Set di parti esterne per miscelatore a parete ad una via

Partie extérieure pour mitigeur encastré à une voie

| CODE / COEFFICIENT | CODICE / COEFFICIENTE | COEFFICIENT |
|--------------------|-----------------------|-------------|
| CC | EMT300CC | 4,1 |
| SS | EMT300SS | 5,1 |
| ON | EMT300ON | 4,1 |
| BO | EMT300BO | 4,9 |
| NP | EMT300NP | 4,9 |
| CF | EMT300CF | 6,2 |
| CS | EMT300CS | 6,6 |
| II | EMT300II | 6,2 |
| IS | EMT300IS | 6,6 |
| RS | EMT300RS | 6,2 |
| SR | EMT300SR | 6,6 |
| OO | EMT300OO | 6,2 |
| OS | EMT300OS | 6,6 |

PACKAGING

L: 150 mm
D: 190 mm
H: 98 mm

1,2 kg

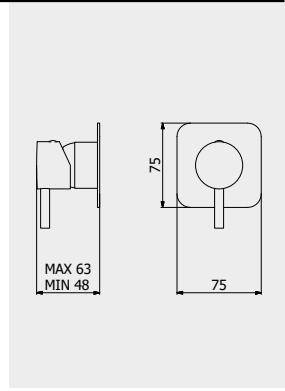

PORTATE | WATER FLOW | DÉBIT D'EAU

| 1 BAR | 2 BAR | 3 BAR |
|----------|----------|--------|
| 11,5 l/m | 16,3 l/m | 20 l/m |

Built-in body to be purchased separately

Corpo incasso da acquistare separatamente

Corps intégré à acheter séparément



CODICE | CODE | CODE

INC300XXXN_19

COEFFICIENTE | COEFFICIENT | COEFFICIENT

1,8

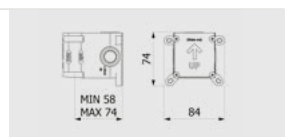

ARTICLE | ARTICOLO | ARTICLE

MT310



Exposed parts for manual wall mixer with two ways diverter
Miscelatore doccia a parete con deviatore due vie
Mitigeur douche mural deux voies avec inverseur

| CODE / COEFFICIENTE | CODICE / COEFFICIENTE | |
|---------------------|-----------------------|-----|
| CC | EMT310CC | 6,1 |
| SS | EMT310SS | 7,6 |
| ON | EMT310ON | 6,1 |
| BO | EMT310BO | 7,3 |
| NP | EMT310NP | 7,3 |
| CF | EMT310CF | 9,2 |
| CS | EMT310CS | 9,8 |
| II | EMT310II | 9,2 |
| IS | EMT310IS | 9,8 |
| RS | EMT310RS | 9,2 |
| SR | EMT310SR | 9,8 |
| OO | EMT310OO | 9,2 |
| OS | EMT310OS | 9,8 |

PACKAGING

L: 150 mm
D: 190 mm
H: 98 mm

1,2 kg

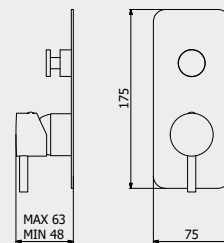

PORTATE | WATER FLOW | DÉBIT D'EAU

| | | |
|---------|----------|--------|
| 1 BAR | 2 BAR | 3 BAR |
| 9,2 l/m | 12,8 l/m | 16 l/m |

Built-in body to be purchased separately

Corpo incasso da acquistare separatamente

Corps intégré à acheter séparément



CODICE | CODE | CODE

INC310XXXN_19

COEFFICIENTE | COEFFICIENT | COEFFICIENT

3,3

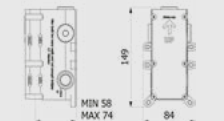

ARTICLE | ARTICOLO | ARTICLE

MT312



Exposed parts for manual wall mixer with three ways diverter
Set di parti esterne per miscelatore a parete a tre vie
Mitigeur douche mural trois voies avec inverseur

| CODE / COEFFICIENTE | CODICE / COEFFICIENTE | |
|---------------------|-----------------------|------|
| CC | EMT312CC | 7,4 |
| SS | EMT312SS | 9,3 |
| ON | EMT312ON | 7,4 |
| BO | EMT312BO | 8,9 |
| NP | EMT312NP | 8,9 |
| CF | EMT312CF | 11,1 |
| CS | EMT312CS | 11,8 |
| II | EMT312II | 11,1 |
| IS | EMT312IS | 11,8 |
| RS | EMT312RS | 11,1 |
| SR | EMT312SR | 11,8 |
| OO | EMT312OO | 11,1 |
| OS | EMT312OS | 11,8 |

PACKAGING

L: 150 mm
D: 190 mm
H: 98 mm

1,2 kg

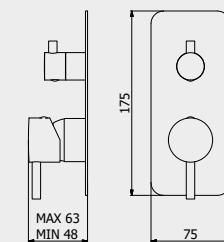

PORTATE | WATER FLOW | DÉBIT D'EAU

| | | |
|---------|----------|----------|
| 1 BAR | 2 BAR | 3 BAR |
| 8,3 l/m | 11,7 l/m | 14,3 l/m |

Built-in body to be purchased separately

Corpo incasso da acquistare separatamente

Corps intégré à acheter séparément



CODICE | CODE | CODE

INC312XXXN_19

COEFFICIENTE | COEFFICIENT | COEFFICIENT

3,3

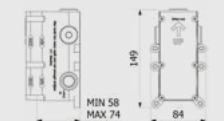

ARTICLE | ARTICOLO | ARTICLE

MT313



Exposed parts for manual wall mixer with 2 ways with shower kit
Set di parti esterne per miscelatore a parete a due vie completo di kit doccia
Partie extérieure pour mitigeur encastré à deux voies avec douchette

| CODE / COEFFICIENTE | CODICE / COEFFICIENTE | |
|---------------------|-----------------------|------|
| CC | EMT313CC | 10,1 |
| SS | EMT313SS | 12,6 |
| ON | EMT313ON | 10,1 |
| BO | EMT313BO | 12,1 |
| NP | EMT313NP | 12,1 |
| CF | EMT313CF | 15,2 |
| CS | EMT313CS | 16,2 |
| II | EMT313II | 15,2 |
| IS | EMT313IS | 16,2 |
| RS | EMT313RS | 15,2 |
| SR | EMT313SR | 16,2 |
| OO | EMT313OO | 15,2 |
| OS | EMT313OS | 16,2 |

PACKAGING

L: 370 mm
D: 270 mm
H: 80 mm

1,9 kg

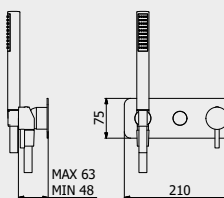

PORTATE | WATER FLOW | DÉBIT D'EAU

| | | |
|--------|----------|----------|
| 1 BAR | 2 BAR | 3 BAR |
| 10 l/m | 14,1 l/m | 17,2 l/m |

Built-in body to be purchased separately

Corpo incasso da acquistare separatamente

Corps intégré à acheter séparément



CODICE | CODE | CODE

INC313XXXN_19

COEFFICIENTE | COEFFICIENT | COEFFICIENT

3,6



ARTICLE | ARTICOLO | ARTICLE

MT314



Exposed parts for manual wall mixer with 3 ways with shower kit
Set di parti esterne per miscelatore a parete a tre vie completo di kit doccia
Partie extérieure pour mitigeur encastré à trois voies avec douchette

| CODE / COEFFICIENT | CODICE / COEFFICIENTE | COEFFICIENT |
|--------------------|-----------------------|-------------|
| CC | EMT314CC | 11,4 |
| SS | EMT314SS | 14,3 |
| ON | EMT314ON | 11,4 |
| BO | EMT314BO | 13,7 |
| NP | EMT314NP | 13,7 |
| CF | EMT314CF | 17,1 |
| CS | EMT314CS | 18,2 |
| II | EMT314II | 17,1 |
| IS | EMT314IS | 18,2 |
| RS | EMT314RS | 17,1 |
| SR | EMT314SR | 18,2 |
| OO | EMT314OO | 17,1 |
| OS | EMT313OS | 18,2 |

PACKAGING

L: 370 mm
D: 270 mm
H: 80 mm
1,9 kg

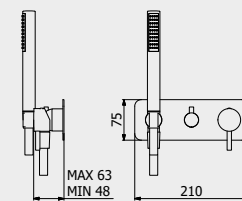

PORTATE | WATER FLOW | DÉBIT D'EAU

| | | |
|---------|----------|----------|
| 1 BAR | 2 BAR | 3 BAR |
| 8,3 l/m | 11,7 l/m | 14,3 l/m |

Built-in body to be purchased separately

Corpo incasso da acquistare separatamente

Corps intégré à acheter séparément



CODICE | CODE | CODE

INC314XXXN_19

COEFFICIENTE | COEFFICIENT | COEFFICIENT

3,7



ARTICLE | ARTICOLO | ARTICLE

MT610



Two ways wall shower thermostatic valve
Valvola termostatica doccia a parete con deviatore due vie
Valve thermostatique douche mural deux voies avec inverseur

| CODE / COEFFICIENT | CODICE / COEFFICIENTE | COEFFICIENT |
|--------------------|-----------------------|-------------|
| CC | EMT610CC | 10,4 |
| SS | EMT610SS | 13,0 |
| ON | EMT610ON | 10,4 |
| BO | EMT610BO | 12,5 |
| NP | EMT610NP | 12,5 |
| CF | EMT610CF | 15,6 |
| CS | EMT610CS | 16,6 |
| II | EMT610II | 15,6 |
| IS | EMT610IS | 16,6 |
| RS | EMT610RS | 15,6 |
| SR | EMT610SR | 16,6 |
| OO | EMT610OO | 15,6 |
| OS | EMT610OS | 16,6 |

PACKAGING

L: 150 mm
D: 190 mm
H: 98 mm
2,4 kg

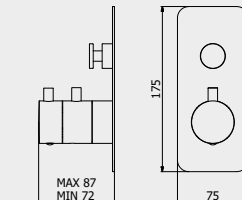

PORTATE | WATER FLOW | DÉBIT D'EAU

| | | |
|----------|----------|----------|
| 1 BAR | 2 BAR | 3 BAR |
| 11,6 l/m | 16,3 l/m | 20,1 l/m |

Built-in body to be purchased separately

Corpo incasso da acquistare separatamente

Corps intégré à acheter séparément



CODICE | CODE | CODE

INC310XXXN_19

COEFFICIENTE | COEFFICIENT | COEFFICIENT

3,3

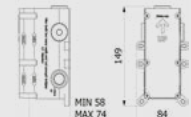

ARTICLE | ARTICOLO | ARTICLE

MT613



Two ways wall shower thermostatic valve complete with shower kit
Valvola termostatica doccia a parete con deviatore due vie e doccia integrato
Valve thermostatique douche mural deux voies avec inverseur et douchette

| CODE / COEFFICIENT | CODICE / COEFFICIENTE | COEFFICIENT |
|--------------------|-----------------------|-------------|
| CC | EMT613CC | 14,1 |
| SS | EMT613SS | 17,6 |
| ON | EMT613ON | 14,1 |
| BO | EMT613BO | 16,9 |
| NP | EMT613NP | 16,9 |
| CF | EMT613CF | 21,1 |
| CS | EMT613CS | 22,5 |
| II | EMT613II | 21,1 |
| IS | EMT613IS | 22,5 |
| RS | EMT613RS | 21,1 |
| SR | EMT613SR | 22,5 |
| OO | EMT613OO | 21,1 |
| OS | EMT613OS | 22,5 |

PACKAGING

L: 150 mm
D: 190 mm
H: 98 mm
2,4 kg

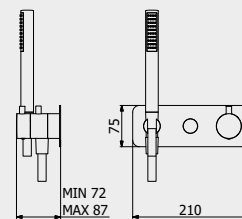

PORTATE | WATER FLOW | DÉBIT D'EAU

| | | |
|----------|----------|----------|
| 1 BAR | 2 BAR | 3 BAR |
| 11,6 l/m | 16,3 l/m | 20,1 l/m |

Built-in body to be purchased separately

Corpo incasso da acquistare separatamente

Corps intégré à acheter séparément



CODICE | CODE | CODE

INC313XXXN_19

COEFFICIENTE | COEFFICIENT | COEFFICIENT

3,6



Milano Torino

ARTICLE | ARTICOLO | ARTICLE

MT350



Wall mounted shower mixer with shower kit

Doccia esterno a parete completo di kit doccia

Mitigeur de douche externe avec flexible et douchette

CODE / COEFFICIENT | CODICE /
COEFFICIENTE | CODE / COEFFICIENT

| | | |
|------|---------|------|
| ● CC | MT350CC | 11,7 |
| ● SS | MT350SS | 14,6 |
| ● BO | MT350BO | 14,0 |
| ● NP | MT350NP | 14,0 |
| ● CF | MT350CF | 17,6 |
| ● CS | MT350CS | 18,7 |
| ● II | MT350II | 17,6 |
| ● IS | MT350IS | 18,7 |
| ● RS | MT350RS | 17,6 |
| ● SR | MT350SR | 18,7 |
| ● OO | MT350OO | 17,6 |
| ● OS | MT350OS | 18,7 |

PACKAGING

L: 370 mm
D: 270 mm
H: 80 mm

3,9 kg

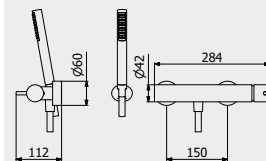

PORTATE | WATER FLOW | DÉBIT D'EAU

| | | |
|----------|----------|--------|
| 1 BAR | 2 BAR | 3 BAR |
| 12,5 l/m | 17,4 l/m | 21 l/m |

ARTICLE | ARTICOLO | ARTICLE

MT250



Wall mounted bath filler complete with hand shower kit

Bordo vasca esterno a parete completo di kit doccia

Mitigeur Bain/douche mural avec douchette encastrée

CODE / COEFFICIENT | CODICE /
COEFFICIENTE | CODE / COEFFICIENT

| | | |
|------|---------|------|
| ● CC | MT250CC | 13,1 |
| ● SS | MT250SS | 16,4 |
| ● ON | MT250ON | 13,1 |
| ● BO | MT250BO | 15,7 |
| ● NP | MT250NP | 15,7 |
| ● CF | MT250CF | 19,7 |
| ● CS | MT250CS | 21,0 |
| ● II | MT250II | 19,7 |
| ● IS | MT250IS | 21,0 |
| ● RS | MT250RS | 19,7 |
| ● SR | MT250SR | 21,0 |
| ● OO | MT250OO | 19,7 |
| ● OS | MT250OS | 21,0 |

PACKAGING

L: 370 mm
D: 270 mm
H: 80 mm

4,2 kg

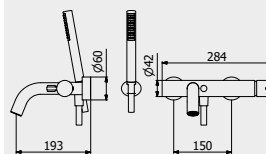

PORTATE | WATER FLOW | DÉBIT D'EAU

| | | |
|--------|----------|--------|
| 1 BAR | 2 BAR | 3 BAR |
| 10 l/m | 14,3 l/m | 18 l/m |

ARTICLE | ARTICOLO | ARTICLE

MT399



Free-standing bath filler with shower kit

Bordo vasca da terra con kit doccia

Bain douche complet alimentation au sol

CODE / COEFFICIENT | CODICE /
COEFFICIENTE | CODE / COEFFICIENT

| | | |
|------|----------|------|
| ● CC | EMT399CC | 28,0 |
| ● SS | EMT399SS | 35,0 |
| ● ON | EMT399ON | 28,0 |
| ● BO | EMT399BO | 33,6 |
| ● NP | EMT399NP | 33,6 |
| ● CF | EMT399CF | 42,0 |
| ● CS | EMT399CS | 44,8 |
| ● II | EMT399II | 42,0 |
| ● IS | EMT399IS | 44,8 |
| ● RS | EMT399RS | 42,0 |
| ● SR | EMT399SR | 44,8 |
| ● OO | EMT399OO | 42,0 |
| ● OS | EMT399OS | 44,8 |

PACKAGING

L: 1100 mm
D: 395 mm
H: 150 mm

15,6 kg

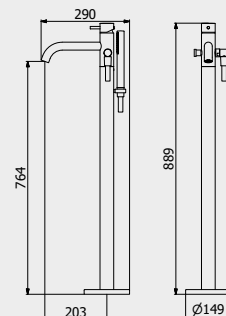

PORTATE | WATER FLOW | DÉBIT D'EAU

| | | |
|----------|--------|----------|
| 1 BAR | 2 BAR | 3 BAR |
| 11,2 l/m | 16 l/m | 19,5 l/m |

Built-in body to be purchased separately
AVAILABLE FROM JANUARY 2020Corpo incasso da acquistare separatamente
DISPONIBILE DA GENNAIO 2020Corps intégré à acheter séparément
DISPONIBLE À PARTIR DE JANVIER 2020

CODICE | CODE | CODE

INC399XXXN_19

COEFFICIENTE | COEFFICIENT | COEFFICIENT

2,8

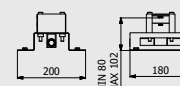

ARTICLE | ARTICOLO | ARTICLE

MT396



Four holes deck mounted bath filler with shower kit
Bordo vasca quattro fori con deviatore e kit doccia
Bain quatre trous avec inverseur et kit douche

| CODE / COEFFICIENT | CODICE / COEFFICIENTE | |
|--------------------|-----------------------|------|
| CC | MT396CC | 14,9 |
| SS | MT396SS | 18,6 |
| ON | MT396ON | 14,9 |
| BO | MT396BO | 17,9 |
| NP | MT396NP | 17,9 |
| CF | MT396CF | 22,4 |
| CS | MT396CS | 23,8 |
| II | MT396II | 22,4 |
| IS | MT396IS | 23,8 |
| RS | MT396RS | 22,4 |
| SR | MT396SR | 23,8 |
| OO | MT396OO | 22,4 |
| OS | MT396OS | 23,8 |

PACKAGING

L: 400 mm
D: 250 mm
H: 140 mm
4,0 kg

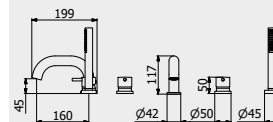

| PORTATE | WATER FLOW | DÉBIT D'EAU |
|---------|------------|-------------|
| 1 BAR | 2 BAR | 3 BAR |
| 9,3 l/m | 13,2 l/m | 16,2 l/m |

ARTICLE | ARTICOLO | ARTICLE

MT397



3 holes bath filler with overflow outlet connection, diverter and shower kit
Bordo vasca 3 fori per colonna riempimento con deviatore e kit doccia
Bain e 3 trous avec inverseur et kit douche pour remplissage ETP

| CODE / COEFFICIENT | CODICE / COEFFICIENTE | |
|--------------------|-----------------------|------|
| CC | MT397CC | 11,2 |
| SS | MT397SS | 14,0 |
| ON | MT397ON | 11,2 |
| BO | MT397BO | 13,4 |
| NP | MT397NP | 13,4 |
| CF | MT397CF | 16,8 |
| CS | MT397CS | 17,9 |
| II | MT397II | 16,8 |
| IS | MT397IS | 17,9 |
| RS | MT397RS | 16,8 |
| SR | MT397SR | 17,9 |
| OO | MT397OO | 16,8 |
| OS | MT397OS | 17,9 |

PACKAGING

L: 370 mm
D: 270 mm
H: 80 mm
3,2 kg

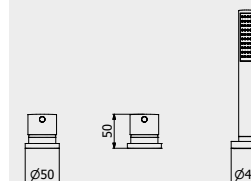

| PORTATE | WATER FLOW | DÉBIT D'EAU |
|---------|------------|-------------|
| 1 BAR | 2 BAR | 3 BAR |
| 12 l/m | 17 l/m | 22 l/m |

Milano
Torino

ARTICLE | ARTICOLO | ARTICLE

RU318



Built-in wall mounted waterfall spout
Cascata a parete con erogazione a lama esterna
Cascade murale avec bec externe

| CODE / COEFFICIENT | CODICE / COEFFICIENTE | |
|--------------------|-----------------------|------|
| CC | RU318CC | 22,9 |
| SS | RU318SS | 28,6 |
| BO | RU318BO | 27,5 |
| NP | RU318NP | 27,5 |
| CF | RU318CF | 34,4 |
| CS | RU318CS | 36,6 |
| II | RU318II | 34,4 |
| IS | RU318IS | 36,6 |
| RS | RU318RS | 34,4 |
| SR | RU318SR | 36,6 |
| OO | RU318OO | 34,4 |
| OS | RU318OS | 36,6 |

PACKAGING

L: 340 mm
D: 180 mm
H: 70 mm
4,0 kg

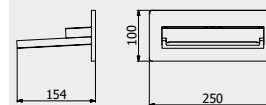

| PORTATE | WATER FLOW | DÉBIT D'EAU |
|---------|------------|-------------|
| 1 BAR | 2 BAR | 3 BAR |
| 13 l/m | 17 l/m | 20 l/m |

ARTICLE | ARTICOLO | ARTICLE

RU319



Wall mounted waterfall

Cascata a parete con erogazione diretta

Cascade murale

CODE / COEFFICIENT | CODICE /
COEFFICIENTE | CODE / COEFFICIENT

| | | |
|------|---------|------|
| ● CC | RU319CC | 12,8 |
| ● SS | RU319SS | 16,0 |
| ● BO | RU319BO | 15,4 |
| ● NP | RU319NP | 15,4 |
| ● CF | RU319CF | 19,2 |
| ● CS | RU319CS | 20,5 |
| ● II | RU319II | 19,2 |
| ● IS | RU319IS | 20,5 |
| ● RS | RU319RS | 19,2 |
| ● SR | RU319SR | 20,5 |
| ● OO | RU319OO | 19,2 |
| ● OS | RU319OS | 20,5 |

PACKAGING

 L: 340 mm
D: 180 mm
H: 70 mm

3,1 kg

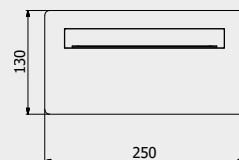

PORTATE | WATER FLOW | DÉBIT D'EAU

| | | |
|--------|--------|--------|
| 1 BAR | 2 BAR | 3 BAR |
| 13 l/m | 17 l/m | 20 l/m |

ARTICLE | ARTICOLO | ARTICLE

MT320



Wall mounted spout

Bocca d'erogazione a parete

Bec de remplissage mural

CODE / COEFFICIENT | CODICE /
COEFFICIENTE | CODE / COEFFICIENT

| | | |
|------|---------|-----|
| ● CC | MT320CC | 2,1 |
| ● SS | MT320SS | 2,6 |
| ● ON | MT320ON | 2,1 |
| ● BO | MT320BO | 2,5 |
| ● NP | MT320NP | 2,5 |
| ● CF | MT320CF | 3,2 |
| ● CS | MT320CS | 3,4 |
| ● II | MT320II | 3,2 |
| ● IS | MT320IS | 3,4 |
| ● RS | MT320RS | 3,2 |
| ● SR | MT320SR | 3,4 |
| ● OO | MT320OO | 3,2 |
| ● OS | MT320OS | 3,4 |

PACKAGING

 L: 150 mm
D: 190 mm
H: 98 mm

0,2 kg

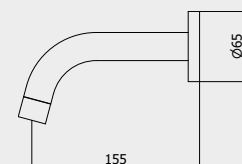

PORTATE | WATER FLOW | DÉBIT D'EAU

| | | |
|--------|--------|--------|
| 1 BAR | 2 BAR | 3 BAR |
| 10 l/m | 14 l/m | 17 l/m |

ARTICLE | ARTICOLO | ARTICLE

MT321



Short wall mounted spout

Bocca d'erogazione corta a parete

Bec de remplissage mural court

CODE / COEFFICIENT | CODICE /
COEFFICIENTE | CODE / COEFFICIENT

| | | |
|------|---------|-----|
| ● CC | MT321CC | 2,5 |
| ● SS | MT321SS | 3,1 |
| ● ON | MT321ON | 2,5 |
| ● BO | MT321BO | 3,0 |
| ● NP | MT321NP | 3,0 |
| ● CF | MT321CF | 3,8 |
| ● CS | MT321CS | 4,0 |
| ● II | MT321II | 3,8 |
| ● IS | MT321IS | 4,0 |
| ● RS | MT321RS | 3,8 |
| ● SR | MT321SR | 4,0 |
| ● OO | MT321OO | 3,8 |
| ● OS | MT321OS | 4,0 |

PACKAGING

 L: 150 mm
D: 190 mm
H: 98 mm

0,2 kg

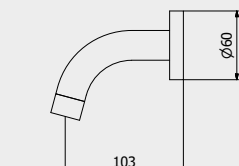

PORTATE | WATER FLOW | DÉBIT D'EAU

| | | |
|--------|--------|--------|
| 1 BAR | 2 BAR | 3 BAR |
| 10 l/m | 14 l/m | 17 l/m |

ARTICLE | ARTICOLO | ARTICLE

MT322



Long wall mounted spout

Bocca d'erogazione lunga a parete

Bec de remplissage mural long

CODE / COEFFICIENT | CODICE /
COEFFICIENTE | CODE / COEFFICIENT

| | | |
|------|---------|-----|
| ● CC | MT322CC | 2,5 |
| ● SS | MT322SS | 3,1 |
| ● ON | MT322ON | 2,5 |
| ● BO | MT322BO | 3,0 |
| ● NP | MT322NP | 3,0 |
| ● CF | MT322CF | 3,8 |
| ● CS | MT322CS | 4,0 |
| ● II | MT322II | 3,8 |
| ● IS | MT322IS | 4,0 |
| ● RS | MT322RS | 3,8 |
| ● SR | MT322SR | 4,0 |
| ● OO | MT322OO | 3,8 |
| ● OS | MT322OS | 4,0 |

PACKAGING

 L: 150 mm
D: 190 mm
H: 98 mm

0,2 kg

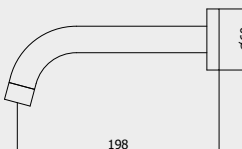

PORTATE | WATER FLOW | DÉBIT D'EAU

| | | |
|--------|--------|--------|
| 1 BAR | 2 BAR | 3 BAR |
| 10 l/m | 14 l/m | 17 l/m |



ARTICLE | ARTICOLO | ARTICLE

MT801



Milano Torino thermostatic shower column with shower kit
Colonna doccia Milano Torino termostatica con kit doccia
Milano Torino colonne de douche thermostatique avec kit douche

| CODE / COEFFICIENT | CODICE / COEFFICIENTE | COEFFICIENT |
|--------------------|-----------------------|-------------|
| CC | MT801CC | 25,1 |
| SS | MT801SS | 31,4 |
| BO | MT801BO | 30,1 |
| NP | MT801NP | 30,1 |

PACKAGING

L: 1020 mm
D: 490 mm
H: 120 mm
3,4 kg

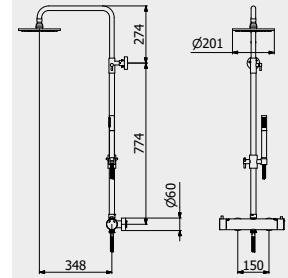

PORTATE | WATER FLOW | DÉBIT D'EAU

| 1 BAR | 2 BAR | 3 BAR |
|----------|--------|----------|
| 11,2 l/m | 17 l/m | 21,2 l/m |

ARTICLE | ARTICOLO | ARTICLE

MT706



Exposed parts for bidet spray complete with mixer
Set di parti esterne per Idroscopino igienico con miscelatore
Partie extérieure pour douchette hygiénique avec mitigeur

| CODE / COEFFICIENT | CODICE / COEFFICIENTE | COEFFICIENT |
|--------------------|-----------------------|-------------|
| CC | EMT706CC | 9,8 |
| SS | EMT706SS | 12,3 |
| ON | EMT706ON | 9,8 |
| BO | EMT706BO | 11,8 |
| NP | EMT706NP | 11,8 |
| CF | EMT706CF | 14,7 |
| CS | EMT706CS | 15,7 |
| II | EMT706II | 14,7 |
| IS | EMT706IS | 15,7 |
| RS | EMT706RS | 14,7 |
| SR | EMT706SR | 15,7 |
| OO | EMT706OO | 14,7 |
| OS | EMT706OS | 15,7 |

PACKAGING

L: 370 mm
D: 270 mm
H: 80 mm
3,1 kg

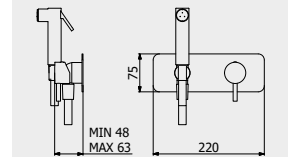

PORTATE | WATER FLOW | DÉBIT D'EAU

| 1 BAR | 2 BAR | 3 BAR |
|---------|---------|----------|
| 2,3 l/m | 3,2 l/m | 12,5 l/m |

Milano Torino

Built-in body to be purchased separately

Corpo incasso da acquistare separatamente

Corps intégré à acheter séparément



CODICE | CODE | CODE
INC206XXXN_19

COEFFICIENTE | COEFFICIENT | COEFFICIENT
2,9



ARTICLE | ARTICOLO | ARTICLE

MT370



Single Lever kitchen mixer
Miscelatore lavello monoforo
Évier de cuisine

| CODE / COEFFICIENT | CODICE / COEFFICIENTE | COEFFICIENT |
|--------------------|-----------------------|-------------|
| CC | MT370CC | 9,6 |
| SS | MT370SS | 12,0 |
| ON | MT370ON | 9,6 |
| BO | MT370BO | 11,5 |
| NP | MT370NP | 11,5 |
| CF | MT370CF | 14,4 |
| CS | MT370CS | 15,4 |
| II | MT370II | 14,4 |
| IS | MT370IS | 15,4 |
| RS | MT370RS | 14,4 |
| SR | MT370SR | 15,4 |
| OO | MT370OO | 14,4 |
| OS | MT370OS | 15,4 |

PACKAGING

L: 455 mm
D: 310 mm
H: 75 mm
2,6 kg

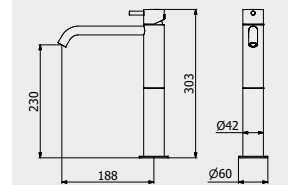

PORTATE | WATER FLOW | DÉBIT D'EAU

| 1 BAR | 2 BAR | 3 BAR |
|---------|--------|----------|
| 6,3 l/m | 89 l/m | 10,9 l/m |

MODERNA / ACCESSORIES COLLECTION

ARTICLE | ARTICOLO | ARTICLE

MO001

Wall soap-holder

Porta sapone a muro

Porte distributeur de savon encastré

CODE / COEFFICIENT | CODICE /
COEFFICIENTE | CODE / COEFFICIENT

CC MO001CC 1,5

PACKAGING

L: 110 mm
 D: 130 mm
 H: 50 mm
 0,4 kg

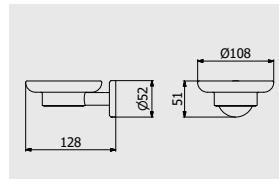

ARTICLE | ARTICOLO | ARTICLE

MO003

Wall toothbrush holder

Bicchieri porta spazzolino a parete

Porte-verre en verre gravé

CODE / COEFFICIENT | CODICE /
COEFFICIENTE | CODE / COEFFICIENT

CC MO003CC 1,5

PACKAGING

L: 70 mm
 D: 110 mm
 H: 100 mm
 0,4 kg

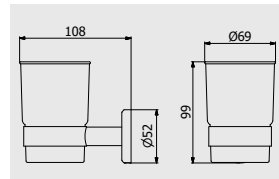

ARTICLE | ARTICOLO | ARTICLE

MO014

Towel holder

Porta salvietta

Porte-serviette

CODE / COEFFICIENT | CODICE /
COEFFICIENTE | CODE / COEFFICIENT

CC MO014CC 2,2

PACKAGING

L: 500 mm
 D: 70 mm
 H: 50 mm
 0,5 kg

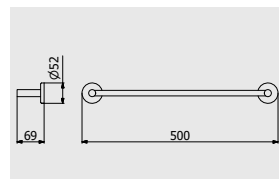

ARTICLE | ARTICOLO | ARTICLE

MO002

Wall soap dispenser holder

Porta dispenser sapone liquido a parete

Porte distributeur de savon en verre gravé

CODE / COEFFICIENT | CODICE /
COEFFICIENTE | CODE / COEFFICIENT

CC MO002CC 2,3

PACKAGING

L: 80 mm
 D: 130 mm
 H: 180 mm
 0,1 kg

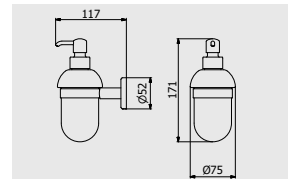

ARTICLE | ARTICOLO | ARTICLE

MO004

Towel holder

Porta salvietta

Porte-serviette

CODE / COEFFICIENT | CODICE /
COEFFICIENTE | CODE / COEFFICIENT

CC MO004CC 2,4

PACKAGING

L: 650 mm
 D: 70 mm
 H: 50 mm
 0,5 kg

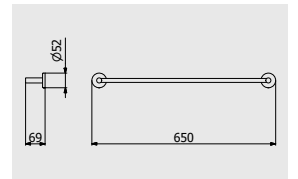

ARTICLE | ARTICOLO | ARTICLE

MO006

Towel holder

Porta salvietta

Porte-serviette

CODE / COEFFICIENT | CODICE /
COEFFICIENTE | CODE / COEFFICIENT

CC MO006CC 2,1

PACKAGING

L: 350 mm
 D: 70 mm
 H: 50 mm
 0,4 kg

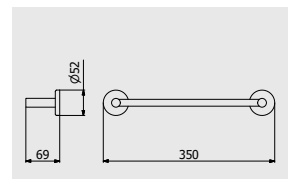

ARTICLE | ARTICOLO | ARTICLE

MO007

Ring Towel holder

Porta salvietta ad anello

Porte-serviettes anneau

CODE / COEFFICIENT | CODICE /
COEFFICIENTE | CODE / COEFFICIENT

CC MO007CC 1,6

PACKAGING

L: 180 mm
D: 70 mm
H: 200 mm

0,8 kg

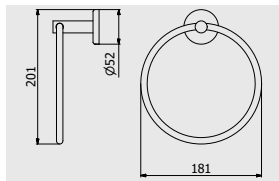

ARTICLE | ARTICOLO | ARTICLE

MO008

Robe Hook

Appendino a parete

Cintre

CODE / COEFFICIENT | CODICE /
COEFFICIENTE | CODE / COEFFICIENT

CC MO008CC 0,9

PACKAGING

L: 50 mm
D: 50 mm
H: 50 mm

0,3 kg

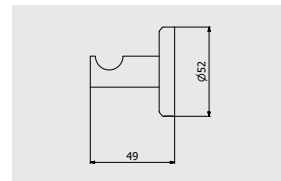

ARTICLE | ARTICOLO | ARTICLE

MO009

Double robe hook

Doppio appendino a parete

Double cintre

CODE / COEFFICIENT | CODICE /
COEFFICIENTE | CODE / COEFFICIENT

CC MO009CC 1,4

PACKAGING

L: 70 mm
D: 70 mm
H: 50 mm

0,1 kg

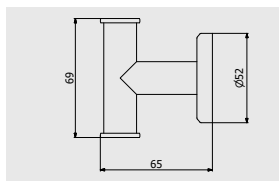

ARTICLE | ARTICOLO | ARTICLE

MO010

Shelf

Mensola

Etagère

CODE / COEFFICIENT | CODICE /
COEFFICIENTE | CODE / COEFFICIENT

CC MO010CC 3,0

PACKAGING

L: 600 mm
D: 140 mm
H: 50 mm

0,3 kg

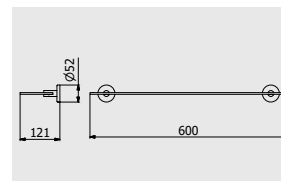

ARTICLE | ARTICOLO | ARTICLE

MO005

Swiveable towel holder

Porta salvietta doppio

Porte-serviettes noeud

CODE / COEFFICIENT | CODICE /
COEFFICIENTE | CODE / COEFFICIENT

CC MO005CC 3,5

PACKAGING

L: 430 mm
D: 70 mm
H: 50 mm

0,5 kg

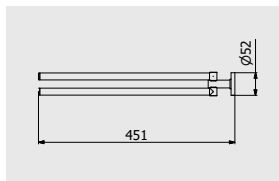

ARTICLE | ARTICOLO | ARTICLE

MO011

Toilet paper holder

Porta rotolo

Porte rouleaux de toilette

CODE / COEFFICIENT | CODICE /
COEFFICIENTE | CODE / COEFFICIENT

CC MO011CC 1,4

PACKAGING

L: 150 mm
D: 70 mm
H: 50 mm

0,2 kg

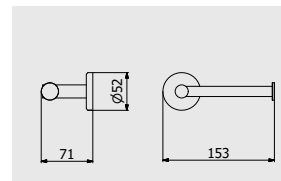

ARTICLE | ARTICOLO | ARTICLE

MO012

Toilet brush holder

Porta scopino da terra

Porte balayette au sol

CODE / COEFFICIENT | CODICE /
COEFFICIENTE | CODE / COEFFICIENT

CC MO012CC 2,5

PACKAGING

L: 80 mm
D: 80 mm
H: 380 mm

0,7 kg

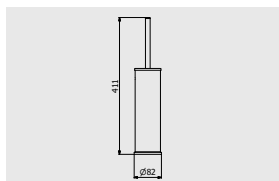

ARTICLE | ARTICOLO | ARTICLE

MO013

Wall toilet brush holder

Porta scopino da parete

Porte balayette

CODE / COEFFICIENT | CODICE /
COEFFICIENTE | CODE / COEFFICIENT

CC MO013CC 2,9

PACKAGING

L: 80 mm
D: 80 mm
H: 380 mm

0,7 kg

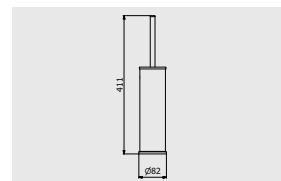

BATLÒ

The reference is the archetype, the shape of the bottle.

Il riferimento è l'archetipo, la forma della bottiglia.

Le point de repère est l'archétype, la forme d'une bouteille.

The collection is inspired by the traditional form of the most iconic and sinuous liquid container, a bottle of water. The lever control, corresponding to the narrow neck of the bottle, allows a soft and vertical closing and opening of the water flow. The fluidity and the intuitive identity of the form is applied to the entire collection, which ranges from the ceiling washbasin mixer to the free-standing bath filler.

La serie è ispirata alla tradizionale forma di una bottiglia d'acqua, contenitore di liquidi sinuoso e iconico. Il comando di erogazione, corrispondente al restringimento del collo della bottiglia, permette un movimento di chiusura e apertura del flusso d'acqua morbido e verticale. La fluidità e l'intuitiva riconoscibilità della forma si estendono alla ricca collezione, che spazia dal lavabo mixer e a soffitto, fino al bordo vasca free-standing.

La collection s'inspire de la forme traditionnelle d'une bouteille d'eau, récipient de liquide sinuose et emblématique. La poignée de commande, correspondant au resserrement du col de la bouteille, permet un mouvement de fermeture et d'ouverture de l'eau doux et vertical. La fluidité et la notoriété intuitive de la forme concernent à l'entière riche collection, qui va du lavabo mixer à plafond jusqu'au bord free-standing de la baignoire.



KITCHEN
AVAILABLE



CRYSTAL CLEAR
WATER



LEAD FREE



ZINC FREE





Batlo

DESIGN
GIULIO IACCHETTI

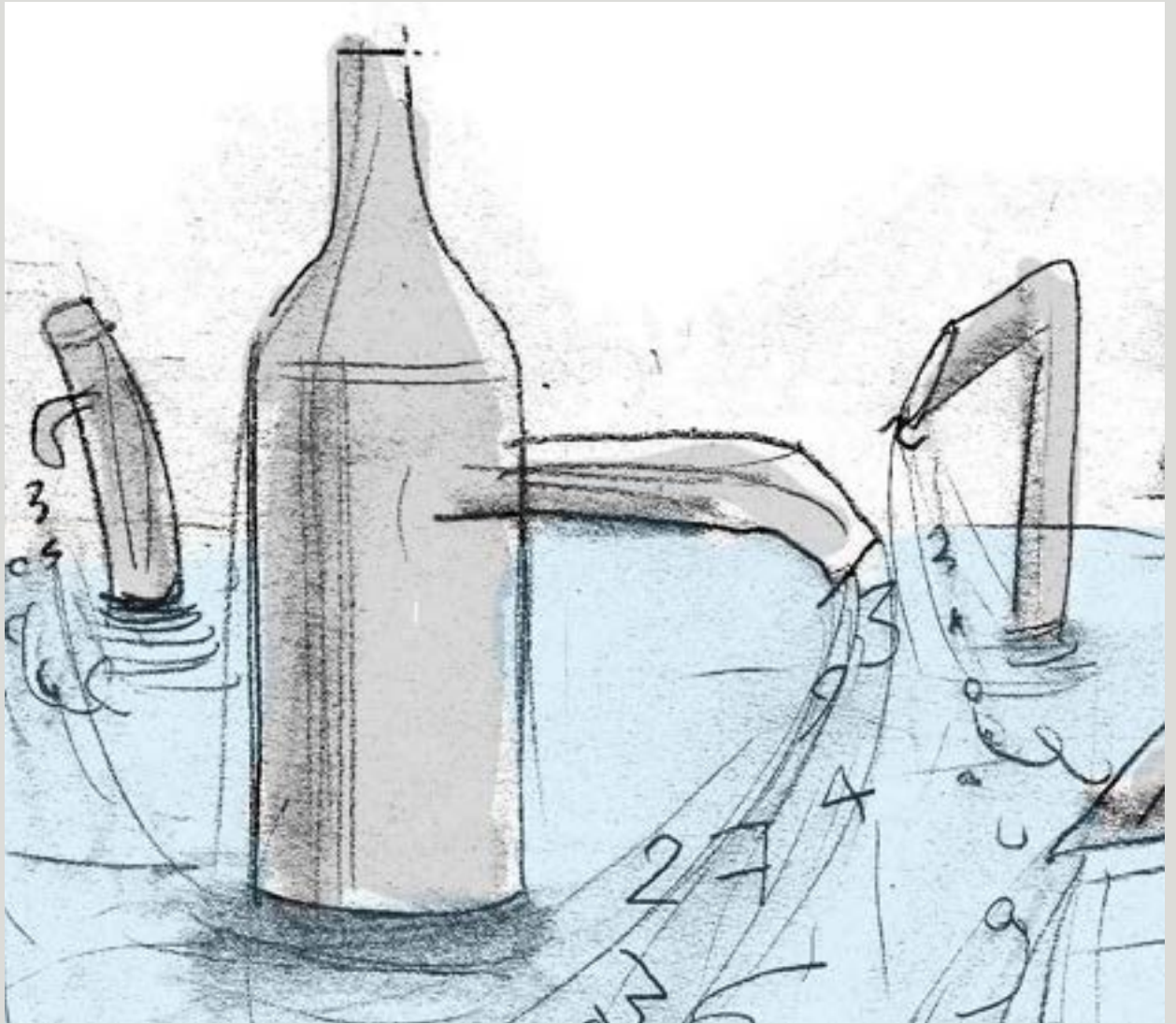

I like the idea that, only by watching the objects I designed, it's easy to connect them to the function they are appointed to perform.

Mi piace l'idea che guardando gli oggetti che disegno sia semplice ricondurli alla funzione che sono chiamati a compiere.

J'aime l'idée qu'il soit facile, juste en regardant les objets que j'ai conçus, de les ramener à la fonction qu'ils sont appelés à exécuter.

“ **Having to design a new faucet, I was inspired by the form of a bottle, the container for liquids par excellence ... for the handles I designed some inverted goblets and the shower is an umbrella handle!... It's still water, isn't it?!**

Dovendo progettare un nuovo rubinetto ho pensato alla bottiglia, contenitore per eccellenza di liquidi... per le manopole ho disegnato dei calici rovesciati e la doccia è il manico di un ombrello!... sempre di acqua si tratta no?!

Devant concevoir un nouveau robinet, j'ai pensé à une bouteille, le récipient de liquides par excellence... pour ce qui concerne les manettes, j'ai conçu des verres renversés et la douche est le manche d'un parapluie!... il s'agit quand même d'eau, n'est-ce pas?!

”

Giulio Iacchetti design for BATLÓ

Batló



↑ BI200CC
Monohole washbasin mixer
Miscelatore lavabo monoforo
Mitigeur lavabo

→ BI202CC
Tall monohole washbasin mixer
Miscelatore lavabo monoforo alto
Mitigeur lavabo haut



Batlo





Batlo

← BI200CC
Monohole washbasin mixer
Miscelatore lavabo monoforo
Mitigeur lavabo

↗ BI220CC
Monohole bidet mixer
Miscelatore bidet monoforo
Mitigeur bidet



↑ BI206CC
Wall mounted washbasin mixer
Miscelatore lavabo due fori a parete
Mitigeur lavabo mural

→ BI392CC
Three holes washbasin set with low spout
Lavabo tre fori a bocca bassa
Lavabo trois trous bec bas



Batlo



↖ **BI300CC**
One way wall shower mixer
Miscelatore doccia a parete una via
Mitigeur douche mural une voie

→ **BI250CC**
Wall mounted bath filler complete with hand shower kit
Bordo vasca esterno a parete completo di kit doccia
Mitigeur Bain/douche Mural avec douchette encastrée





Batlo

ARTICLE | ARTICOLO | ARTICLE

BI200



Monohole washbasin mixer complete with drain

Miscelatore lavabo monoforo completo di scarico automatico

Mitigeur Lavabo complet avec bonde automatique

CODE / COEFFICIENT | CODICE /
COEFFICIENTE | CODE / COEFFICIENT

| | | |
|------|---------|------|
| ● CC | BI200CC | 7,5 |
| ● SS | BI200SS | 9,4 |
| ● BO | BI200BO | 9,0 |
| ● NP | BI200NP | 9,0 |
| ● CF | BI200CF | 11,3 |
| ● CS | BI200CS | 12,0 |
| ● II | BI200II | 11,3 |
| ● IS | BI200IS | 12,0 |
| ● RS | BI200RS | 11,3 |
| ● SR | BI200SR | 12,0 |
| ● OO | BI200OO | 11,3 |
| ● OS | BI200OS | 12,0 |

PACKAGING

 L: 340 mm
 D: 180 mm
 H: 70 mm

 1,9 kg

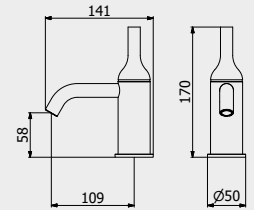

PORTATE | WATER FLOW | DÉBIT D'EAU

| | | |
|---------|-------|--------|
| 1 BAR | 2 BAR | 3 BAR |
| 6,3 l/m | 9 l/m | 11 l/m |

ARTICLE | ARTICOLO | ARTICLE

BI204



Mid-size monohole washbasin mixer complete with drain

Miscelatore lavabo monoforo medio completo di scarico automatico

Mitigeur Lavabo Moyen complet avec bonde automatique

CODE / COEFFICIENT | CODICE /
COEFFICIENTE | CODE / COEFFICIENT

| | | |
|------|---------|------|
| ● CC | BI204CC | 7,7 |
| ● SS | BI204SS | 9,6 |
| ● BO | BI204BO | 9,2 |
| ● NP | BI204NP | 9,2 |
| ● CF | BI204CF | 11,6 |
| ● CS | BI204CS | 12,3 |
| ● II | BI204II | 11,6 |
| ● IS | BI204IS | 12,3 |
| ● RS | BI204RS | 11,6 |
| ● SR | BI204SR | 12,3 |
| ● OO | BI204OO | 11,6 |
| ● OS | BI204OS | 12,3 |

PACKAGING

 L: 340 mm
 D: 180 mm
 H: 70 mm

 1,7 kg

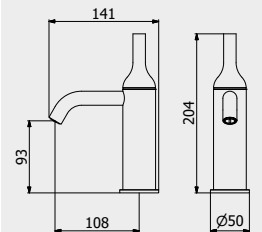

PORTATE | WATER FLOW | DÉBIT D'EAU

| | | |
|---------|-------|--------|
| 1 BAR | 2 BAR | 3 BAR |
| 6,3 l/m | 9 l/m | 11 l/m |

ARTICLE | ARTICOLO | ARTICLE

BI202



Tall monohole washbasin mixer complete with drain

Miscelatore lavabo monoforo alto completo di scarico automatico

Mitigeur lavabo Haut complet avec bonde automatique

CODE / COEFFICIENT | CODICE /
COEFFICIENTE | CODE / COEFFICIENT

| | | |
|------|---------|------|
| ● CC | BI202CC | 10,4 |
| ● SS | BI202SS | 13,0 |
| ● BO | BI202BO | 12,5 |
| ● NP | BI202NP | 12,5 |
| ● CF | BI202CF | 15,6 |
| ● CS | BI202CS | 16,6 |
| ● II | BI202II | 15,6 |
| ● IS | BI202IS | 16,6 |
| ● RS | BI202RS | 15,6 |
| ● SR | BI202SR | 16,6 |
| ● OO | BI202OO | 15,6 |
| ● OS | BI202OS | 16,6 |

PACKAGING

 L: 425 mm
 D: 188 mm
 H: 98 mm

 2,8 kg

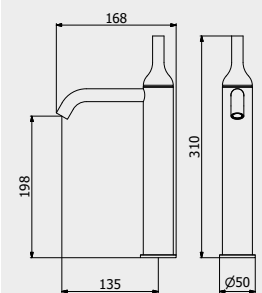

PORTATE | WATER FLOW | DÉBIT D'EAU

| | | |
|---------|-------|--------|
| 1 BAR | 2 BAR | 3 BAR |
| 6,3 l/m | 9 l/m | 11 l/m |



ARTICLE | ARTICOLO | ARTICLE

BI206



Wall mounted washbasin mixer complete with drain
Miscelatore lavabo due fori a parete completo di scarico automatico
Mitigeur lavabo mural complet avec bonde automatique

| CODE / COEFFICIENT CODICE / COEFFICIENTE CODE / COEFFICIENT | |
|---|---------------|
| CC | EBI206CC 8,8 |
| SS | EBI206SS 11,0 |
| BO | EBI206BO 10,6 |
| NP | EBI206NP 10,6 |
| CF | EBI206CF 13,2 |
| CS | EBI206CS 14,1 |
| II | EBI206II 13,2 |
| IS | EBI206IS 14,1 |
| RS | EBI206RS 13,2 |
| SR | EBI206SR 14,1 |
| OO | EBI206OO 13,2 |
| OS | EBI206OS 14,1 |

PACKAGING

L: 265 mm
D: 260 mm
H: 70 mm
1,2 kg

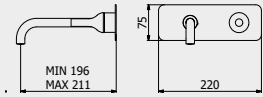

PORTATE | WATER FLOW | DÉBIT D'EAU

| | | |
|---------|----------|--------|
| 1 BAR | 2 BAR | 3 BAR |
| 7,6 l/m | 10,5 l/m | 13 l/m |

Built-in body to be purchased separately
Corpo incasso da acquistare separatamente
Corps intégré à acheter séparément



CODICE | CODE | CODE

INC206XXXN_19

COEFFICIENTE | COEFFICIENT | COEFFICIENT
2,9



ARTICLE | ARTICOLO | ARTICLE

BI207



Wall mounted washbasin mixer with long spout complete with drain
Miscelatore lavabo 2 fori a parete con bocca lunga completo di scarico
Mitigeur lavabo mural bec long complet avec bonde automatique

| CODE / COEFFICIENT CODICE / COEFFICIENTE CODE / COEFFICIENT | |
|---|---------------|
| CC | EBI207CC 9,6 |
| SS | EBI207SS 12,0 |
| ON | EBI207ON 9,6 |
| BO | EBI207BO 11,5 |
| NP | EBI207NP 11,5 |
| CF | EBI207CF 14,4 |
| CS | EBI207CS 15,4 |
| II | EBI207II 14,4 |
| IS | EBI207IS 15,4 |
| RS | EBI207RS 14,4 |
| SR | EBI207SR 15,4 |
| OO | EBI207OO 14,4 |
| OS | EBI207OS 15,4 |

PACKAGING

L: 265 mm
D: 260 mm
H: 70 mm
1,2 kg

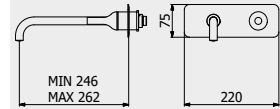

PORTATE | WATER FLOW | DÉBIT D'EAU

| | | |
|---------|----------|--------|
| 1 BAR | 2 BAR | 3 BAR |
| 7,6 l/m | 10,5 l/m | 13 l/m |

Built-in body to be purchased separately
Corpo incasso da acquistare separatamente
Corps intégré à acheter séparément



CODICE | CODE | CODE

INC206XXXN_19

COEFFICIENTE | COEFFICIENT | COEFFICIENT
2,9



ARTICLE | ARTICOLO | ARTICLE

BI208



Wall mounted washbasin mixer with short spout complete with drain
Miscelatore lavabo 2 fori a parete con bocca corta completo di scarico
Mitigeur lavabo mural bec court complet avec bonde automatique

| CODE / COEFFICIENT CODICE / COEFFICIENTE CODE / COEFFICIENT | |
|---|---------------|
| CC | EBI208CC 9,6 |
| SS | EBI208SS 12,0 |
| ON | EBI208ON 9,6 |
| BO | EBI208BO 11,5 |
| NP | EBI208NP 11,5 |
| CF | EBI208CF 14,4 |
| CS | EBI208CS 15,4 |
| II | EBI208II 14,4 |
| IS | EBI208IS 15,4 |
| RS | EBI208RS 14,4 |
| SR | EBI208SR 15,4 |
| OO | EBI208OO 14,4 |
| OS | EBI208OS 15,4 |

PACKAGING

L: 265 mm
D: 260 mm
H: 70 mm
1,2 kg

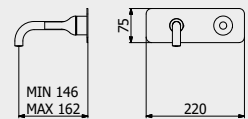

PORTATE | WATER FLOW | DÉBIT D'EAU

| | | |
|---------|----------|--------|
| 1 BAR | 2 BAR | 3 BAR |
| 7,6 l/m | 10,5 l/m | 13 l/m |

Built-in body to be purchased separately
Corpo incasso da acquistare separatamente
Corps intégré à acheter séparément



CODICE | CODE | CODE

INC206XXXN_19

COEFFICIENTE | COEFFICIENT | COEFFICIENT
2,9

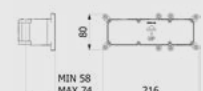

ARTICLE | ARTICOLO | ARTICLE

BI210



Ceiling spout with wall mounted mixer

Bocca da soffitto con comando remoto ad incasso

Mitigeur lavabo mural avec bec plafond complet avec bonde automatique

| CODE / COEFFICIENT | CODICE / COEFFICIENTE | CODE / COEFFICIENT |
|--------------------|-----------------------|--------------------|
| ● CC | EBI210CC | 27,5 |
| ● SS | EBI210SS | 34,4 |
| ● BO | EBI210BO | 33,0 |
| ● NP | EBI210NP | 33,0 |

PACKAGING

● L: 150 mm
D: 190 mm
H: 98 mm

● L: 1700 mm
Ø: 70 mm

● 4,5 kg

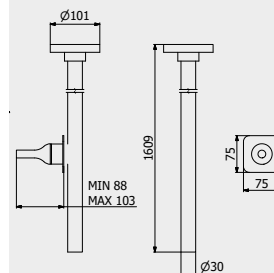

PORTATE | WATER FLOW | DÉBIT D'EAU

| 1 BAR | 2 BAR | 3 BAR |
|---------|---------|-------|
| 4,3 l/m | 5,2 l/m | 7 l/m |

Built-in body to be purchased separately

Corpo incasso da acquistare separatamente

Corps intégré à acheter séparément



CODICE | CODE | CODE

INC300XXXN_19

COEFFICIENTE | COEFFICIENT | COEFFICIENT

1,8



ARTICLE | ARTICOLO | ARTICLE

BI299



Monohole free-standing washbasin mixer complete with drain

Miscelatore lavabo da terra completo di scarico automatico

Mitigeur lavabo free standing complet avec bonde automatique

| CODE / COEFFICIENT | CODICE / COEFFICIENTE | CODE / COEFFICIENT |
|--------------------|-----------------------|--------------------|
| ● CC | EBI299CC | 29,7 |
| ● SS | EBI299SS | 37,1 |
| ● BO | EBI299BO | 35,6 |
| ● NP | EBI299NP | 35,6 |
| ● CF | EBI299CF | 44,6 |
| ● CS | EBI299CS | 47,5 |
| ● II | EBI299II | 44,6 |
| ● IS | EBI299IS | 47,5 |
| ● RS | EBI299RS | 44,6 |
| ● SR | EBI299SR | 47,5 |
| ● OO | EBI299OO | 44,6 |
| ● OS | EBI299OS | 47,5 |

PACKAGING

● L: 1160 mm
D: 360 mm
H: 180 mm

● 13,8 kg

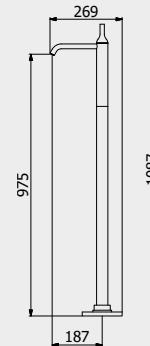

PORTATE | WATER FLOW | DÉBIT D'EAU

| 1 BAR | 2 BAR | 3 BAR |
|--------|--------|--------|
| 13 l/m | 16 l/m | 19 l/m |

Built-in body to be purchased separately
AVAILABLE FROM JANUARY 2020

Corpo incasso da acquistare separatamente
DISPONIBILE DA GENNAIO 2020

Corps intégré à acheter séparément
DISPONIBLE À PARTIR DE JANVIER 2020



CODICE | CODE | CODE

INC399XXXN_19

COEFFICIENTE | COEFFICIENT | COEFFICIENT

2,8

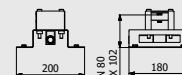

ARTICLE | ARTICOLO | ARTICLE

BI392



Three holes washbasin set with low spout

Lavabo tre fori a bocca bassa completo di scarico automatico

Lavabo trois trous bec bas

| CODE / COEFFICIENT | CODICE / COEFFICIENTE | CODE / COEFFICIENT |
|--------------------|-----------------------|--------------------|
| ● CC | BI392CC | 12,1 |
| ● SS | BI392SS | 15,1 |
| ● BO | BI392BO | 14,5 |
| ● NP | BI392NP | 14,5 |
| ● CF | BI392CF | 18,2 |
| ● CS | BI392CS | 19,4 |
| ● II | BI392II | 18,2 |
| ● IS | BI392IS | 19,4 |
| ● RS | BI392RS | 18,2 |
| ● SR | BI392SR | 19,4 |
| ● OO | BI392OO | 18,2 |
| ● OS | BI392OS | 19,4 |

PACKAGING

● L: 370 mm
D: 270 mm
H: 80 mm

● 3 kg

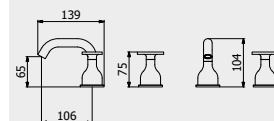

PORTATE | WATER FLOW | DÉBIT D'EAU

| 1 BAR | 2 BAR | 3 BAR |
|---------|---------|--------|
| 6,3 l/m | 8,9 l/m | 11 l/m |



ARTICLE | ARTICOLO | ARTICLE

BI220



Monohole bidet mixer complete with drain

Miscelatore bidet monoforo completo di scarico automatico

Mitigeur bidet complet avec bonde automatique

| CODE / COEFFICIENT | CODICE / COEFFICIENTE | COEFFICIENT |
|--------------------|-----------------------|-------------|
| CC | BI220CC | 7,5 |
| SS | BI220SS | 9,4 |
| BO | BI220BO | 9,0 |
| NP | BI220NP | 9,0 |
| CF | BI220CF | 11,3 |
| CS | BI220CS | 12,0 |
| II | BI220II | 11,3 |
| IS | BI220IS | 12,0 |
| RS | BI220RS | 11,3 |
| SR | BI220SR | 12,0 |
| OO | BI220OO | 11,3 |
| OS | BI220OS | 12,0 |

PACKAGING

L: 340 mm
D: 180 mm
H: 70 mm

1,7 kg

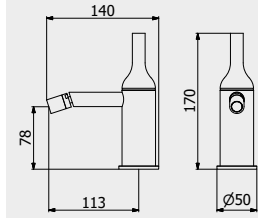

PORTATE | WATER FLOW | DÉBIT D'EAU

| 1 BAR | 2 BAR | 3 BAR |
|---------|---------|--------|
| 6,3 l/m | 8,5 l/m | 11 l/m |

ARTICLE | ARTICOLO | ARTICLE

BI300



Exposed parts for manual wall mixer

Set di parti esterne per miscelatore a parete ad una via

Partie extérieure pour mitigeur encastré à une voie

| CODE / COEFFICIENT | CODICE / COEFFICIENTE | COEFFICIENT |
|--------------------|-----------------------|-------------|
| CC | EBI300CC | 4,1 |
| SS | EBI300SS | 5,1 |
| BO | EBI300BO | 4,9 |
| NP | EBI300NP | 4,9 |
| CF | EBI300CF | 6,2 |
| CS | EBI300CS | 6,6 |
| II | EBI300II | 6,2 |
| IS | EBI300IS | 6,6 |
| RS | EBI300RS | 6,2 |
| SR | EBI300SR | 6,6 |
| OO | EBI300OO | 6,2 |
| OS | EBI300OS | 6,6 |

PACKAGING

L: 150 mm
D: 190 mm
H: 98 mm

1,2 kg

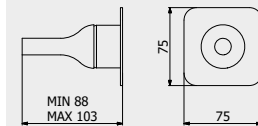

PORTATE | WATER FLOW | DÉBIT D'EAU

| 1 BAR | 2 BAR | 3 BAR |
|----------|--------|----------|
| 13,5 l/m | 19 l/m | 23,3 l/m |

Batìò

Built-in body to be purchased separately

Corpo incasso da acquistare separatamente

Corps intégré à acheter séparément



CODICE | CODE | CODE
INC300XXN_19

COEFFICIENTE | COEFFICIENT | COEFFICIENT

1,8

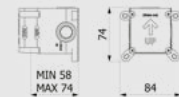

ARTICLE | ARTICOLO | ARTICLE

BI310



Exposed parts for manual wall mixer with two ways diverter

Miscelatore doccia a parete con deviatore due vie

Mitigeur douche mural deux voies avec inverseur

| CODE / COEFFICIENT | CODICE / COEFFICIENTE | COEFFICIENT |
|--------------------|-----------------------|-------------|
| CC | EBI310CC | 7,3 |
| SS | EBI310SS | 9,1 |
| ON | EBI310ON | 7,3 |
| BO | EBI310BO | 8,8 |
| NP | EBI310NP | 8,8 |
| CF | EBI310CF | 11,0 |
| CS | EBI310CS | 11,7 |
| II | EBI310II | 11,0 |
| IS | EBI310IS | 11,7 |
| RS | EBI310RS | 11,0 |
| SR | EBI310SR | 11,7 |
| OO | EBI310OO | 11,0 |
| OS | EBI310OS | 11,7 |

PACKAGING

L: 150 mm
D: 190 mm
H: 98 mm

1,2 kg

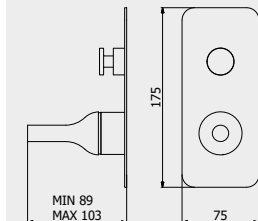

PORTATE | WATER FLOW | DÉBIT D'EAU

| 1 BAR | 2 BAR | 3 BAR |
|----------|--------|----------|
| 13,5 l/m | 19 l/m | 23,3 l/m |

Built-in body to be purchased separately

Corpo incasso da acquistare separatamente

Corps intégré à acheter séparément



CODICE | CODE | CODE
INC310XXN_19

COEFFICIENTE | COEFFICIENT | COEFFICIENT

3,3

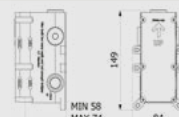

ARTICLE | ARTICOLO | ARTICLE

BI312



Exposed parts for manual wall mixer with three ways diverter
Set di parti esterne per miscelatore a parete a tre vie
Mitigeur douche mural trois voies avec inverseur

| CODE / COEFFICIENT | CODICE / COEFFICIENTE | CODE / COEFFICIENT |
|--------------------|-----------------------|--------------------|
| CC | EBI312CC | 7,8 |
| SS | EBI312SS | 9,8 |
| BO | EBI312BO | 9,4 |
| NP | EBI312NP | 9,4 |
| CF | EBI312CF | 11,7 |
| CS | EBI312CS | 12,5 |
| II | EBI312II | 11,7 |
| IS | EBI312IS | 12,5 |
| RS | EBI312RS | 11,7 |
| SR | EBI312SR | 12,5 |
| OO | EBI312OO | 11,7 |
| OS | EBI312OS | 12,5 |

PACKAGING

L: 150 mm
D: 190 mm
H: 98 mm

1,2 kg

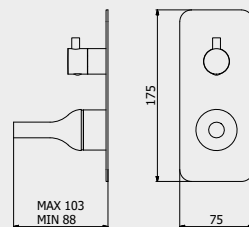

PORTATE | WATER FLOW | DÉBIT D'EAU

| | | |
|---------|----------|----------|
| 1 BAR | 2 BAR | 3 BAR |
| 9,5 l/m | 13,4 l/m | 16,9 l/m |

Built-in body to be purchased separately

Corpo incasso da acquistare separatamente

Corps intégré à acheter séparément



CODICE | CODE | CODE

INC312XXXN_19

COEFFICIENTE | COEFFICIENT | COEFFICIENT

3,3

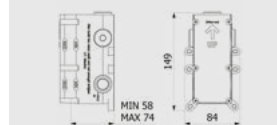

ARTICLE | ARTICOLO | ARTICLE

BI313



Exposed parts for manual wall mixer with 2 ways with shower kit
Set di parti esterne per miscelatore a parete a due vie completo di kit doccia
Partie extérieure pour mitigeur encastré à deux voies avec douchette

| CODE / COEFFICIENT | CODICE / COEFFICIENTE | CODE / COEFFICIENT |
|--------------------|-----------------------|--------------------|
| CC | EBI313CC | 10,4 |
| SS | EBI313SS | 13,0 |
| BO | EBI313BO | 12,5 |
| NP | EBI313NP | 12,5 |
| CF | EBI313CF | 15,6 |
| CS | EBI313CS | 16,6 |
| II | EBI313II | 15,6 |
| IS | EBI313IS | 16,6 |
| RS | EBI313RS | 15,6 |
| SR | EBI313SR | 16,6 |
| OO | EBI313OO | 15,6 |
| OS | EBI313OS | 16,6 |

PACKAGING

L: 370 mm
D: 270 mm
H: 80 mm

1,9 kg

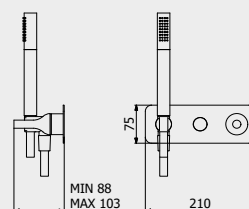

PORTATE | WATER FLOW | DÉBIT D'EAU

| | | |
|---------|----------|----------|
| 1 BAR | 2 BAR | 3 BAR |
| 9,8 l/m | 13,7 l/m | 16,6 l/m |

Built-in body to be purchased separately

Corpo incasso da acquistare separatamente

Corps intégré à acheter séparément



CODICE | CODE | CODE

INC313XXXN_19

COEFFICIENTE | COEFFICIENT | COEFFICIENT

3,6

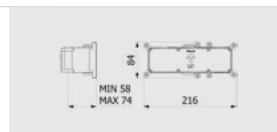

ARTICLE | ARTICOLO | ARTICLE

BI314



Exposed parts for manual wall mixer with 3 ways with shower kit
Set di parti esterne per miscelatore a parete a tre vie completo di kit doccia
Partie extérieure pour mitigeur encastré à trois voies avec douchette

| CODE / COEFFICIENT | CODICE / COEFFICIENTE | CODE / COEFFICIENT |
|--------------------|-----------------------|--------------------|
| CC | EBI314CC | 11,8 |
| SS | EBI314SS | 14,8 |
| BO | EBI314BO | 14,2 |
| NP | EBI314NP | 14,2 |
| CF | EBI314CF | 17,7 |
| CS | EBI314CS | 18,9 |
| II | EBI314II | 17,7 |
| IS | EBI314IS | 18,9 |
| RS | EBI314RS | 17,7 |
| SR | EBI314SR | 18,9 |
| OO | EBI314OO | 17,7 |
| OS | EBI314OS | 18,9 |

PACKAGING

L: 370 mm
D: 270 mm
H: 80 mm

1,9 kg

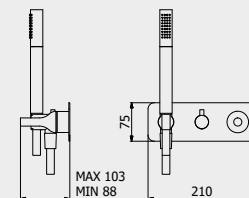

PORTATE | WATER FLOW | DÉBIT D'EAU

| | | |
|-------|--------|----------|
| 1 BAR | 2 BAR | 3 BAR |
| 8 l/m | 11 l/m | 13,7 l/m |

Built-in body to be purchased separately

Corpo incasso da acquistare separatamente

Corps intégré à acheter séparément



CODICE | CODE | CODE

INC314XXXN_19

COEFFICIENTE | COEFFICIENT | COEFFICIENT

3,7

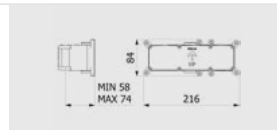

ARTICLE | ARTICOLO | ARTICLE

BI740



Two holes deck mounted bath filler mixer with shower kit
 Miscelatore Bordo vasca da appoggio due fori con doccia
 Mitigeur Bain/douche deux trous avec douchette

| CODE / COEFFICIENT | CODICE / COEFFICIENTE | |
|--------------------|-----------------------|------|
| CC | BI740CC | 16,3 |
| SS | BI740SS | 20,4 |
| CF | BI740CF | 24,5 |
| CS | BI740CS | 26,1 |
| II | BI740II | 24,5 |
| IS | BI740IS | 26,1 |
| RS | BI740RS | 24,5 |
| SR | BI740SR | 26,1 |
| OO | BI740OO | 24,5 |
| OS | BI740OS | 26,1 |

PACKAGING

L: 360 mm
 D: 220 mm
 H: 150 mm
 4,9 kg

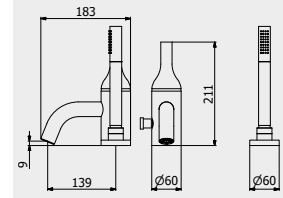

PORTATE | WATER FLOW | DÉBIT D'EAU

| | | |
|----------|--------|----------|
| 1 BAR | 2 BAR | 3 BAR |
| 20,5 l/m | 29 l/m | 35,7 l/m |

ARTICLE | ARTICOLO | ARTICLE

BI750



Deck mounted bath filler mixer
 Miscelatore bordo vasca da appoggio
 Mitigeur bain/douche

| CODE / COEFFICIENT | CODICE / COEFFICIENTE | |
|--------------------|-----------------------|------|
| CC | BI750CC | 12,1 |
| SS | BI750SS | 15,1 |
| CF | BI750CF | 18,2 |
| CS | BI750CS | 19,4 |
| II | BI750II | 18,2 |
| IS | BI750IS | 19,4 |
| RS | BI750RS | 18,2 |
| SR | BI750SR | 19,4 |
| OO | BI750OO | 18,2 |
| OS | BI750OS | 19,4 |

PACKAGING

L: 360 mm
 D: 220 mm
 H: 150 mm
 3,6 kg

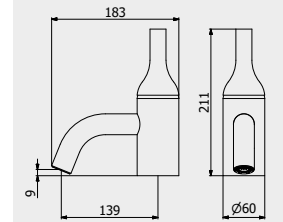

PORTATE | WATER FLOW | DÉBIT D'EAU

| | | |
|----------|--------|----------|
| 1 BAR | 2 BAR | 3 BAR |
| 20,5 l/m | 29 l/m | 35,7 l/m |

Batlo

ARTICLE | ARTICOLO | ARTICLE

BI250



Wall mounted bath filler complete with hand shower kit
 Bordo vasca esterno a parete completo di kit doccia
 Mitigeur Bain/douche Mural avec douchette encastrée

| CODE / COEFFICIENT | CODICE / COEFFICIENTE | |
|--------------------|-----------------------|------|
| CC | BI250CC | 14,6 |
| SS | BI250SS | 18,3 |
| BO | BI250BO | 17,5 |
| NP | BI250NP | 17,5 |
| CF | BI250CF | 21,9 |
| CS | BI250CS | 23,4 |
| II | BI250II | 21,9 |
| IS | BI250IS | 23,4 |
| RS | BI250RS | 21,9 |
| SR | BI250SR | 23,4 |
| OO | BI250OO | 21,9 |
| OS | BI250OS | 23,4 |

PACKAGING

L: 360 mm
 D: 220 mm
 H: 150 mm
 4,7 kg

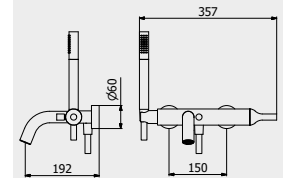

PORTATE | WATER FLOW | DÉBIT D'EAU

| | | |
|--------|--------|--------|
| 1 BAR | 2 BAR | 3 BAR |
| 10 l/m | 14 l/m | 18 l/m |

ARTICLE | ARTICOLO | ARTICLE

BI350



Wall mounted shower mixer with shower kit
 Doccia esterno a parete completo di kit doccia
 Mitigeur de douche externe avec flexible et douchette

| CODE / COEFFICIENT | CODICE / COEFFICIENTE | |
|--------------------|-----------------------|------|
| CC | BI350CC | 12,7 |
| SS | BI350SS | 15,9 |
| BO | BI350BO | 15,2 |
| NP | BI350NP | 15,2 |
| CF | BI350CF | 19,1 |
| CS | BI350CS | 20,3 |
| II | BI350II | 19,1 |
| IS | BI350IS | 20,3 |
| RS | BI350RS | 19,1 |
| SR | BI350SR | 20,3 |
| OO | BI350OO | 19,1 |
| OS | BI350OS | 20,3 |

PACKAGING

L: 360 mm
 D: 220 mm
 H: 150 mm
 4,2 kg

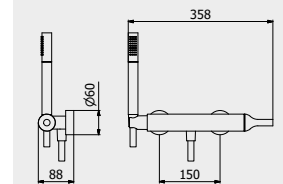

PORTATE | WATER FLOW | DÉBIT D'EAU

| | | |
|----------|----------|--------|
| 1 BAR | 2 BAR | 3 BAR |
| 12,4 l/m | 17,6 l/m | 22 l/m |

ARTICLE | ARTICOLO | ARTICLE

BI396



Five holes deck mounted bath filler with shower kit

Bordo vasca cinque fori con deviatore e kit doccia

Bain/douche cinq trous avec inverseur et Kit douche

CODE / COEFFICIENT | CODICE /
COEFFICIENTE | CODE / COEFFICIENT

| | | |
|------|---------|------|
| ● CC | BI396CC | 19,1 |
| ● SS | BI396SS | 23,9 |
| ● BO | BI396BO | 22,9 |
| ● NP | BI396NP | 22,9 |
| ● CF | BI396CF | 28,7 |
| ● CS | BI396CS | 30,6 |
| ● II | BI396II | 28,7 |
| ● IS | BI396IS | 30,6 |
| ● RS | BI396RS | 28,7 |
| ● SR | BI396SR | 30,6 |
| ● OO | BI396OO | 28,7 |
| ● OS | BI396OS | 30,6 |

PACKAGING

L: 400 mm
D: 250 mm
H: 140 mm

4,2 kg

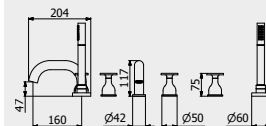

PORTATE | WATER FLOW | DÉBIT D'EAU

| | | |
|--------|--------|--------|
| 1 BAR | 2 BAR | 3 BAR |
| 14 l/m | 19 l/m | 24 l/m |

ARTICLE | ARTICOLO | ARTICLE

BI397



4 holes bath filler with overflow outlet connection, diverter and shower kit

Bordo vasca 4 fori per colonna riempimento con deviatore e kit doccia

Bain/douche 4 trous avec inverseur et Kit Douche pour remplissage ETP

CODE / COEFFICIENT | CODICE /
COEFFICIENTE | CODE / COEFFICIENT

| | | |
|------|---------|------|
| ● CC | BI397CC | 15,5 |
| ● SS | BI397SS | 19,4 |
| ● BO | BI397BO | 18,6 |
| ● NP | BI397NP | 18,6 |
| ● CF | BI397CF | 23,3 |
| ● CS | BI397CS | 24,8 |
| ● II | BI397II | 23,3 |
| ● IS | BI397IS | 24,8 |
| ● RS | BI397RS | 23,3 |
| ● SR | BI397SR | 24,8 |
| ● OO | BI397OO | 23,3 |
| ● OS | BI397OS | 24,8 |

PACKAGING

L: 400 mm
D: 250 mm
H: 140 mm

2,5 kg

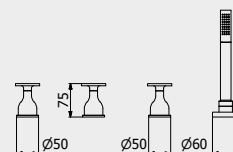

PORTATE | WATER FLOW | DÉBIT D'EAU

| | | |
|--------|--------|--------|
| 1 BAR | 2 BAR | 3 BAR |
| 12 l/m | 17 l/m | 22 l/m |

ARTICLE | ARTICOLO | ARTICLE

BI399



Free-standing bath filler with shower kit

Bordo vasca da terra con kit doccia

Bain douche complet alimentation au sol

CODE / COEFFICIENT | CODICE /
COEFFICIENTE | CODE / COEFFICIENT

| | | |
|------|----------|------|
| ● CC | EBI399CC | 38,6 |
| ● SS | EBI399SS | 48,3 |
| ● BO | EBI399BO | 46,3 |
| ● NP | EBI399NP | 46,3 |
| ● CF | EBI399CF | 57,9 |
| ● CS | EBI399CS | 61,8 |
| ● II | EBI399II | 57,9 |
| ● IS | EBI399IS | 61,8 |
| ● RS | EBI399RS | 57,9 |
| ● SR | EBI399SR | 61,8 |
| ● OO | EBI399OO | 57,9 |
| ● OS | EBI399OS | 61,8 |

PACKAGING

L: 1160 mm
D: 360 mm
H: 180 mm

15,6 kg

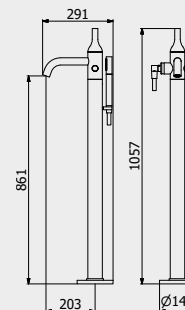

PORTATE | WATER FLOW | DÉBIT D'EAU

| | | |
|--------|--------|--------|
| 1 BAR | 2 BAR | 3 BAR |
| 14 l/m | 19 l/m | 24 l/m |

Built-in body to be purchased separately
AVAILABLE FROM JANUARY 2020Corpo incasso da acquistare separatamente
DISPONIBILE DA GENNAIO 2020Corps intégré à acheter séparément
DISPONIBLE À PARTIR DE JANVIER 2020

CODICE | CODE | CODE

INC399XXXN_19

COEFFICIENTE | COEFFICIENT | COEFFICIENT

2,8

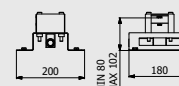

ARTICLE | ARTICOLO | ARTICLE

RU319



Wall mounted waterfall
Cascata a parete con erogazione diretta
Cascade murale



| CODE / COEFFICIENT CODICE / COEFFICIENTE | CODE / COEFFICIENT | COEFFICIENT |
|--|--------------------|-------------|
| CC | RU319CC | 12,8 |
| SS | RU319SS | 16,0 |
| BO | RU319BO | 15,4 |
| NP | RU319NP | 15,4 |
| CF | RU319CF | 19,2 |
| CS | RU319CS | 20,5 |
| II | RU319II | 19,2 |
| IS | RU319IS | 20,5 |
| RS | RU319RS | 19,2 |
| SR | RU319SR | 20,5 |
| OO | RU319OO | 19,2 |
| OS | RU319OS | 20,5 |

PACKAGING

L: 340 mm
D: 180 mm
H: 70 mm
3,1 kg

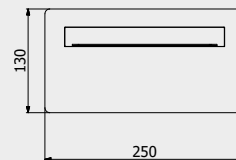

PORTATE | WATER FLOW | DÉBIT D'EAU

| | | |
|--------|----------|--------|
| 1 BAR | 2 BAR | 3 BAR |
| 13 l/m | 17,7 l/m | 20 l/m |

ARTICLE | ARTICOLO | ARTICLE

BI320



Wall mounted spout
Bocca d'erogazione a parete
Bec de remplissage mural



| CODE / COEFFICIENT CODICE / COEFFICIENTE | CODE / COEFFICIENT | COEFFICIENT |
|--|--------------------|-------------|
| CC | MT320CC | 2,1 |
| SS | MT320SS | 2,6 |
| BO | MT320BO | 2,5 |
| NP | MT320NP | 2,5 |
| CF | MT320CF | 3,2 |
| CS | MT320CS | 3,4 |
| II | MT320II | 3,2 |
| IS | MT320IS | 3,4 |
| RS | MT320RS | 3,2 |
| SR | MT320SR | 3,4 |
| OO | MT320OO | 3,2 |
| OS | MT320OS | 3,4 |

PACKAGING

L: 175 mm
D: 125 mm
H: 90 mm
0,2 kg

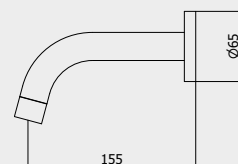

PORTATE | WATER FLOW | DÉBIT D'EAU

| | | |
|---------|-------|-------|
| 1 BAR | 2 BAR | 3 BAR |
| 6,5 l/m | 8 l/m | 8 l/m |

ARTICLE | ARTICOLO | ARTICLE

BI321



Short wall mounted spout
Bocca d'erogazione corta a parete
Bec de remplissage mural court



| CODE / COEFFICIENT CODICE / COEFFICIENTE | CODE / COEFFICIENT | COEFFICIENT |
|--|--------------------|-------------|
| CC | MT321CC | 2,5 |
| SS | MT321SS | 3,1 |
| BO | MT321BO | 3,0 |
| NP | MT321NP | 3,0 |
| CF | MT321CF | 3,8 |
| CS | MT321CS | 4,0 |
| II | MT321II | 3,8 |
| IS | MT321IS | 4,0 |
| RS | MT321RS | 3,8 |
| SR | MT321SR | 4,0 |
| OO | MT321OO | 3,8 |
| OS | MT321OS | 4,0 |

PACKAGING

L: 175 mm
D: 125 mm
H: 90 mm
0,2 kg

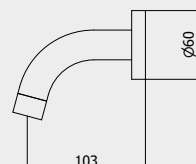

PORTATE | WATER FLOW | DÉBIT D'EAU

| | | |
|---------|-------|-------|
| 1 BAR | 2 BAR | 3 BAR |
| 6,5 l/m | 8 l/m | 8 l/m |

ARTICLE | ARTICOLO | ARTICLE

BI322



Long wall mounted spout
Bocca d'erogazione lunga a parete
Bec de remplissage mural long



| CODE / COEFFICIENT CODICE / COEFFICIENTE | CODE / COEFFICIENT | COEFFICIENT |
|--|--------------------|-------------|
| CC | MT322CC | 2,5 |
| SS | MT322SS | 3,1 |
| BO | MT322BO | 3,0 |
| NP | MT322NP | 3,0 |
| CF | MT322CF | 3,8 |
| CS | MT322CS | 4,0 |
| II | MT322II | 3,8 |
| IS | MT322IS | 4,0 |
| RS | MT322RS | 3,8 |
| SR | MT322SR | 4,0 |
| OO | MT322OO | 3,8 |
| OS | MT322OS | 4,0 |

PACKAGING

L: 175 mm
D: 125 mm
H: 90 mm
0,2 kg

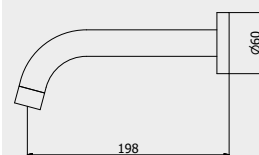

PORTATE | WATER FLOW | DÉBIT D'EAU

| | | |
|---------|-------|-------|
| 1 BAR | 2 BAR | 3 BAR |
| 6,5 l/m | 8 l/m | 8 l/m |

ARTICLE | ARTICOLO | ARTICLE

BI706



Exposed parts for bidet spray complete with mixer

Set di parti esterne per Idroscopino igienico con miscelatore

Partie extérieure pour douchette hygiénique avec mitigeur

CODE / COEFFICIENT | CODICE /
COEFFICIENTE | CODE / COEFFICIENT

| | | |
|------|-----------|------|
| ● CC | EBI706CC | 9,9 |
| ● SS | EBI706SS | 12,4 |
| ● BO | EBI706EBO | 11,9 |
| ● NP | EBI706NP | 11,9 |
| ● CF | EBI706CF | 14,9 |
| ● CS | EBI706CS | 15,8 |
| ● II | EBI706II | 14,9 |
| ● IS | EBI706IS | 15,8 |
| ● RS | EBI706RS | 14,9 |
| ● SR | EBI706SR | 15,8 |
| ● OO | EBI706OO | 14,9 |
| ● OS | EBI706OS | 15,8 |

PACKAGING

L: 370 mm
D: 270 mm
H: 80 mm

3,1 kg

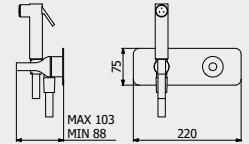

PORTATE | WATER FLOW | DÉBIT D'EAU

| | | |
|---------|---------|-------|
| 1 BAR | 2 BAR | 3 BAR |
| 2,3 l/m | 3,2 l/m | 4 l/m |

Built-in body to be purchased
separatelyCorpo incasso da acquistare
separatamenteCorps intégré à acheter
séparément

CODICE | CODE | CODE

INC206XXXN_19

COEFFICIENTE | COEFFICIENT | COEFFICIENT

2,9

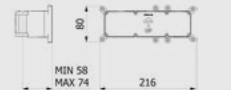

ARTICLE | ARTICOLO | ARTICLE

BI370



Single Lever kitchen mixer

Miscelatore lavello monoforo

Évier de cuisine

CODE / COEFFICIENT | CODICE /
COEFFICIENTE | CODE / COEFFICIENT

| | | |
|------|---------|------|
| ● CC | BI370CC | 10,8 |
| ● SS | BI370SS | 13,5 |
| ● BO | BI370BO | 13,0 |
| ● NP | BI370NP | 13,0 |
| ● CF | BI370CF | 16,2 |
| ● CS | BI370CS | 17,3 |
| ● II | BI370II | 16,2 |
| ● IS | BI370IS | 17,3 |
| ● RS | BI370RS | 16,2 |
| ● SR | BI370SR | 17,3 |
| ● OO | BI370OO | 16,2 |
| ● OS | BI370OS | 17,3 |

PACKAGING

L: 425 mm
D: 188 mm
H: 98 mm

2,7 kg

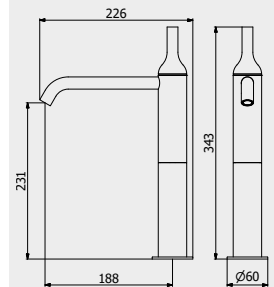

PORTATE | WATER FLOW | DÉBIT D'EAU

| | | |
|---------|----------|----------|
| 1 BAR | 2 BAR | 3 BAR |
| 9,2 l/m | 13,3 l/m | 16,6 l/m |



SNATCH / ACCESSORIES COLLECTION

ARTICLE | ARTICOLO | ARTICLE

HJ001



Wall soap-holder
Porta sapone a muro
Porte distributeur de savon encastré

CODICE / COEFFICIENTE | CODE / COEFFICIENT

| | | |
|----|---------|-----|
| CC | HJ001CC | 5,5 |
| SS | HJ001SS | 5,7 |
| BO | HJ001BO | 5,7 |
| NP | HJ001NP | 5,7 |
| CF | HJ001CF | 5,7 |
| CS | HJ001CS | 5,7 |
| II | HJ001II | 5,7 |
| IS | HJ001IS | 5,7 |
| RS | HJ001RS | 5,7 |
| SR | HJ001SR | 5,7 |
| OO | HJ001OO | 5,7 |
| OS | HJ001OS | 5,7 |

PACKAGING

| | | | |
|--|------------------------------------|--|--------|
| | L: 150 mm D: 190 mm H: 98 mm | | 0,4 kg |
|--|------------------------------------|--|--------|

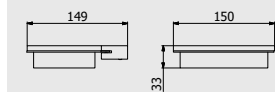

ARTICLE | ARTICOLO | ARTICLE

HJ003



Wall toothbrush holder
Porta spazzolino a muro
Porte brosse à dents encastré

CODICE / COEFFICIENTE | CODE / COEFFICIENT

| | | |
|----|---------|-----|
| CC | HJ003CC | 6,1 |
| SS | HJ003SS | 6,3 |
| BO | HJ003BO | 6,3 |
| NP | HJ003NP | 6,3 |
| CF | HJ003CF | 6,3 |
| CS | HJ003CS | 6,3 |
| II | HJ003II | 6,3 |
| IS | HJ003IS | 6,3 |
| RS | HJ003RS | 6,3 |
| SR | HJ003SR | 6,3 |
| OO | HJ003OO | 6,3 |
| OS | HJ003OS | 6,3 |

PACKAGING

| | | | |
|--|------------------------------------|--|--------|
| | L: 175 mm D: 125 mm H: 90 mm | | 0,2 kg |
|--|------------------------------------|--|--------|

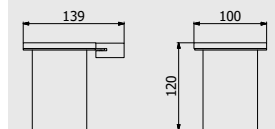

ARTICLE | ARTICOLO | ARTICLE

HJ016



Soap dispenser
Porta sapone da appoggio
Porte distributeur de savon

CODICE / COEFFICIENTE | CODE / COEFFICIENT

| | | |
|----|---------|-----|
| CC | HJ016CC | 2,2 |
| SS | HJ016SS | 2,4 |
| BO | HJ016BO | 2,4 |
| NP | HJ016NP | 2,4 |
| CF | HJ016CF | 2,4 |
| CS | HJ016CS | 2,4 |
| II | HJ016II | 2,4 |
| IS | HJ016IS | 2,4 |
| RS | HJ016RS | 2,4 |
| SR | HJ016SR | 2,4 |
| OO | HJ016OO | 2,4 |
| OS | HJ016OS | 2,4 |

PACKAGING

| | | | |
|--|------------------------------------|--|--------|
| | L: 150 mm D: 190 mm H: 98 mm | | 1,1 kg |
|--|------------------------------------|--|--------|

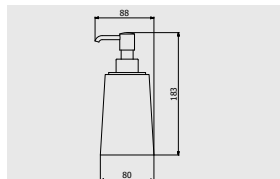

ARTICLE | ARTICOLO | ARTICLE

HJ017



Soap holder
Porta sapone da appoggio
Porte savon

CODE / COEFFICIENT | CODE / COEFFICIENT

| | | |
|----|---------|-----|
| CC | HJ017CC | 3,8 |
|----|---------|-----|

PACKAGING

| | | | |
|--|------------------------------------|--|--------|
| | L: 175 mm D: 125 mm H: 90 mm | | 0,5 kg |
|--|------------------------------------|--|--------|

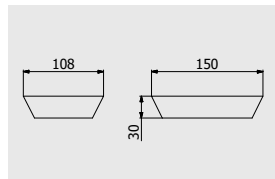

ARTICLE | ARTICOLO | ARTICLE

HJ010

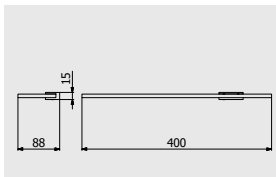

Shelf

Mensola

Etagère

CODICE / COEFFICIENTE | CODE /
COEFFICIENT | CODE / COEFFICIENT

| | | |
|----|---------|-----|
| CC | HJ010CC | 5,1 |
| SS | HJ010SS | 5,3 |
| BO | HJ010BO | 5,3 |
| NP | HJ010NP | 5,3 |
| CF | HJ010CF | 5,3 |
| CS | HJ010CS | 5,3 |
| II | HJ010II | 5,3 |
| IS | HJ010IS | 5,3 |
| RS | HJ010RS | 5,3 |
| SR | HJ010SR | 5,3 |
| OO | HJ010OO | 5,3 |
| OS | HJ010OS | 5,3 |

PACKAGING

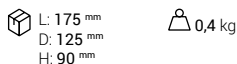

ARTICLE | ARTICOLO | ARTICLE

HJ011

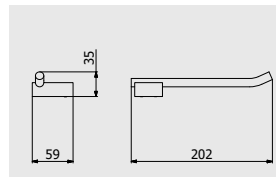

Toilet paper holder

Porta rotolo

Porte rouleaux de toilette

CODICE / COEFFICIENTE | CODE /
COEFFICIENT | CODE / COEFFICIENT

| | | |
|----|---------|-----|
| CC | HJ011CC | 3,5 |
| SS | HJ011SS | 4,4 |
| BO | HJ011BO | 4,4 |
| NP | HJ011NP | 4,2 |
| CF | HJ011CF | 5,3 |
| CS | HJ011CS | 5,7 |
| II | HJ011II | 5,3 |
| IS | HJ011IS | 5,7 |
| RS | HJ011RS | 5,3 |
| SR | HJ011SR | 5,7 |
| OO | HJ011OO | 5,7 |
| OS | HJ011OS | 5,3 |

PACKAGING

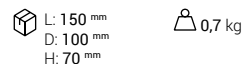

ARTICLE | ARTICOLO | ARTICLE

HJ009

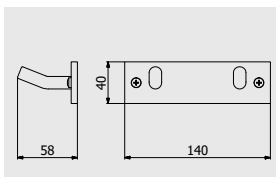

Double robe hook

Doppio appendino a parete

Double cintre

CODICE / COEFFICIENTE | CODE /
COEFFICIENT | CODE / COEFFICIENT

| | | |
|----|---------|-----|
| CC | HJ009CC | 3,4 |
| SS | HJ009SS | 4,3 |
| BO | HJ009BO | 4,3 |
| NP | HJ009NP | 4,3 |
| CF | HJ009CF | 5,1 |
| CS | HJ009CS | 5,4 |
| II | HJ009II | 5,4 |
| IS | HJ009IS | 5,4 |
| RS | HJ009RS | 5,1 |
| SR | HJ009SR | 5,4 |
| OO | HJ009OO | 5,1 |
| OS | HJ009OS | 5,4 |

PACKAGING

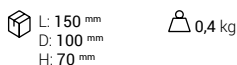

ARTICLE | ARTICOLO | ARTICLE

HJ004

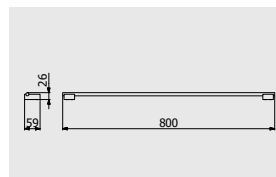

Towel holder

Porta salvietta

Porte-serviette

CODICE / COEFFICIENTE | CODE /
COEFFICIENT | CODE / COEFFICIENT

| | | |
|----|---------|------|
| CC | HJ004CC | 7,5 |
| SS | HJ004SS | 9,4 |
| BO | HJ004BO | 9,4 |
| NP | HJ004NP | 9,4 |
| CF | HJ004CF | 11,3 |
| CS | HJ004CS | 12,0 |
| II | HJ004II | 11,3 |
| IS | HJ004IS | 12,0 |
| RS | HJ004RS | 11,3 |
| SR | HJ004SR | 12,0 |
| OO | HJ004OO | 11,3 |
| OS | HJ004OS | 12,0 |

PACKAGING

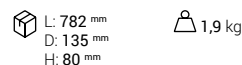

ARTICLE | ARTICOLO | ARTICLE

HJ014

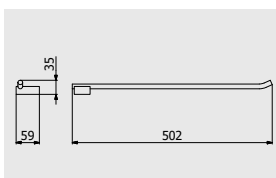

Towel holder

Porta salvietta

Porte-serviette

CODICE / COEFFICIENTE | CODE /
COEFFICIENT | CODE / COEFFICIENT

| | | |
|----|---------|-----|
| CC | HJ014CC | 5,1 |
| SS | HJ014SS | 6,4 |
| BO | HJ014BO | 6,4 |
| NP | HJ014NP | 6,4 |
| CF | HJ014CF | 7,7 |
| CS | HJ014CS | 8,2 |
| II | HJ014II | 7,7 |
| IS | HJ014IS | 8,2 |
| RS | HJ014RS | 7,7 |
| SR | HJ014SR | 8,2 |
| OO | HJ014OO | 7,7 |
| OS | HJ014OS | 8,2 |

PACKAGING

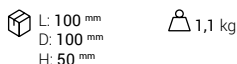

ARTICLE | ARTICOLO | ARTICLE

HJ006

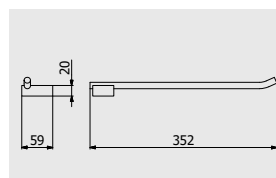

Towel holder

Porta salvietta

Porte-serviette

CODICE / COEFFICIENTE | CODE /
COEFFICIENT | CODE / COEFFICIENT

| | | |
|----|---------|-----|
| CC | HJ006CC | 4,9 |
| SS | HJ006SS | 6,1 |
| BO | HJ006BO | 6,1 |
| NP | HJ006NP | 6,1 |
| CF | HJ006CF | 7,4 |
| CS | HJ006CS | 7,8 |
| II | HJ006II | 7,4 |
| IS | HJ006IS | 7,8 |
| RS | HJ006RS | 7,4 |
| SR | HJ006SR | 7,8 |
| OO | HJ006OO | 7,4 |
| OS | HJ006OS | 7,8 |

PACKAGING

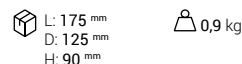

ARTICLE | ARTICOLO | ARTICLE

HJ007

Ring Towel holder

Porta salvietta ad anello

Porte-serviette anneau

CODICE / COEFFICIENTE | CODE / COEFFICIENT

| | | |
|----|---------|-----|
| CC | HJ007CC | 5,0 |
| SS | HJ007SS | 6,3 |
| BO | HJ007BO | 6,3 |
| NP | HJ007NP | 6,3 |
| CF | HJ007CF | 7,5 |
| CS | HJ007CS | 8,0 |
| II | HJ007II | 7,5 |
| IS | HJ007IS | 8,0 |
| RS | HJ007RS | 7,5 |
| SR | HJ007SR | 8,0 |
| OO | HJ007OO | 7,5 |
| OS | HJ007OS | 8,0 |

PACKAGING

| | | | |
|--|-----------|--|--------|
| | L: 340 mm | | 1,9 kg |
| | D: 180 mm | | |
| | H: 70 mm | | |

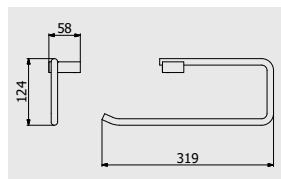

ARTICLE | ARTICOLO | ARTICLE

HJ012

Toilet brush holder

Porta scopino da terra

Porte balayette au sol

CODICE / COEFFICIENTE | CODE / COEFFICIENT

| | | |
|----|---------|------|
| CC | HJ012CC | 7,8 |
| SS | HJ012SS | 9,8 |
| BO | HJ012BO | 9,8 |
| NP | HJ012NP | 9,8 |
| CF | HJ012CF | 11,7 |
| CS | HJ012CS | 12,5 |
| II | HJ012II | 11,7 |
| IS | HJ012IS | 12,5 |
| RS | HJ012RS | 11,7 |
| SR | HJ012SR | 12,5 |
| OO | HJ012OO | 11,7 |
| OS | HJ012OS | 12,5 |

PACKAGING

| | | | |
|--|-----------|--|--------|
| | L: 100 mm | | 1,8 kg |
| | D: 100 mm | | |
| | H: 50 mm | | |

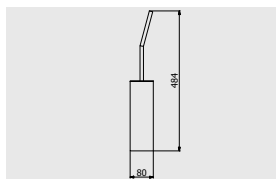

ARTICLE | ARTICOLO | ARTICLE

HJ015

Toothbrush holder

Porta spazzolino

Porte brosse à dents

CODICE / COEFFICIENTE | CODE / COEFFICIENT

| | | |
|----|---------|-----|
| CC | HJ015CC | 2,8 |
|----|---------|-----|

PACKAGING

| | | | |
|--|-----------|--|--------|
| | L: 175 mm | | 0,6 kg |
| | D: 125 mm | | |
| | H: 90 mm | | |

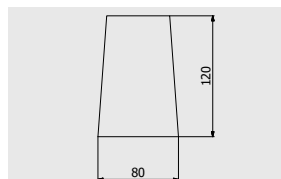

ARTICLE | ARTICOLO | ARTICLE

HJ018

Box

Scatola

Boîte

CODICE / COEFFICIENTE | CODE / COEFFICIENT

| | | |
|----|---------|-----|
| CC | HJ018CC | 4,1 |
| SS | HJ018SS | 4,3 |
| BO | HJ018BO | 4,3 |
| NP | HJ018NP | 4,3 |
| CF | HJ018CF | 4,3 |
| CS | HJ018CS | 4,3 |
| II | HJ018II | 4,3 |
| IS | HJ018IS | 4,3 |
| RS | HJ018RS | 4,3 |
| SR | HJ018SR | 4,3 |
| OO | HJ018OO | 4,3 |
| OS | HJ018OS | 4,3 |

PACKAGING

| | | | |
|--|-----------|--|--------|
| | L: 240 mm | | 1,2 kg |
| | D: 215 mm | | |
| | H: 110 mm | | |

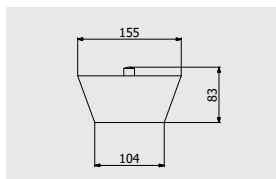

Batlò

ONLYONE

Simplify everything in a single gesture.

Semplificare tutto in un unico gesto.
Simplifiez tout à travers un seul geste.

Innovation begins with the discovery of ancient forms for new purposes. In ONLY ONE, the features of a traditional tube, as a typical industrial water container, shape a new product with a traditional and yet original design.

Innovation also means to combine aesthetics and high practicality: that's why ONLY ONE focuses on a fast and simple gestural action, enabling to open and direct the water flow with just one hand, thus creating the effect of a small man-operated waterfall.

L'innovazione parte dalla riscoperta di antiche forme per nuovi utilizzi.

In ONLY ONE, le fattezze di un tubo, tradizionale contenitore industriale d'acqua, modellano un nuovo prodotto, dal design tradizionale e al contempo originale.

Innovazione significa anche affiancare estetica e alta funzionalità: ecco perché ONLY ONE punta su una gestualità veloce e semplice, che con una sola mano permette di aprire e direzionare il flusso d'acqua, creando l'effetto di una piccola cascata manovrata dall'uomo.

L'innovation commence par la redécouverte de formes anciennes pour des nouveaux usages. Dans ONLY ONE, les formes d'un tuyau, le traditionnel réservoir d'eau industriel, façonnent un nouveau produit au design à la fois traditionnel et original. Innovation c'est aussi allier esthétique et haute fonctionnalité: c'est pourquoi ONLY ONE se concentre sur une gestualité simple et rapide qui, d'une seule main, ouvre et dirige l'écoulement d'eau, créant ainsi l'effet d'une petite cascade manœuvrée par l'homme.



LEAD FREE



ZINC FREE



CASCADE





Onlyone

DESIGN
LORENZO DAMIANI

“ With this product, I wanted to go back to the archetype of water distribution: a simple tube (originally a hose), from which water flows without technological mediations. The innovation lies in water management, where the whole body becomes the handle.”

Con questo prodotto ho voluto ritornare all'archetipo della distribuzione dell'acqua: un semplice tubo (all'origine canna) dal quale sgorga senza mediazioni tecnologiche. L'invenzione sta nella gestione dell'acqua dove tutto il corpo diventa maniglia.

Avec ce produit, j'ai voulu revenir à l'archétype de la distribution de l'eau: un tube simple (à l'origine un tuyau d'arrosage) duquel elle jaillit sans médiation technologique. L'innovation concerne la gestion de l'eau, du moment que le corps entier du robinet devient la poignée de commande. ”

Lorenzo Damiani design for ONLYONE

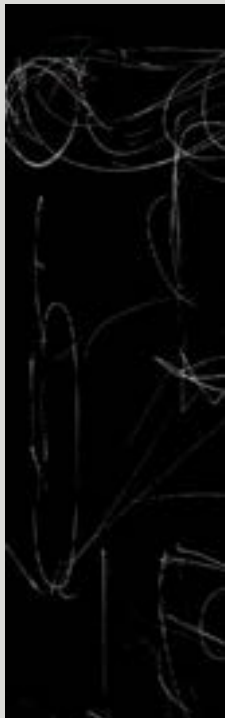



Onlyone



- ↑ 00200CC
Monohole washbasin mixer
Miscelatore lavabo monoforo
Mitigeur lavabo
- 00202CC
Tall monohole washbasin mixer
Miscelatore lavabo monoforo alto
Mitigeur lavabo haut



Onlyone





Onlyone

← 00200CC
Monohole washbasin mixer
Miscelatore lavabo monoforo
Mitigeur lavabo

↗ 00392CC
Three holes washbasin set with low spout
Lavabo tre fori a bocca bassa
Lavabo trois trous bec bas

→ 00209CC
Wall mounted washbasin mixer
Miscelatore lavabo a parete
Mitigeur lavabo mural





- ↖ 00350CC
Wall mounted shower mixer with shower kit
Doccia esterno a parete completo di kit doccia
Mitigeur de douche externe avec flexible et douchette

- 00800CC
Shower column with mixer and shower kit
Colonna doccia con miscelatore e e kit doccia
Colonne de douche avec mitigeur et kit douche







Onlyone

← 00314CC

Three ways wall shower mixer complete with shower kit

Miscelatore doccia a parete con deviatore tre vie e doccino integrato

Mitigeur douche mural trois voies avec inverseur et douchette encastrée

↑ 00250CC

→ Wall mounted bath filler complete with hand shower kit

Bordo vasca esterno a parete completo di kit doccia

Mitigeur Bain/douche Mural avec douchette encastrée





↑ 00399CC

Free-standing bath filler with shower kit
Bordo vasca da terra con kit doccia
Bain douche complet alimentation au sol



ARTICLE | ARTICOLO | ARTICLE

00200



Monohole washbasin mixer complete with drain
 Miscelatore lavabo monoforo completo di scarico automatico
 Mitigeur lavabo complet avec bonde automatique

CODICE / COEFFICIENTE | CODE / COEFFICIENT
 CC 00200CC 12,5

PACKAGING

L: 340 mm
 D: 180 mm
 H: 70 mm

2,5 kg

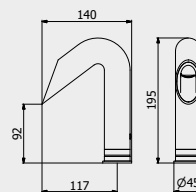

PORTATE | WATER FLOW | DÉBIT D'EAU

| | | |
|---------|---------|----------|
| 1 BAR | 2 BAR | 3 BAR |
| 5,8 l/m | 8,4 l/m | 10,3 l/m |

ARTICLE | ARTICOLO | ARTICLE

00202



Tall monohole washbasin mixer complete with drain
 Miscelatore lavabo monoforo alto completo di scarico automatico
 Mitigeur lavabo haut complet avec bonde automatique

CODICE / COEFFICIENTE | CODE / COEFFICIENT
 CC 00202CC 14,8

PACKAGING

L: 425 mm
 D: 188 mm
 H: 98 mm

3,1 kg

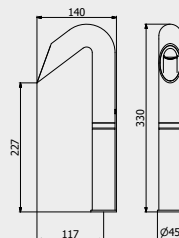

PORTATE | WATER FLOW | DÉBIT D'EAU

| | | |
|---------|---------|----------|
| 1 BAR | 2 BAR | 3 BAR |
| 5,8 l/m | 8,4 l/m | 10,3 l/m |

Onlyone

ARTICLE | ARTICOLO | ARTICLE

00209



Wall mounted washbasin mixer complete with drain
 Miscelatore lavabo a parete completo di scarico automatico
 Mitigeur lavabo mural complet avec bonde automatique

CODICE / COEFFICIENTE | CODE / COEFFICIENT
 CC 00209CC 13,3

PACKAGING

L: 340 mm
 D: 180 mm
 H: 70 mm

2,0 kg

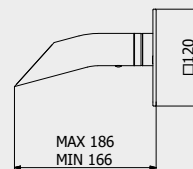

PORTATE | WATER FLOW | DÉBIT D'EAU

| | | |
|---------|---------|---------|
| 1 BAR | 2 BAR | 3 BAR |
| 5,5 l/m | 7,5 l/m | 9,3 l/m |

ARTICLE | ARTICOLO | ARTICLE

00220



Monohole bidet mixer complete with drain

Miscelatore bidet monoforo completo di scarico automatico

Mitigeur bidet complet avec bonde automatique

CODICE / COEFFICIENTE | CODE /
COEFFICIENT | CODE / COEFFICIENT

CC 00220CC 12,5

PACKAGING

L: 340 mm
D: 180 mm
H: 70 mm

2,3 kg

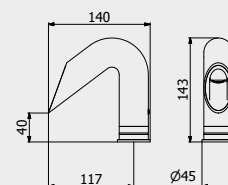

PORTATE | WATER FLOW | DÉBIT D'EAU

| 1 BAR | 2 BAR | 3 BAR |
|---------|---------|----------|
| 5,8 l/m | 8,4 l/m | 10,3 l/m |

ARTICLE | ARTICOLO | ARTICLE

00300



Exposed parts for manual wall mixer

Set di parti esterne per miscelatore a parete ad una via

Partie extérieure pour mitigeur encastré à une voie

CODICE / COEFFICIENTE | CODE /
COEFFICIENT | CODE / COEFFICIENT

CC E00300CC 4,1

PACKAGING

L: 150 mm
D: 190 mm
H: 98 mm

1,4 kg

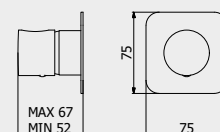

PORTATE | WATER FLOW | DÉBIT D'EAU

| 1 BAR | 2 BAR | 3 BAR |
|----------|----------|--------|
| 11,5 l/m | 16,3 l/m | 20 l/m |

Built-in body to be purchased
separatelyCorpo incasso da acquistare
separatamenteCorps intégré à acheter
séparément

CODICE | CODE | CODE

INC300XXXN_19

COEFFICIENTE | COEFFICIENT | COEFFICIENT

1,8

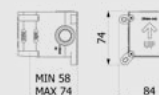

ARTICLE | ARTICOLO | ARTICLE

00310



Exposed parts for manual wall mixer with two ways diverter

Miscelatore doccia a parete con deviatore due vie

Mitigeur douche mural deux voies avec inverseur

CODICE / COEFFICIENTE | CODE /
COEFFICIENT | CODE / COEFFICIENT

CC E00310CC 6,1

PACKAGING

L: 150 mm
D: 190 mm
H: 98 mm

2,0 kg

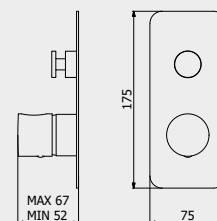

PORTATE | WATER FLOW | DÉBIT D'EAU

| 1 BAR | 2 BAR | 3 BAR |
|---------|----------|--------|
| 9,2 l/m | 12,8 l/m | 16 l/m |

Built-in body to be purchased
separatelyCorpo incasso da acquistare
separatamenteCorps intégré à acheter
séparément

CODICE | CODE | CODE

INC310XXXN_19

COEFFICIENTE | COEFFICIENT | COEFFICIENT

3,3

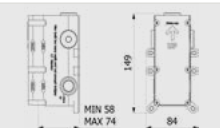

ARTICLE | ARTICOLO | ARTICLE

00312



Exposed parts for manual wall mixer with three ways diverter
Set di parti esterne per miscelatore a parete a tre vie
Mitigeur douche mural trois voies avec inverseur

CODICE / COEFFICIENTE | CODE / COEFFICIENT
CC E00312CC 7,4

PACKAGING

L: 150 mm
D: 190 mm
H: 98 mm
2,4 kg

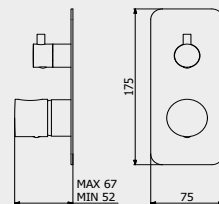

PORTATE | WATER FLOW | DÉBIT D'EAU

| | | |
|---------|----------|----------|
| 1 BAR | 2 BAR | 3 BAR |
| 8,3 l/m | 11,7 l/m | 14,3 l/m |

Built-in body to be purchased separately

Corpo incasso da acquistare separatamente
Corps intégré à acheter séparément



CODICE | CODE | CODE

INC312XXXN_19

COEFFICIENTE | COEFFICIENT | COEFFICIENT

3,3

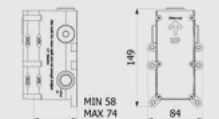

ARTICLE | ARTICOLO | ARTICLE

00313



Exposed parts for manual wall mixer with 2 ways with shower kit
Set di parti esterne per miscelatore a parete a due vie completo di kit doccia
Partie extérieure pour mitigeur encastré à deux voies avec douchette

CODICE / COEFFICIENTE | CODE / COEFFICIENT
CC E00313CC 10,1

PACKAGING

L: 370 mm
D: 270 mm
H: 80 mm
2,6 kg

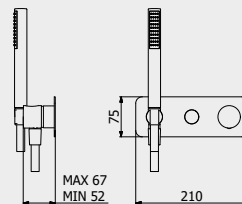

PORTATE | WATER FLOW | DÉBIT D'EAU

| | | |
|--------|----------|----------|
| 1 BAR | 2 BAR | 3 BAR |
| 10 l/m | 14,1 l/m | 17,2 l/m |

Built-in body to be purchased separately

Corpo incasso da acquistare separatamente
Corps intégré à acheter séparément



CODICE | CODE | CODE

INC313XXXN_19

COEFFICIENTE | COEFFICIENT | COEFFICIENT

3,6



Onlyone

ARTICLE | ARTICOLO | ARTICLE

00314



Exposed parts for manual wall mixer with 3 ways with shower kit
Set di parti esterne per miscelatore a parete a tre vie completo di kit doccia
Partie extérieure pour mitigeur encastré à trois voies avec douchette

CODICE / COEFFICIENTE | CODE / COEFFICIENT
CC E00314CC 11,4

PACKAGING

L: 370 mm
D: 270 mm
H: 80 mm
2,9 kg

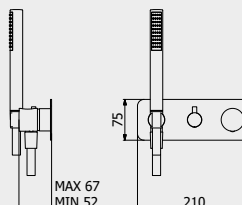

PORTATE | WATER FLOW | DÉBIT D'EAU

| | | |
|---------|----------|----------|
| 1 BAR | 2 BAR | 3 BAR |
| 8,3 l/m | 11,7 l/m | 14,3 l/m |

Built-in body to be purchased separately

Corpo incasso da acquistare separatamente
Corps intégré à acheter séparément



CODICE | CODE | CODE

INC314XXXN_19

COEFFICIENTE | COEFFICIENT | COEFFICIENT

3,7



ARTICLE | ARTICOLO | ARTICLE

00250



Wall mounted bath filler complete with hand shower kit

Bordo vasca esterno a parete completo di kit doccia

Mitigeur Bain/douche Mural avec douchette encastrée

CODICE / COEFFICIENTE | CODE /
COEFFICIENT | CODE / COEFFICIENT

CC 00250CC 23,4

PACKAGING

L: 400 mm
D: 250 mm
H: 140 mm

5,3 kg

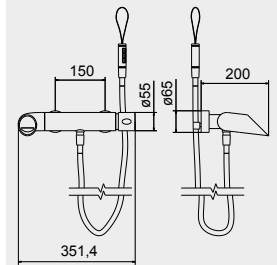

PORTATE | WATER FLOW | DÉBIT D'EAU

| 1 BAR | 2 BAR | 3 BAR |
|--------|----------|--------|
| 13 l/m | 19,5 l/m | 24 l/m |

ARTICLE | ARTICOLO | ARTICLE

00350



Wall mounted shower mixer with shower kit

Doccia esterno a parete completo di kit doccia

Mitigeur de douche externe avec flexible et douchette

CODICE / COEFFICIENTE | CODE /
COEFFICIENT | CODE / COEFFICIENT

CC 00350CC 16,9

PACKAGING

L: 360 mm
D: 220 mm
H: 150 mm

3,6 kg

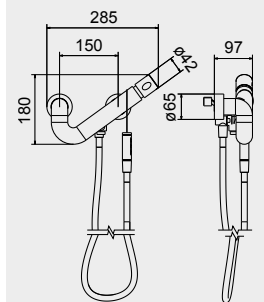

PORTATE | WATER FLOW | DÉBIT D'EAU

| 1 BAR | 2 BAR | 3 BAR |
|---------|---------|---------|
| 7,5 l/m | 8,5 l/m | 9,3 l/m |

ARTICLE | ARTICOLO | ARTICLE

00740



2 holes deck mounted bath filler mixer with shower kit

Miscelatore bordo vasca da appoggio due fori con doccino

Mitigeur bain/douche 2 trous avec douchette

CODICE / COEFFICIENTE | CODE /
COEFFICIENT | CODE / COEFFICIENT

CC 00740CC 30,4

PACKAGING

L: 353 mm
D: 225 mm
H: 226 mm

7,1 kg

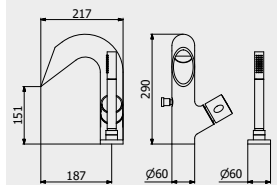

PORTATE | WATER FLOW | DÉBIT D'EAU

| 1 BAR | 2 BAR | 3 BAR |
|--------|--------|--------|
| 19 l/m | 28 l/m | 34 l/m |



ARTICLE | ARTICOLO | ARTICLE

00750



Deck mounted bath filler mixer with shower kit

Miscelatore bordo vasca da appoggio

Mitigeur bain/douche

CODICE / COEFFICIENTE | CODE / COEFFICIENT
 CC 00750CC 24,8

PACKAGING

L: 353 mm
 D: 225 mm
 H: 226 mm

6,5 kg

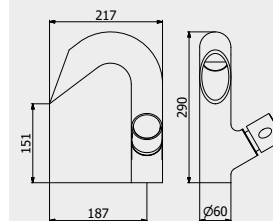

PORTATE | WATER FLOW | DÉBIT D'EAU

| | | |
|--------|--------|--------|
| 1 BAR | 2 BAR | 3 BAR |
| 19 l/m | 28 l/m | 34 l/m |

ARTICLE | ARTICOLO | ARTICLE

00396



Five holes deck mounted bath filler with shower kit

Bordo vasca cinque fori con deviatore e kit doccia

Bain/douche cinq trous avec inverseur et Kit Douche

CODICE / COEFFICIENTE | CODE / COEFFICIENT
 CC 00396CC 21,6

PACKAGING

L: 455 mm
 D: 310 mm
 H: 75 mm

5 kg

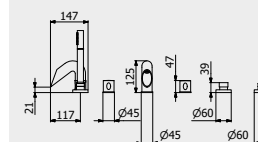

PORTATE | WATER FLOW | DÉBIT D'EAU

| | | |
|-------|--------|--------|
| 1 BAR | 2 BAR | 3 BAR |
| 9 l/m | 28 l/m | 34 l/m |

Onlyone

ARTICLE | ARTICOLO | ARTICLE

00397



4 holes bath filler with overflow outlet connection, diverter and shower kit

Bordo vasca 4 fori per colonna riempimento con deviatore e kit doccia

Bain/douche 4 trous avec inverseur et kit douche pour remplissage ETP

CODICE / COEFFICIENTE | CODE / COEFFICIENT
 CC 00397CC 14,3

PACKAGING

L: 455 mm
 D: 310 mm
 H: 75 mm

3,8 kg

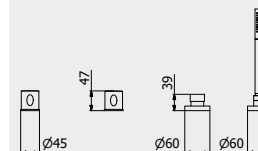

PORTATE | WATER FLOW | DÉBIT D'EAU

| | | |
|-------|--------|--------|
| 1 BAR | 2 BAR | 3 BAR |
| 9 l/m | 28 l/m | 34 l/m |

ARTICLE | ARTICOLO | ARTICLE

00399



Free-standing bath filler with shower kit

Bordo vasca da terra con kit doccia

Bain douche complet alimentation au sol

CODICE / COEFFICIENTE | CODICE /
COEFFICIENTE | CODE / COEFFICIENT

CC E00399CC 56,2

PACKAGING

L: 1160 mm
D: 360 mm
H: 180 mm

20,6 kg

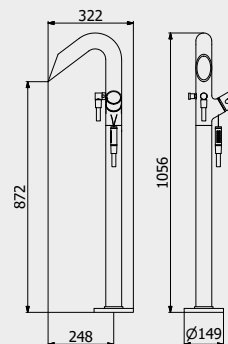

PORTATE | WATER FLOW | DÉBIT D'EAU

1 BAR 2 BAR 3 BAR
19 l/m 28 l/m 34 l/mBuilt-in body to be purchased separately
AVAILABLE FROM JANUARY 2020Corpo incasso da acquistare separatamente
DISPONIBILE DA GENNAIO 2020Corps intégré à acheter séparément
DISPONIBLE À PARTIR DE JANVIER 2020

CODICE | CODE | CODE

INC399XXXN_19

COEFFICIENTE | COEFFICIENT | COEFFICIENT

2,8

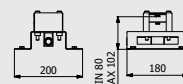

ARTICLE | ARTICOLO | ARTICLE

RU318



Built-in wall mounted waterfall spout

Cascata a parete con erogazione a lama esterna

Cascade murale avc bec externe

CODE / COEFFICIENT | CODICE /
COEFFICIENTE | CODE / COEFFICIENT

CC RU318CC 22,9

SS RU318SS 28,6

BO RU318BO 27,5

NP RU318NP 27,5

CF RU318CF 34,4

CS RU318CS 36,6

II RU318II 34,4

IS RU318IS 36,6

RS RU318RS 34,4

SR RU318SR 36,6

OO RU318OO 34,4

OS RU318OS 36,6

PACKAGING

L: 340 mm
D: 180 mm
H: 70 mm

4,0 kg

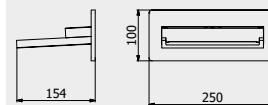

PORTATE | WATER FLOW | DÉBIT D'EAU

1 BAR 2 BAR 3 BAR
13 l/m 17 l/m 20 l/m

ARTICLE | ARTICOLO | ARTICLE

RU319



Wall mounted waterfall

Cascata a parete con erogazione diretta

Cascade murale

CODE / COEFFICIENT | CODICE /
COEFFICIENTE | CODE / COEFFICIENT

CC RU319CC 12,8

SS RU319SS 16,0

BO RU319BO 15,4

NP RU319NP 15,4

CF RU319CF 19,2

CS RU319CS 20,5

II RU319II 19,2

IS RU319IS 20,5

RS RU319RS 19,2

SR RU319SR 20,5

OO RU319OO 19,2

OS RU319OS 20,5

PACKAGING

L: 340 mm
D: 180 mm
H: 70 mm

3,1 kg

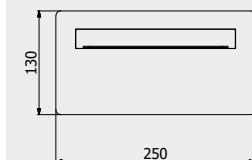

PORTATE | WATER FLOW | DÉBIT D'EAU

1 BAR 2 BAR 3 BAR
13 l/m 17,7 l/m 20 l/m

ARTICLE | ARTICOLO | ARTICLE

00320



Wall mounted spout

Bocca d'erogazione corta a parete

Bec de remplissage mural court

| CODICE / COEFFICIENTE | CODE / COEFFICIENT | COEFFICIENT |
|-----------------------|--------------------|-------------|
| CC | 00320CC | 7,1 |

PACKAGING

L: 150 mm
D: 190 mm
H: 98 mm

2,4 kg

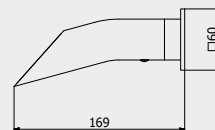

PORTATE | WATER FLOW | DÉBIT D'EAU

| 1 BAR | 2 BAR | 3 BAR |
|---------|---------|---------|
| 7,5 l/m | 8,5 l/m | 9,3 l/m |

ARTICLE | ARTICOLO | ARTICLE

00800



Shower column with mixer and shower kit

Colonna doccia con miscelatore e kit doccia

Colonne de douche avec mitigeur et kit douche

| CODICE / COEFFICIENTE | CODE / COEFFICIENT | COEFFICIENT |
|-----------------------|--------------------|-------------|
| CC | 00800CC | 52,5 |

PACKAGING

L: 1160 mm
D: 360 mm
H: 180 mm

14 kg

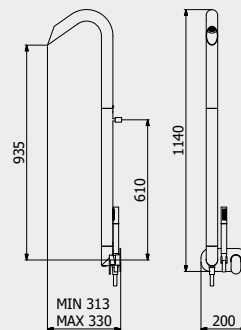

PORTATE | WATER FLOW | DÉBIT D'EAU

| 1 BAR | 2 BAR | 3 BAR |
|--------|--------|----------|
| 10 l/m | 15 l/m | 18,5 l/m |

Onlyone

ARTICLE | ARTICOLO | ARTICLE

00706



Exposed parts for bidet spray complete with mixer

Set di parti esterne per Idroscopino igienico con miscelatore

Partie extérieure pour douchette hygiénique avec mitigeur

| CODICE / COEFFICIENTE | CODE / COEFFICIENT | COEFFICIENT |
|-----------------------|--------------------|-------------|
| CC | EO0706CC | 9,8 |

PACKAGING

L: 370 mm
D: 270 mm
H: 80 mm

3,1 kg

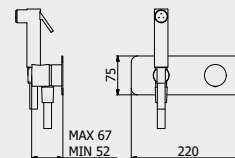

PORTATE | WATER FLOW | DÉBIT D'EAU

| 1 BAR | 2 BAR | 3 BAR |
|---------|---------|-------|
| 2,3 l/m | 3,2 l/m | 4 l/m |

Built-in body to be purchased separately

Corpo incasso da acquistare separatamente

Corps intégré à acheter séparément



CODICE | CODE | CODE

INC206XXXN_19

COEFFICIENTE | COEFFICIENT | COEFFICIENT

2,9



SNATCH / ACCESSORIES COLLECTION

ARTICLE | ARTICOLO | ARTICLE

HJ001

Wall soap-holder

Porta sapone a muro

Porte distributeur de savon encastré

CODICE / COEFFICIENTE | CODE /
COEFFICIENT | CODE / COEFFICIENT

| | | | |
|---|----|---------|-----|
| ☐ | CC | HJ001CC | 5,5 |
| ☐ | SS | HJ001SS | 5,7 |
| ☐ | BO | HJ001BO | 5,7 |
| ● | NP | HJ001NP | 5,7 |
| ● | CF | HJ001CF | 5,7 |
| ● | CS | HJ001CS | 5,7 |
| ● | II | HJ001II | 5,7 |
| ● | IS | HJ001IS | 5,7 |
| ● | RS | HJ001RS | 5,7 |
| ● | SR | HJ001SR | 5,7 |
| ● | OO | HJ001OO | 5,7 |
| ● | OS | HJ001OS | 5,7 |

PACKAGING

☐ L: 150 mm
D: 190 mm
H: 98 mm

☐ 0,4 kg

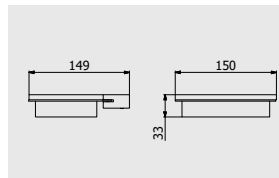

ARTICLE | ARTICOLO | ARTICLE

HJ003

Wall toothbrush holder

Porta spazzolino a muro

Porte brosse à dents encastré

CODICE / COEFFICIENTE | CODE /
COEFFICIENT | CODE / COEFFICIENT

| | | | |
|---|----|---------|-----|
| ☐ | CC | HJ003CC | 6,1 |
| ☐ | SS | HJ003SS | 6,3 |
| ☐ | BO | HJ003BO | 6,3 |
| ● | NP | HJ003NP | 6,3 |
| ● | CF | HJ003CF | 6,3 |
| ● | CS | HJ003CS | 6,3 |
| ● | II | HJ003II | 6,3 |
| ● | IS | HJ003IS | 6,3 |
| ● | RS | HJ003RS | 6,3 |
| ● | SR | HJ003SR | 6,3 |
| ● | OO | HJ003OO | 6,3 |
| ● | OS | HJ003OS | 6,3 |

PACKAGING

☐ L: 175 mm
D: 125 mm
H: 90 mm

☐ 0,2 kg

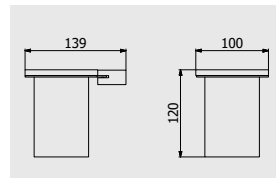

ARTICLE | ARTICOLO | ARTICLE

HJ016

Soap dispenser

Porta sapone da appoggio

Porte distributeur de savon

CODICE / COEFFICIENTE | CODE /
COEFFICIENT | CODE / COEFFICIENT

| | | | |
|---|----|---------|-----|
| ☐ | CC | HJ016CC | 2,2 |
| ☐ | SS | HJ016SS | 2,4 |
| ☐ | BO | HJ016BO | 2,4 |
| ● | NP | HJ016NP | 2,4 |
| ● | CF | HJ016CF | 2,4 |
| ● | CS | HJ016CS | 2,4 |
| ● | II | HJ016II | 2,4 |
| ● | IS | HJ016IS | 2,4 |
| ● | RS | HJ016RS | 2,4 |
| ● | SR | HJ016SR | 2,4 |
| ● | OO | HJ016OO | 2,4 |
| ● | OS | HJ016OS | 2,4 |

PACKAGING

☐ L: 150 mm
D: 190 mm
H: 98 mm

☐ 1,1 kg

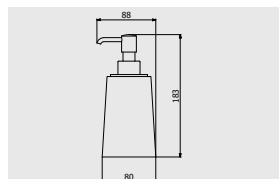

ARTICLE | ARTICOLO | ARTICLE

HJ017

Soap holder

Porta sapone da appoggio

Porte savon

CODICE / COEFFICIENTE | CODE /
COEFFICIENT | CODE / COEFFICIENT

| | | | |
|---|----|---------|-----|
| ☐ | CC | HJ017CC | 3,8 |
|---|----|---------|-----|

PACKAGING

☐ L: 175 mm
D: 125 mm
H: 90 mm

☐ 0,5 kg

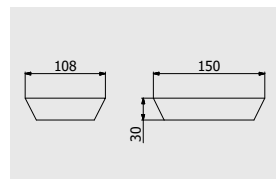

ARTICLE | ARTICOLO | ARTICLE

HJ010

Shelf
Mensola
Etagèr

CODICE / COEFFICIENTE | CODE / COEFFICIENT

| | | |
|----|---------|-----|
| CC | HJ010CC | 5,1 |
| SS | HJ010SS | 5,3 |
| BO | HJ010BO | 5,3 |
| NP | HJ010NP | 5,3 |
| CF | HJ010CF | 5,3 |
| CS | HJ010CS | 5,3 |
| II | HJ010II | 5,3 |
| IS | HJ010IS | 5,3 |
| RS | HJ010RS | 5,3 |
| SR | HJ010SR | 5,3 |
| OO | HJ010OO | 5,3 |
| OS | HJ010OS | 5,3 |

PACKAGING

| | | | |
|---|-----------|---|--------|
| 📦 | L: 175 mm | 📦 | 0,4 kg |
| | D: 125 mm | | |
| | H: 90 mm | | |

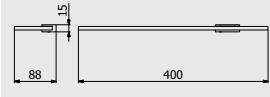

ARTICLE | ARTICOLO | ARTICLE

HJ011

Toilet paper holder
Porta rotolo
Porte rouleaux de toilette

CODICE / COEFFICIENTE | CODE / COEFFICIENT

| | | |
|----|---------|-----|
| CC | HJ011CC | 3,5 |
| SS | HJ011SS | 4,4 |
| BO | HJ011BO | 4,4 |
| NP | HJ011NP | 4,2 |
| CF | HJ011CF | 5,3 |
| CS | HJ011CS | 5,7 |
| II | HJ011II | 5,3 |
| IS | HJ011IS | 5,7 |
| RS | HJ011RS | 5,3 |
| SR | HJ011SR | 5,7 |
| OO | HJ011OO | 5,7 |
| OS | HJ011OS | 5,3 |

PACKAGING

| | | | |
|---|-----------|---|--------|
| 📦 | L: 150 mm | 📦 | 0,7 kg |
| | D: 100 mm | | |
| | H: 70 mm | | |

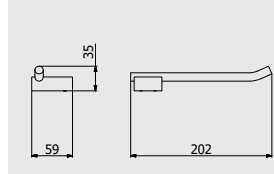

ARTICLE | ARTICOLO | ARTICLE

HJ009

Double robe hook
Doppio appendino a parete
Double cintre

CODICE / COEFFICIENTE | CODE / COEFFICIENT

| | | |
|----|---------|-----|
| CC | HJ009CC | 3,4 |
| SS | HJ009SS | 4,3 |
| BO | HJ009BO | 4,3 |
| NP | HJ009NP | 4,3 |
| CF | HJ009CF | 5,1 |
| CS | HJ009CS | 5,4 |
| II | HJ009II | 5,4 |
| IS | HJ009IS | 5,4 |
| RS | HJ009RS | 5,1 |
| SR | HJ009SR | 5,4 |
| OO | HJ009OO | 5,1 |
| OS | HJ009OS | 5,4 |

PACKAGING

| | | | |
|---|-----------|---|--------|
| 📦 | L: 150 mm | 📦 | 0,4 kg |
| | D: 100 mm | | |
| | H: 70 mm | | |

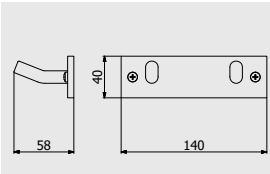

ARTICLE | ARTICOLO | ARTICLE

HJ004

Towel holder
Porta salvietta
Porte-serviette

CODICE / COEFFICIENTE | CODE / COEFFICIENT

| | | |
|----|---------|------|
| CC | HJ004CC | 7,5 |
| SS | HJ004SS | 9,4 |
| BO | HJ004BO | 9,4 |
| NP | HJ004NP | 9,4 |
| CF | HJ004CF | 11,3 |
| CS | HJ004CS | 12,0 |
| II | HJ004II | 11,3 |
| IS | HJ004IS | 12,0 |
| RS | HJ004RS | 11,3 |
| SR | HJ004SR | 12,0 |
| OO | HJ004OO | 11,3 |
| OS | HJ004OS | 12,0 |

PACKAGING

| | | | |
|---|-----------|---|--------|
| 📦 | L: 782 mm | 📦 | 1,9 kg |
| | D: 135 mm | | |
| | H: 80 mm | | |

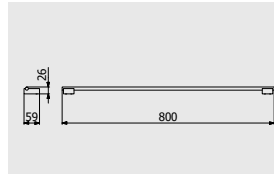

ARTICLE | ARTICOLO | ARTICLE

HJ014

Towel holder
Porta salvietta
Porte-serviette

CODICE / COEFFICIENTE | CODE / COEFFICIENT

| | | |
|----|---------|-----|
| CC | HJ014CC | 5,1 |
| SS | HJ014SS | 6,4 |
| BO | HJ014BO | 6,4 |
| NP | HJ014NP | 6,4 |
| CF | HJ014CF | 7,7 |
| CS | HJ014CS | 8,2 |
| II | HJ014II | 7,7 |
| IS | HJ014IS | 8,2 |
| RS | HJ014RS | 7,7 |
| SR | HJ014SR | 8,2 |
| OO | HJ014OO | 7,7 |
| OS | HJ014OS | 8,2 |

PACKAGING

| | | | |
|---|-----------|---|--------|
| 📦 | L: 100 mm | 📦 | 1,1 kg |
| | D: 100 mm | | |
| | H: 50 mm | | |

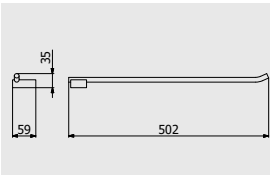

ARTICLE | ARTICOLO | ARTICLE

HJ006

Towel holder
Porta salvietta
Porte-serviette

CODICE / COEFFICIENTE | CODE / COEFFICIENT

| | | |
|----|---------|-----|
| CC | HJ006CC | 4,9 |
| SS | HJ006SS | 6,1 |
| BO | HJ006BO | 6,1 |
| NP | HJ006NP | 6,1 |
| CF | HJ006CF | 7,4 |
| CS | HJ006CS | 7,8 |
| II | HJ006II | 7,4 |
| IS | HJ006IS | 7,8 |
| RS | HJ006RS | 7,4 |
| SR | HJ006SR | 7,8 |
| OO | HJ006OO | 7,4 |
| OS | HJ006OS | 7,8 |

PACKAGING

| | | | |
|---|-----------|---|--------|
| 📦 | L: 175 mm | 📦 | 0,9 kg |
| | D: 125 mm | | |
| | H: 90 mm | | |

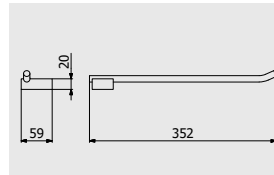

Onlyone

ARTICLE | ARTICOLO | ARTICLE

HJ007

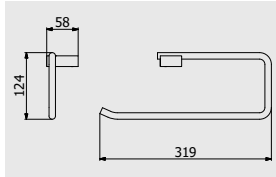

Ring Towel holder

Porta salvietta ad anello

Porte-serviette anneau

CODICE / COEFFICIENTE | CODE /
COEFFICIENT | CODE / COEFFICIENT

| | | |
|----|---------|-----|
| CC | HJ007CC | 5,0 |
| SS | HJ007SS | 6,3 |
| BO | HJ007BO | 6,3 |
| NP | HJ007NP | 6,3 |
| CF | HJ007CF | 7,5 |
| CS | HJ007CS | 8,0 |
| II | HJ007II | 7,5 |
| IS | HJ007IS | 8,0 |
| RS | HJ007RS | 7,5 |
| SR | HJ007SR | 8,0 |
| OO | HJ007OO | 7,5 |
| OS | HJ007OS | 8,0 |

PACKAGING

| | | | |
|---|-----------|---|--------|
| 📦 | L: 340 mm | 📦 | 1,9 kg |
| | D: 180 mm | | |
| | H: 70 mm | | |

ARTICLE | ARTICOLO | ARTICLE

HJ012

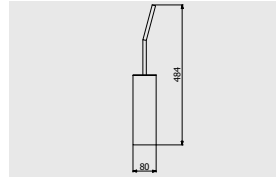

Toilet brush holder

Porta scopino da terra

Porte balayette au sol

CODICE / COEFFICIENTE | CODE /
COEFFICIENT | CODE / COEFFICIENT

| | | |
|----|---------|------|
| CC | HJ012CC | 7,8 |
| SS | HJ012SS | 9,8 |
| BO | HJ012BO | 9,8 |
| NP | HJ012NP | 9,8 |
| CF | HJ012CF | 11,7 |
| CS | HJ012CS | 12,5 |
| II | HJ012II | 11,7 |
| IS | HJ012IS | 12,5 |
| RS | HJ012RS | 11,7 |
| SR | HJ012SR | 12,5 |
| OO | HJ012OO | 11,7 |
| OS | HJ012OS | 12,5 |

PACKAGING

| | | | |
|---|-----------|---|--------|
| 📦 | L: 100 mm | 📦 | 1,8 kg |
| | D: 100 mm | | |
| | H: 50 mm | | |

ARTICLE | ARTICOLO | ARTICLE

HJ015

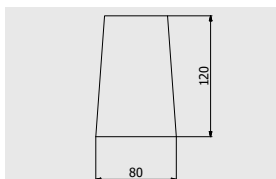

Toothbrush holder

Porta spazzolino

Porte brosse à dents

CODICE / COEFFICIENTE | CODE /
COEFFICIENT | CODE / COEFFICIENT

| | | |
|----|---------|-----|
| CC | HJ015CC | 2,8 |
|----|---------|-----|

PACKAGING

| | | | |
|---|-----------|---|--------|
| 📦 | L: 175 mm | 📦 | 0,6 kg |
| | D: 125 mm | | |
| | H: 90 mm | | |

ARTICLE | ARTICOLO | ARTICLE

HJ018

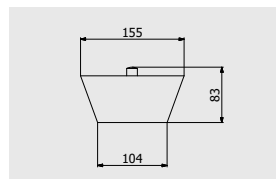

Box

Scatola

Boîte

CODICE / COEFFICIENTE | CODE /
COEFFICIENT | CODE / COEFFICIENT

| | | |
|----|---------|-----|
| CC | HJ018CC | 4,1 |
| SS | HJ018SS | 4,3 |
| BO | HJ018BO | 4,3 |
| NP | HJ018NP | 4,3 |
| CF | HJ018CF | 4,3 |
| CS | HJ018CS | 4,3 |
| II | HJ018II | 4,3 |
| IS | HJ018IS | 4,3 |
| RS | HJ018RS | 4,3 |
| SR | HJ018SR | 4,3 |
| OO | HJ018OO | 4,3 |
| OS | HJ018OS | 4,3 |

PACKAGING

| | | | |
|---|-----------|---|--------|
| 📦 | L: 240 mm | 📦 | 1,2 kg |
| | D: 215 mm | | |
| | H: 110 mm | | |





RUBACUORI

The sober lines of the square give shape to full and empty volumes.

Le sobrie linee del quadrato danno forma a volumi pieni e vuoti.
Les lignes sobres du carré façonnent des volumes pleins et vides.

A sober and essential line, suitable for modern bathrooms with a strong character. RUBACUORI is able to seduce everyone with its geometric shapes, always in vogue. In addition to the traditional lever, cohesive with the clean forms of the body, two other levers are also available: Bark, which breaks the square lines by adding a small rounded concavity at the end of the lever, and Dr. Jekyll, lighter and more lively, defined only by its outlines.

Una linea sobria ed essenziale, adatta a bagni moderni dal carattere deciso. RUBACUORI è il rubinetto capace di conquistare tutti con le sue forme geometriche sempre in voga. Oltre alla leva tradizionale, coesa alle forme pure del corpo, sono anche disponibili le leve Bark, che rompe le linee squadrate tramite l'aggiunta all'estremità di una piccola insenatura dalla forma arrotondata, e Dr. Jekyll, più leggera e vivace, definita dai soli contorni.

Une ligne sobre et essentielle, adaptée aux salles de bain modernes au caractère résolu. RUBACUORI est le robinet capable de conquérir tout le monde avec ses formes géométriques toujours en vogue. Par delà du levier traditionnel, cohérent avec les formes pures du corps, sont également disponibles les leviers Bark, qui rompt avec les lignes carrées en ajoutant à l'extrémité une petite anse arrondie, et Dr. Jekyll, plus léger et vif, défini seulement par ses contours.



CRYSTAL CLEAR
WATER



TRIPLE LEVERS



LEAD FREE



ZINC FREE





Rubacuori

DESIGN
ANDREA + DAVIDE BREGOLI



- ← DJ200CC
Monohole washbasin mixer
Miscelatore lavabo monoforo
Mitigeur lavabo
- ↓ BK200CC
Monohole washbasin mixer
Miscelatore lavabo monoforo
Mitigeur lavabo
- RU202CC
Tall monohole washbasin mixer
Miscelatore lavabo monoforo alto
Mitigeur lavabo haut









Rubacuori

← RU299CC
Monohole free-standing washbasin mixer
Miscelatore lavabo da terra
Mitigeur Lavabo Free standing

↑ RU206CC
Wall mounted washbasin mixer
Miscelatore lavabo due fori a parete
Mitigeur lavabo mural

→ RU200CC
Monohole washbasin mixer
Miscelatore lavabo monoforo
Mitigeur lavabo







Rubacuori

↑ DJ206CC
Wall mounted washbasin mixer
Miscelatore lavabo due fori a parete
Mitigeur lavabo mural

← RU201CC
Mini monohole washbasin mixer
Miscelatore lavabo monoforo mini
Mitigeur lavabo mini





Rubacuori

← DJ350CC
Wall mounted shower mixer with shower kit
Doccia esterno a parete con di kit doccia
Mitigeur de douche externe avec flexible et
douchette

↗ RU706CC
Exposed parts for bidet spray
Set di parti esterne per Idroscopino igienico
con miscelatore
Partie extérieure pour douchette hygiénique
avec mitigeur



← **RU314CC**

Three ways wall shower mixer complete with shower kit

Miscelatore doccia a parete con deviatore tre vie e doccino integrato

Mitigeur douche mural trois voies avec inverseur et douchette encastrée

→ **RU250CC**

Wall mounted bath filler complete with hand shower kit

Bordo vasca esterno a parete completo di kit doccia

Mitigeur Bain/douche Mural avec douchette encastrée



LEVER | LEVA | LEVIER



ARTICLE | ARTICOLO | ARTICLE

RU200 / BK200 / DJ200



Monohole washbasin mixer complete with drain

Miscelatore lavabo monoforo completo di scarico automatico

Mitigeur lavabo complet avec bonde automatique

CODE / COEFFICIENT | CODICE / COEFFICIENTE | CODE / COEFFICIENT

| | CC | RU200CC | BK200CC | DJ200CC | 7,6 |
|--|----|---------|---------|---------|------|
| | SS | RU200SS | BK200SS | DJ200SS | 9,5 |
| | BO | RU200BO | BK200BO | DJ200BO | 9,1 |
| | NP | RU200NP | BK200NP | DJ200NP | 9,1 |
| | CF | RU200CF | BK200CF | DJ200CF | 11,4 |
| | CS | RU200CS | BK200CS | DJ200CS | 12,2 |
| | II | RU200II | BK200II | DJ200II | 11,4 |
| | IS | RU200IS | BK200IS | DJ200IS | 12,2 |
| | RS | RU200RS | BK200RS | DJ200RS | 11,4 |
| | SR | RU200SR | BK200SR | DJ200SR | 12,2 |
| | OO | RU200OO | BK200OO | DJ200OO | 11,4 |
| | OS | RU200OS | BK200OS | DJ200OS | 12,2 |

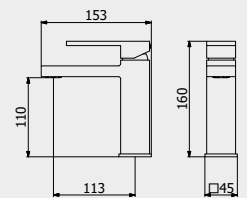

PORTATE | WATER FLOW | DÉBIT D'EAU

| 1 BAR | 2 BAR | 3 BAR |
|-------|---------|--------|
| 7 l/m | 9,5 l/m | 12 l/m |

PACKAGING

| | | | |
|--|------------------------------------|--|--------|
| | L: 340 mm D: 180 mm H: 70 mm | | 2,2 kg |
|--|------------------------------------|--|--------|

ARTICLE | ARTICOLO | ARTICLE

RU201



Mini monohole washbasin mixer complete with drain

Miscelatore lavabo monoforo mini completo di scarico automatico

Mitigeur lavabo mini complet avec bonde automatique

CODE / COEFFICIENT | CODICE / COEFFICIENTE | CODE / COEFFICIENT

| | | | |
|--|----|---------|------|
| | CC | RU201CC | 6,4 |
| | SS | RU201SS | 8,0 |
| | BO | RU201BO | 7,7 |
| | NP | RU201NP | 7,7 |
| | CF | RU201CF | 9,6 |
| | CS | RU201CS | 10,2 |
| | II | RU201II | 9,6 |
| | IS | RU201IS | 10,2 |
| | RS | RU201RS | 9,6 |
| | SR | RU201SR | 10,2 |
| | OO | RU201OO | 9,6 |
| | OS | RU201OS | 10,2 |

PACKAGING

| | | | |
|--|------------------------------------|--|--------|
| | L: 340 mm D: 180 mm H: 70 mm | | 1,8 kg |
|--|------------------------------------|--|--------|

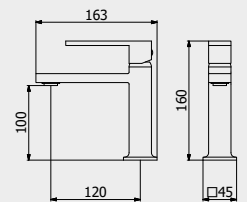

PORTATE | WATER FLOW | DÉBIT D'EAU

| 1 BAR | 2 BAR | 3 BAR |
|-------|---------|--------|
| 7 l/m | 9,5 l/m | 12 l/m |

PACKAGING

| | | | |
|--|------------------------------------|--|--------|
| | L: 425 mm D: 188 mm H: 98 mm | | 3,1 kg |
|--|------------------------------------|--|--------|

ARTICLE | ARTICOLO | ARTICLE

RU202 / BK202 / DJ202



Tall monohole washbasin mixer complete with drain

Miscelatore lavabo monoforo alto completo di scarico automatico

Mitigeur lavabo haut complet avec bonde automatique

CODE / COEFFICIENT | CODICE / COEFFICIENTE | CODE / COEFFICIENT

| | CC | RU202CC | BK202CC | DJ202CC | 10,5 |
|--|----|---------|---------|---------|------|
| | SS | RU202SS | BK202SS | DJ202SS | 13,1 |
| | BO | RU202BO | BK202BO | DJ202BO | 12,6 |
| | NP | RU202NP | BK202NP | DJ202NP | 12,6 |
| | CF | RU202CF | BK202CF | DJ202CF | 15,8 |
| | CS | RU202CS | BK202CS | DJ202CS | 16,8 |
| | II | RU202II | BK202II | DJ202II | 15,8 |
| | IS | RU202IS | BK202IS | DJ202IS | 16,8 |
| | RS | RU202RS | BK202RS | DJ202RS | 15,8 |
| | SR | RU202SR | BK202SR | DJ202SR | 16,8 |
| | OO | RU202OO | BK202OO | DJ202OO | 15,8 |
| | OS | RU202OS | BK202OS | DJ202OS | 16,8 |

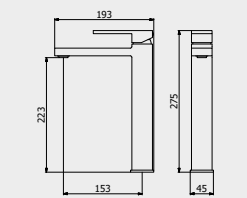

PORTATE | WATER FLOW | DÉBIT D'EAU

| 1 BAR | 2 BAR | 3 BAR |
|-------|---------|--------|
| 7 l/m | 9,5 l/m | 12 l/m |

PACKAGING

| | | | |
|--|------------------------------------|--|--------|
| | L: 425 mm D: 188 mm H: 98 mm | | 3,1 kg |
|--|------------------------------------|--|--------|



ARTICLE | ARTICOLO | ARTICLE

RU203



Tall mini monohole washbasin mixer complete with drain
 Miscelatore lavabo monoforo alto mini completo di scarico automatico
 Mitigeur lavabo haut mini complet avec bonde automatique

| CODE / COEFFICIENT CODICE / COEFFICIENTE CODE / COEFFICIENT | | |
|---|---------|------|
| CC | RU203CC | 8,7 |
| SS | RU203SS | 10,9 |
| BO | RU203BO | 10,4 |
| NP | RU203NP | 10,4 |
| CF | RU203CF | 13,1 |
| CS | RU203CS | 13,9 |
| II | RU203II | 13,1 |
| IS | RU203IS | 13,9 |
| RS | RU203RS | 13,1 |
| SR | RU203SR | 13,9 |
| OO | RU203OO | 13,1 |
| OS | RU203OS | 13,9 |

PACKAGING

L: 370 mm
 D: 270 mm
 H: 80 mm
 2,4 kg

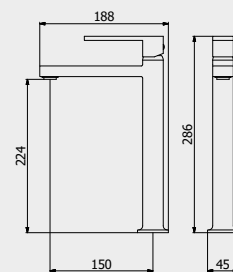

| PORTATE WATER FLOW DÉBIT D'EAU | | | |
|------------------------------------|---------|--------|--|
| 1 BAR | 2 BAR | 3 BAR | |
| 7 l/m | 9,5 l/m | 12 l/m | |

ARTICLE | ARTICOLO | ARTICLE

RU206 / BK206 / DJ206



Wall mounted washbasin mixer complete with drain
 Miscelatore lavabo due fori a parete completo di scarico automatico
 Mitigeur lavabo Mural complet avec bonde automatique

CODE / COEFFICIENT | CODICE / COEFFICIENTE | CODE / COEFFICIENT

| CODE / COEFFICIENT CODICE / COEFFICIENTE CODE / COEFFICIENT | | | | |
|---|----------|----------|----------|------|
| CC | ERU206CC | EBK206CC | EDJ206CC | 8,8 |
| SS | ERU206SS | EBK206SS | EDJ206SS | 11,0 |
| BO | ERU206BO | EBK206BO | EDJ206BO | 10,6 |
| NP | ERU206NP | EBK206NP | EDJ206NP | 10,6 |
| CF | ERU206CF | EBK206CF | EDJ206CF | 13,2 |
| CS | ERU206CS | EBK206CS | EDJ206CS | 14,1 |
| II | ERU206II | EBK206II | EDJ206II | 13,2 |
| IS | ERU206IS | EBK206IS | EDJ206IS | 14,1 |
| RS | ERU206RS | EBK206RS | EDJ206RS | 13,2 |
| SR | ERU206SR | EBK206SR | EDJ206SR | 14,1 |
| OO | ERU206OO | EBK206OO | EDJ206OO | 13,2 |
| OS | ERU206OS | EBK206OS | EDJ206OS | 14,1 |

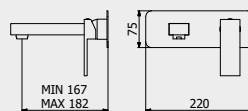

| PORTATE WATER FLOW DÉBIT D'EAU | | | |
|------------------------------------|----------|----------|--|
| 1 BAR | 2 BAR | 3 BAR | |
| 8,8 l/m | 12,3 l/m | 15,2 l/m | |

PACKAGING

L: 265 mm
 D: 260 mm
 H: 70 mm
 1,7 kg

Rubacuori

Built-in body to be purchased separately

Corpo incasso da acquistare separatamente

Corps intégré à acheter séparément



CODICE | CODE | CODE

INC206XXXN_19

COEFFICIENTE | COEFFICIENT | COEFFICIENT

2,9



ARTICLE | ARTICOLO | ARTICLE

RU207 / BK207 / DJ207



Wall mounted washbasin mixer with long spout complete with drain
 Miscelatore lavabo due fori a parete completo di scarico automatico
 Mitigeur lavabo Mural complet avec bonde automatique

CODE / COEFFICIENT | CODICE / COEFFICIENTE | CODE / COEFFICIENT

| CODE / COEFFICIENT CODICE / COEFFICIENTE CODE / COEFFICIENT | | | | |
|---|----------|----------|----------|------|
| CC | ERU207CC | EBK207CC | EDJ207CC | 9,6 |
| SS | ERU207SS | EBK207SS | EDJ207SS | 12,0 |
| BO | ERU207BO | EBK207BO | EDJ207BO | 11,5 |
| NP | ERU207NP | EBK207NP | EDJ207NP | 11,5 |
| CF | ERU207CF | EBK207CF | EDJ207CF | 14,4 |
| CS | ERU207CS | EBK207CS | EDJ207CS | 15,4 |
| II | ERU207II | EBK207II | EDJ207II | 14,4 |
| IS | ERU207IS | EBK207IS | EDJ207IS | 15,4 |
| RS | ERU207RS | EBK207RS | EDJ207RS | 14,4 |
| SR | ERU207SR | EBK207SR | EDJ207SR | 15,4 |
| OO | ERU207OO | EBK207OO | EDJ207OO | 14,4 |
| OS | ERU207OS | EBK207OS | EDJ207OS | 15,4 |

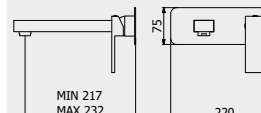

| PORTATE WATER FLOW DÉBIT D'EAU | | | |
|------------------------------------|----------|----------|--|
| 1 BAR | 2 BAR | 3 BAR | |
| 8,8 l/m | 12,3 l/m | 15,2 l/m | |

PACKAGING

L: 265 mm
 D: 260 mm
 H: 70 mm
 1,7 kg

Built-in body to be purchased separately

Corpo incasso da acquistare separatamente

Corps intégré à acheter séparément



CODICE | CODE | CODE

INC206XXXN_19

COEFFICIENTE | COEFFICIENT | COEFFICIENT

2,9



ARTICLE | ARTICOLO | ARTICLE

RU208 / BK208 / DJ208



Wall mounted washbasin mixer with long spout complete with drain
Miscelatore lavabo due fori a parete completo di scarico automatico
Mitigeur lavabo mural complet avec bonde automatique

CODE / COEFFICIENT | CODICE / COEFFICIENTE | CODE / COEFFICIENT



| | CC | SS | BO | NP | CF | CS | II | IS | RS | SR | OO | OS |
|--|----------|----------|----------|----------|----------|----------|----------|----------|----------|----------|----------|----------|
| | ERU208CC | ERU208SS | ERU208BO | ERU208NP | ERU208CF | ERU208CS | ERU208II | ERU208IS | ERU208RS | ERU208SR | ERU208OO | ERU208OS |
| | EBK208CC | EBK208SS | EBK208BO | EBK208NP | EBK208CF | EBK208CS | EBK208II | EBK208IS | EBK208RS | EBK208SR | EBK208OO | EBK208OS |
| | EDJ208CC | EDJ208SS | EDJ208BO | EDJ208NP | EDJ208CF | EDJ208CS | EDJ208II | EDJ208IS | EDJ208RS | EDJ208SR | EDJ208OO | EDJ208OS |
| | 9,6 | 12,0 | 11,5 | 11,5 | 14,4 | 15,4 | 14,4 | 15,4 | 14,4 | 15,4 | 14,4 | 15,4 |

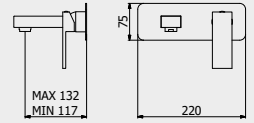

PORTATE | WATER FLOW | DÉBIT D'EAU

| 1 BAR | 2 BAR | 3 BAR |
|---------|----------|----------|
| 8,8 l/m | 12,3 l/m | 15,2 l/m |

PACKAGING

| | | | |
|--|------------------------------------|--|--------|
| | L: 265 mm D: 260 mm H: 70 mm | | 1,7 kg |
|--|------------------------------------|--|--------|

Built-in body to be purchased separately

Corpo incasso da acquistare separatamente

Corps intégré à acheter séparément



CODICE | CODE | CODE

INC206XXXN_19

COEFFICIENTE | COEFFICIENT | COEFFICIENT

2,9



ARTICLE | ARTICOLO | ARTICLE

RU210 / BK210 / DJ210



Ceiling spout with wall mounted mixer

Bocca da soffitto con comando remoto ad incasso

Mitigeur lavabo mural avec bec plafond complet avec bonde automatique

CODE / COEFFICIENT | CODICE / COEFFICIENTE | CODE / COEFFICIENT

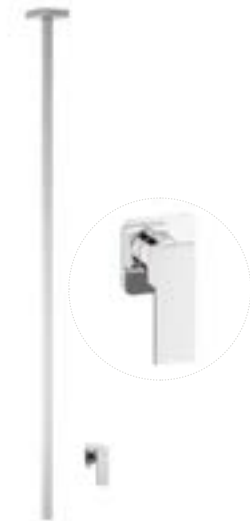

| | CC | SS | BO | NP |
|--|----------|----------|----------|----------|
| | ERU210CC | ERU210SS | ERU210BO | ERU210NP |
| | EBK210CC | EBK210SS | EBK210BO | EBK210NP |
| | EDJ210CC | EDJ210SS | EDJ210BO | EDJ210NP |
| | 33,8 | 42,3 | 40,6 | 40,6 |

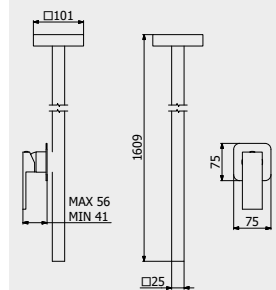

PORTATE | WATER FLOW | DÉBIT D'EAU

| 1 BAR | 2 BAR | 3 BAR |
|----------|---------|-------|
| 4,30 l/m | 5,2 l/m | 7 l/m |

PACKAGING

| | | | |
|--|------------------------------------|--|------------------------|
| | L: 150 mm D: 190 mm H: 98 mm | | L: 1700 mm Ø: 70 mm |
|--|------------------------------------|--|------------------------|

4,5 kg

Built-in body to be purchased separately

Corpo incasso da acquistare separatamente

Corps intégré à acheter séparément



CODICE | CODE | CODE

INC300XXXN_19

COEFFICIENTE | COEFFICIENT | COEFFICIENT

1,8



ARTICLE | ARTICOLO | ARTICLE

RU299 / BK299 / DJ299



Monohole free-standing washbasin mixer complete with drain
 Miscelatore lavabo da terra completo di scarico automatico
 Mitigeur lavabo free standing complet avec bonde automatique

CODE / COEFFICIENT | CODICE / COEFFICIENTE | CODE / COEFFICIENT

| | CC | SS | BO | NP | CF | CS | II | IS | RS | SR | OO | OS |
|--|-----------|-----------|-----------|-----------|-----------|-----------|-----------|-----------|-----------|-----------|-----------|-----------|
| | ERU299CC | ERU299SS | ERU299BO | ERU299NP | ERU299CF | ERU299CS | ERU299II | ERU299IS | ERU299RS | ERU299SR | ERU299OO | ERU299OS |
| | EBK299CC | EBK299SS | EBK299BO | EBK299NP | EBK299CF | EBK299CS | EBK299II | EBK299IS | EBK299RS | EBK299SR | EBK299OO | EBK299OS |
| | EEDJ299CC | EEDJ299SS | EEDJ299BO | EEDJ299NP | EEDJ299CF | EEDJ299CS | EEDJ299II | EEDJ299IS | EEDJ299RS | EEDJ299SR | EEDJ299OO | EEDJ299OS |
| | 35,5 | 44,4 | 42,6 | 42,6 | 53,3 | 53,3 | 53,3 | 56,8 | 53,3 | 56,8 | 53,3 | 56,8 |

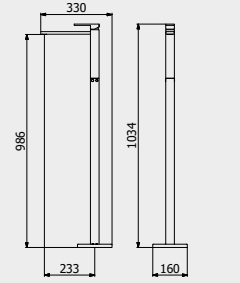

PORTATE | WATER FLOW | DÉBIT D'EAU

| 1 BAR | 2 BAR | 3 BAR |
|-------|---------|-------|
| 6 l/m | 7,5 l/m | 9 l/m |

PACKAGING

| | |
|------------|------------|
| L: 1160 mm | ⚖️ 13,1 kg |
| D: 360 mm | |
| H: 180 mm | |

Built-in body to be purchased separately
AVAILABLE FROM JANUARY 2020
 Corpo incasso da acquistare separatamente
DISPONIBILE DA GENNAIO 2020
 Corps intégré à acheter séparément
DISPONIBLE À PARTIR DE JANVIER 2020



CODICE | CODE | CODE

INC399XXXN_19

COEFFICIENTE | COEFFICIENT | COEFFICIENT

2,8

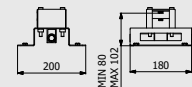

ARTICLE | ARTICOLO | ARTICLE

RU220 / BK220 / DJ220



Monohole bidet mixer complete with drain
 Miscelatore bidet monoforo completo di scarico automatico
 Mitigeur bidet complet avec bonde automatique

CODE / COEFFICIENT | CODICE / COEFFICIENTE | CODE / COEFFICIENT

| | CC | SS | BO | NP | CF | CS | II | IS | RS | SR | OO | OS |
|--|---------|---------|---------|---------|---------|---------|---------|---------|---------|---------|---------|---------|
| | RU220CC | RU220SS | RU220BO | RU220NP | RU220CF | RU220CS | RU220II | RU220IS | RU220RS | RU220SR | RU220OO | RU220OS |
| | BK220CC | BK220SS | BK220BO | BK220NP | BK220CF | BK220CS | BK220II | BK220IS | BK220RS | BK220SR | BK220OO | BK220OS |
| | DJ220CC | DJ220SS | DJ220BO | DJ220NP | DJ220CF | DJ220CS | DJ220II | DJ220IS | DJ220RS | DJ220SR | DJ220OO | DJ220OS |
| | 7,6 | 9,5 | 9,1 | 9,1 | 11,4 | 12,2 | 11,4 | 12,2 | 11,4 | 12,2 | 11,4 | 12,2 |

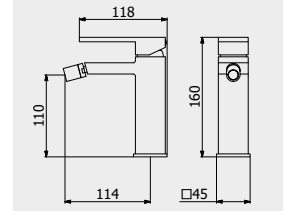

PORTATE | WATER FLOW | DÉBIT D'EAU

| 1 BAR | 2 BAR | 3 BAR |
|-------|---------|--------|
| 7 l/m | 9,5 l/m | 12 l/m |

PACKAGING

| | |
|-----------|-----------|
| L: 340 mm | ⚖️ 2,3 kg |
| D: 180 mm | |
| H: 70 mm | |

Rubacuori

ARTICLE | ARTICOLO | ARTICLE

RU223 / BK223 / DJ223



Mini monohole bidet mixer complete with drain
 Miscelatore bidet monoforo mini completo di scarico automatico
 Mitigeur bidet complet avec bonde automatique

CODE / COEFFICIENT | CODICE / COEFFICIENTE | CODE / COEFFICIENT

| | CC | SS | BO | NP | CF | CS | II | IS | RS | SR | OO | OS |
|--|---------|---------|---------|---------|---------|---------|---------|---------|---------|---------|---------|---------|
| | RU223CC | RU223SS | RU223BO | RU223NP | RU223CF | RU223CS | RU223II | RU223IS | RU223RS | RU223SR | RU223OO | RU223OS |
| | BK223CC | BK223SS | BK223BO | BK223NP | BK223CF | BK223CS | BK223II | BK223IS | BK223RS | BK223SR | BK223OO | BK223OS |
| | DJ223CC | DJ223SS | DJ223BO | DJ223NP | DJ223CF | DJ223CS | DJ223II | DJ223IS | DJ223RS | DJ223SR | DJ223OO | DJ223OS |
| | 6,4 | 8,0 | 7,7 | 7,7 | 9,6 | 10,2 | 9,6 | 10,2 | 9,6 | 10,2 | 9,6 | 10,2 |

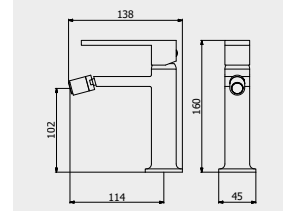

PORTATE | WATER FLOW | DÉBIT D'EAU

| 1 BAR | 2 BAR | 3 BAR |
|-------|---------|---------|
| 5 l/m | 7,1 l/m | 8,6 l/m |

PACKAGING

| | |
|-----------|-----------|
| L: 340 mm | ⚖️ 2,3 kg |
| D: 180 mm | |
| H: 70 mm | |

ARTICLE | ARTICOLO | ARTICLE

RU300 / BK300 / DJ300



Exposed parts for manual wall mixer

Set di parti esterne per miscelatore a parete ad una via

Partie extérieure pour mitigeur encastré à une voie

CODE / COEFFICIENT | CODICE / COEFFICIENTE | CODE / COEFFICIENT

| | CC | SS | BO | NP | CF | CS | II | IS | RS | SR | OO | OS |
|--|----------|----------|----------|----------|----------|----------|----------|----------|----------|----------|----------|----------|
| | ERU300CC | ERU300SS | ERU300BO | ERU300NP | ERU300CF | ERU300CS | ERU300II | ERU300IS | ERU300RS | ERU300SR | ERU300OO | ERU300OS |
| | EBK300CC | EBK300SS | EBK300BO | EBK300NP | EBK300CF | EBK300CS | EBK300II | EBK300IS | EBK300RS | EBK300SR | EBK300OO | EBK300OS |
| | EDJ300CC | EDJ300SS | EDJ300BO | EDJ300NP | EDJ300CF | EDJ300CS | EDJ300II | EDJ300IS | EDJ300RS | EDJ300SR | EDJ300OO | EDJ300OS |
| | 4,1 | 5,1 | 4,9 | 4,9 | 6,2 | 6,6 | 6,2 | 6,6 | 6,2 | 6,6 | 6,2 | 6,6 |

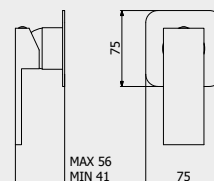

PORTATE | WATER FLOW | DÉBIT D'EAU

| 1 BAR | 2 BAR | 3 BAR |
|----------|----------|--------|
| 11,5 l/m | 16,3 l/m | 20 l/m |

PACKAGING

L: 150 mm
D: 190 mm
H: 98 mm

1,7 kg

Built-in body to be purchased separately

Corpo incasso da acquistare separatamente

Corps intégré à acheter séparément



CODICE | CODE | CODE

INC300XXXN_19

COEFFICIENTE | COEFFICIENT | COEFFICIENT

1,8



ARTICLE | ARTICOLO | ARTICLE

RU310 / BK310 / DJ310



Exposed parts for manual wall mixer with two ways diverter

Miscelatore doccia a parete con deviatore due vie

Mitigeur douche mural deux voies avec inverseur

CODE / COEFFICIENT | CODICE / COEFFICIENTE | CODE / COEFFICIENT

| | CC | SS | BO | NP | CF | CS | II | IS | RS | SR | OO | OS |
|--|----------|----------|----------|----------|----------|----------|----------|----------|----------|----------|----------|----------|
| | ERU310CC | ERU310SS | ERU310BO | ERU310NP | ERU310CF | ERU310CS | ERU310II | ERU310IS | ERU310RS | ERU310SR | ERU310OO | ERU310OS |
| | EBK310CC | EBK310SS | EBK310BO | EBK310NP | EBK310CF | EBK310CS | EBK310II | EBK310IS | EBK310RS | EBK310SR | EBK310OO | EBK310OS |
| | EDJ310CC | EDJ310SS | EDJ310BO | EDJ310NP | EDJ310CF | EDJ310CS | EDJ310II | EDJ310IS | EDJ310RS | EDJ310SR | EDJ310OO | EDJ310OS |
| | 6,1 | 7,6 | 7,3 | 7,3 | 9,2 | 9,8 | 9,2 | 9,8 | 9,2 | 9,8 | 9,2 | 9,8 |

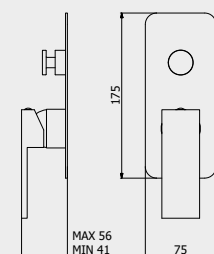

PORTATE | WATER FLOW | DÉBIT D'EAU

| 1 BAR | 2 BAR | 3 BAR |
|---------|----------|--------|
| 9,2 l/m | 12,8 l/m | 16 l/m |

PACKAGING

L: 150 mm
D: 190 mm
H: 98 mm

1,7 kg

Built-in body to be purchased separately

Corpo incasso da acquistare separatamente

Corps intégré à acheter séparément



CODICE | CODE | CODE

INC310XXXN_19

COEFFICIENTE | COEFFICIENT | COEFFICIENT

3,3

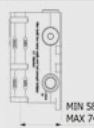

ARTICLE | ARTICOLO | ARTICLE

RU312 / BK312 / DJ312



Exposed parts for manual wall mixer with three ways diverter
Set di parti esterne per miscelatore a parete a tre vie
Mitigeur douche mural trois voies avec inverseur

CODE / COEFFICIENT | CODICE / COEFFICIENTE | CODE / COEFFICIENT

| | CC | ERU312CC | EBK312CC | EDJ312CC | 7,4 |
|--|----|----------|----------|----------|------|
| | SS | ERU312SS | EBK312SS | EDJ312SS | 9,3 |
| | BO | ERU312BO | EBK312BO | EDJ312BO | 8,9 |
| | NP | ERU312NP | EBK312NP | EDJ312NP | 8,9 |
| | CF | ERU312CF | EBK312CF | EDJ312CF | 11,1 |
| | CS | ERU312CS | EBK312CS | EDJ312CS | 11,8 |
| | II | ERU312II | EBK312II | EDJ312II | 11,1 |
| | IS | ERU312IS | EBK312IS | EDJ312IS | 11,8 |
| | RS | ERU312RS | EBK312RS | EDJ312RS | 11,1 |
| | SR | ERU312SR | EBK312SR | EDJ312SR | 11,8 |
| | OO | ERU312OO | EBK312OO | EDJ312OO | 11,1 |
| | OS | ERU312OS | EBK312OS | EDJ312OS | 11,8 |

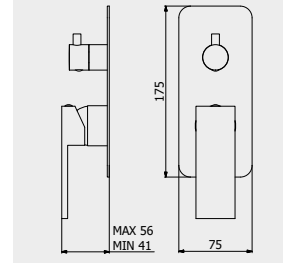

PORTATE | WATER FLOW | DÉBIT D'EAU

| 1 BAR | 2 BAR | 3 BAR |
|---------|----------|----------|
| 8,3 l/m | 11,7 l/m | 14,3 l/m |

PACKAGING

L: 150 mm
D: 190 mm
H: 98 mm 1,7 kg

Built-in body to be purchased separately

Corpo incasso da acquistare separatamente
Corps intégré à acheter séparément



CODICE | CODE | CODE

INC312XXXN_19

COEFFICIENTE | COEFFICIENT | COEFFICIENT

3,3

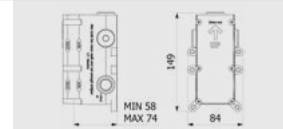

ARTICLE | ARTICOLO | ARTICLE

RU313 / BK313 / DJ313



Exposed parts for manual wall mixer with 2 ways with shower kit
Set di parti esterne per miscelatore a parete a due vie completo di kit doccia
Partie extérieure pour mitigeur encastré à deux voies avec douchette

CODE / COEFFICIENT | CODICE / COEFFICIENTE | CODE / COEFFICIENT

| | CC | ERU313CC | EBK313CC | EDJ313CC | 10,1 |
|--|----|----------|----------|----------|------|
| | SS | ERU313SS | EBK313SS | EDJ313SS | 12,6 |
| | BO | ERU313BO | EBK313BO | EDJ313BO | 12,1 |
| | NP | ERU313NP | EBK313NP | EDJ313NP | 12,1 |
| | CF | ERU313CF | EBK313CF | EDJ313CF | 15,2 |
| | CS | ERU313CS | EBK313CS | EDJ313CS | 16,2 |
| | II | ERU313II | EBK313II | EDJ313II | 15,2 |
| | IS | ERU313IS | EBK313IS | EDJ313IS | 16,2 |
| | RS | ERU313RS | EBK313RS | EDJ313RS | 15,2 |
| | SR | ERU313SR | EBK313SR | EDJ313SR | 16,2 |
| | OO | ERU313OO | EBK313OO | EDJ313OO | 15,2 |
| | OS | ERU313OS | EBK313OS | EDJ313OS | 16,2 |

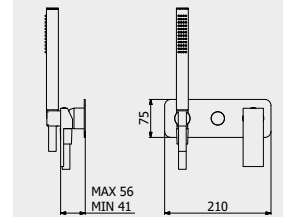

PORTATE | WATER FLOW | DÉBIT D'EAU

| 1 BAR | 2 BAR | 3 BAR |
|--------|----------|----------|
| 10 l/m | 14,1 l/m | 17,2 l/m |

PACKAGING

L: 370 mm
D: 270 mm
H: 98 mm 2,1 kg

Built-in body to be purchased separately

Corpo incasso da acquistare separatamente
Corps intégré à acheter séparément



CODICE | CODE | CODE

INC313XXXN_19

COEFFICIENTE | COEFFICIENT | COEFFICIENT

3,6

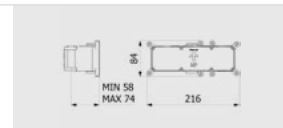

ARTICLE | ARTICOLO | ARTICLE

RU314 / BK314 / DJ314



Exposed parts for manual wall mixer with 3 ways with shower kit
Set di parti esterne per miscelatore a parete a tre vie completo di kit doccia
Partie extérieure pour mitigeur encastré à trois voies avec douchette

CODE / COEFFICIENT | CODICE / COEFFICIENTE | CODE / COEFFICIENT

| | CC | ERU314CC | EBK314CC | EDJ314CC | 11,4 |
|--|----|----------|----------|----------|------|
| | SS | ERU314SS | EBK314SS | EDJ314SS | 14,3 |
| | BO | ERU314BO | EBK314BO | EDJ314BO | 13,7 |
| | NP | ERU314NP | EBK314NP | EDJ314NP | 13,7 |
| | CF | ERU314CF | EBK314CF | EDJ314CF | 17,1 |
| | CS | ERU314CS | EBK314CS | EDJ314CS | 18,2 |
| | II | ERU314II | EBK314II | EDJ314II | 17,1 |
| | IS | ERU314IS | EBK314IS | EDJ314IS | 18,2 |
| | RS | ERU314RS | EBK314RS | EDJ314RS | 17,1 |
| | SR | ERU314SR | EBK314SR | EDJ314SR | 18,2 |
| | OO | ERU314OO | EBK314OO | EDJ314OO | 17,1 |
| | OS | ERU314OS | EBK314OS | EDJ314OS | 18,2 |

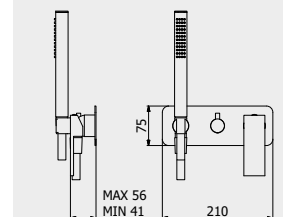

PORTATE | WATER FLOW | DÉBIT D'EAU

| 1 BAR | 2 BAR | 3 BAR |
|---------|----------|----------|
| 8,3 l/m | 11,7 l/m | 14,3 l/m |

PACKAGING

L: 370 mm
D: 270 mm
H: 98 mm 2,1 kg

Built-in body to be purchased separately

Corpo incasso da acquistare separatamente
Corps intégré à acheter séparément



CODICE | CODE | CODE

INC314XXXN_19

COEFFICIENTE | COEFFICIENT | COEFFICIENT

3,7

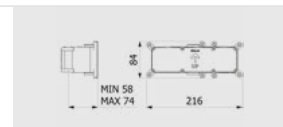

ARTICLE | ARTICOLO | ARTICLE

RU250 / BK250 / DJ250



Wall mounted bath filler complete with hand shower kit

Bordo vasca esterno a parete completo di kit doccia

Mitigeur Bain/douche Mural avec douchette encastrée

CODE / COEFFICIENT | CODICE / COEFFICIENTE | CODE / COEFFICIENT

| ● CC | RU250CC | BK250CC | DJ250CC | 14,4 |
|------|---------|---------|---------|------|
| ● SS | RU250SS | BK250SS | DJ250SS | 18,0 |
| ● BO | RU250BO | BK250BO | DJ250BO | 17,3 |
| ● NP | RU250NP | BK250NP | DJ250NP | 17,3 |
| ● CF | RU250CF | BK250CF | DJ250CF | 21,6 |
| ● CS | RU250CS | BK250CS | DJ250CS | 23 |
| ● II | RU250II | BK250II | DJ250II | 21,6 |
| ● IS | RU250IS | BK250IS | DJ250IS | 23 |
| ● RS | RU250RS | BK250RS | DJ250RS | 21,6 |
| ● SR | RU250SR | BK250SR | DJ250SR | 23 |
| ● OO | RU250OO | BK250OO | DJ250OO | 21,6 |
| ● OS | RU250OS | BK250OS | DJ250OS | 23 |

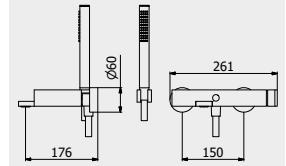

PORTATE | WATER FLOW | DÉBIT D'EAU

| 1 BAR | 2 BAR | 3 BAR |
|--------|--------|--------|
| 10 l/m | 14 l/m | 17 l/m |

PACKAGING

L: 270 mm
D: 270 mm
H: 80 mm

4,6 kg

ARTICLE | ARTICOLO | ARTICLE

RU350 / BK350 / DJ350



Wall mounted shower mixer with shower kit

Doccia esterno a parete completo di kit doccia

Mitigeur de douche externe avec flexible et douchette

CODE / COEFFICIENT | CODICE / COEFFICIENTE | CODE / COEFFICIENT

| ● CC | RU350CC | BK350CC | DJ350CC | 13,7 |
|------|---------|---------|---------|------|
| ● SS | RU350SS | BK350SS | DJ350SS | 17,1 |
| ● BO | RU350BO | BK350BO | DJ350BO | 16,4 |
| ● NP | RU350NP | BK350NP | DJ350NP | 16,4 |
| ● CF | RU350CF | BK350CF | DJ350CF | 20,6 |
| ● CS | RU350CS | BK350CS | DJ350CS | 21,9 |
| ● II | RU350II | BK350II | DJ350II | 20,6 |
| ● IS | RU350IS | BK350IS | DJ350IS | 21,9 |
| ● RS | RU350RS | BK350RS | DJ350RS | 20,6 |
| ● SR | RU350SR | BK350SR | DJ350SR | 21,9 |
| ● OO | RU350OO | BK350OO | DJ350OO | 20,6 |
| ● OS | RU350OS | BK350OS | DJ350OS | 21,9 |

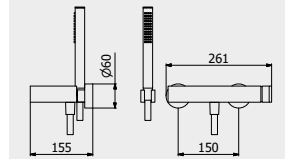

PORTATE | WATER FLOW | DÉBIT D'EAU

| 1 BAR | 2 BAR | 3 BAR |
|--------|--------|--------|
| 12 l/m | 17 l/m | 22 l/m |

PACKAGING

L: 370 mm
D: 270 mm
H: 80 mm

4,2 kg

ARTICLE | ARTICOLO | ARTICLE

RU399 / BK399 / DJ399



Free-standing bath filler with shower kit

Bordo vasca da terra con kit doccia

Bain douche complet alimentation au sol

CODE / COEFFICIENT | CODICE / COEFFICIENTE | CODE / COEFFICIENT

| ● CC | ERU399CC | EBK399CC | EDJ399CC | 26,3 |
|------|----------|----------|----------|------|
| ● SS | ERU399SS | EBK399SS | EDJ399SS | 32,9 |
| ● BO | ERU399BO | EBK399BO | EDJ399BO | 31,6 |
| ● NP | ERU399NP | EBK399NP | EDJ399NP | 31,6 |
| ● CF | ERU399CF | EBK399CF | EDJ399CF | 39,5 |
| ● CS | ERU399CS | EBK399CS | EDJ399CS | 42,1 |
| ● II | ERU399II | EBK399II | EDJ399II | 39,5 |
| ● IS | ERU399IS | EBK399IS | EDJ399IS | 42,1 |
| ● RS | ERU399RS | EBK399RS | EDJ399RS | 39,5 |
| ● SR | ERU399SR | EBK399SR | EDJ399SR | 42,1 |
| ● OO | ERU399OO | EBK399OO | EDJ399OO | 39,5 |
| ● OS | ERU399OS | EBK399OS | EDJ399OS | 42,1 |

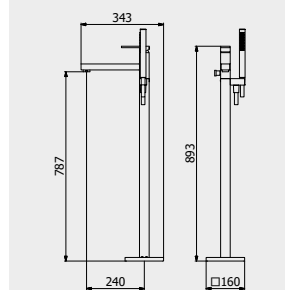

PORTATE | WATER FLOW | DÉBIT D'EAU

| 1 BAR | 2 BAR | 3 BAR |
|--------|--------|--------|
| 12 l/m | 17 l/m | 21 l/m |

PACKAGING

L: 1110 mm
D: 400 mm
H: 170 mm

14 kg

Built-in body to be purchased separately
AVAILABLE FROM JANUARY 2020

Corpo incasso da acquistare separatamente
DISPONIBILE DA GENNAIO 2020

Corps intégré à acheter séparément
DISPONIBLE À PARTIR DE JANVIER 2020



CODICE | CODE | CODE

INC399XXXN_19

COEFFICIENTE | COEFFICIENT | COEFFICIENT

2,8

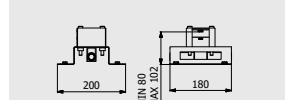

ARTICLE | ARTICOLO | ARTICLE

RU318



Built-in wall mounted waterfall spout
 Cascata a parete con erogazione a lama esterna
 Cascade murale avec bec externe



| CODE / COEFFICIENT | CODICE / COEFFICIENTE | |
|--------------------|-----------------------|------|
| CC | RU318CC | 22,9 |
| SS | RU318SS | 28,6 |
| BO | RU318BO | 27,5 |
| NP | RU318NP | 27,5 |
| CF | RU318CF | 34,4 |
| CS | RU318CS | 36,6 |
| II | RU318II | 34,4 |
| IS | RU318IS | 36,6 |
| RS | RU318RS | 34,4 |
| SR | RU318SR | 36,6 |
| OO | RU318OO | 34,4 |
| OS | RU318OS | 36,6 |

PACKAGING

L: 340 mm
 D: 180 mm
 H: 70 mm
 4,0 kg

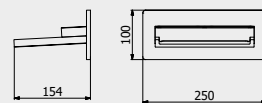

PORTATE | WATER FLOW | DÉBIT D'EAU

| | | |
|--------|--------|--------|
| 1 BAR | 2 BAR | 3 BAR |
| 13 l/m | 17 l/m | 20 l/m |

ARTICLE | ARTICOLO | ARTICLE

RU319



Wall mounted waterfall
 Cascata a parete con erogazione diretta
 Cascade murale



| CODE / COEFFICIENT | CODICE / COEFFICIENTE | |
|--------------------|-----------------------|------|
| CC | RU319CC | 12,8 |
| SS | RU319SS | 16,0 |
| BO | RU319BO | 15,4 |
| NP | RU319NP | 15,4 |
| CF | RU319CF | 19,2 |
| CS | RU319CS | 20,5 |
| II | RU319II | 19,2 |
| IS | RU319IS | 20,5 |
| RS | RU319RS | 19,2 |
| SR | RU319SR | 20,5 |
| OO | RU319OO | 19,2 |
| OS | RU319OS | 20,5 |

PACKAGING

L: 340 mm
 D: 180 mm
 H: 70 mm
 3,1 kg

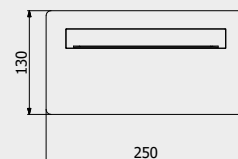

PORTATE | WATER FLOW | DÉBIT D'EAU

| | | |
|--------|--------|--------|
| 1 BAR | 2 BAR | 3 BAR |
| 13 l/m | 17 l/m | 20 l/m |

Rubacuori

ARTICLE | ARTICOLO | ARTICLE

RU320



Wall mounted spout
 Bocca d'erogazione a parete
 Bec de remplissage mural



| CODE / COEFFICIENT | CODICE / COEFFICIENTE | |
|--------------------|-----------------------|-----|
| CC | RU320CC | 2,1 |
| SS | RU320SS | 2,6 |
| BO | RU320BO | 2,5 |
| NP | RU320NP | 2,5 |
| CF | RU320CF | 3,2 |
| CS | RU320CS | 3,4 |
| II | RU320II | 3,2 |
| IS | RU320IS | 3,4 |
| RS | RU320RS | 3,2 |
| SR | RU320SR | 3,4 |
| OO | RU320OO | 3,2 |
| OS | RU320OS | 3,4 |

PACKAGING

L: 210 mm
 D: 130 mm
 H: 70 mm
 1,1 kg

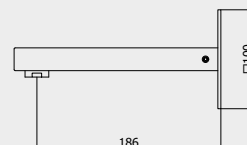

PORTATE | WATER FLOW | DÉBIT D'EAU

| | | |
|--------|--------|--------|
| 1 BAR | 2 BAR | 3 BAR |
| 10 l/m | 14 l/m | 17 l/m |

ARTICLE | ARTICOLO | ARTICLE

RU321



Short wall mounted spout
 Bocca d'erogazione corta a parete
 Bec de remplissage mural court



| CODE / COEFFICIENT | CODICE / COEFFICIENTE | |
|--------------------|-----------------------|-----|
| CC | RU321CC | 2,5 |
| SS | RU321SS | 3,1 |
| BO | RU321BO | 3,0 |
| NP | RU321NP | 3,0 |
| CF | RU321CF | 3,8 |
| CS | RU321CS | 4,0 |
| II | RU321II | 3,8 |
| IS | RU321IS | 4,0 |
| RS | RU321RS | 3,8 |
| SR | RU321SR | 4,0 |
| OO | RU321OO | 3,8 |
| OS | RU321OS | 4,0 |

PACKAGING

L: 210 mm
 D: 130 mm
 H: 70 mm
 1,0 kg

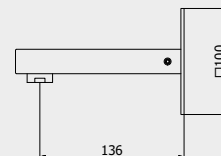

PORTATE | WATER FLOW | DÉBIT D'EAU

| | | |
|--------|--------|--------|
| 1 BAR | 2 BAR | 3 BAR |
| 10 l/m | 14 l/m | 17 l/m |

ARTICLE | ARTICOLO | ARTICLE

RU322



Long wall mounted spout

Bocca d'erogazione lunga a parete

Bec de remplissage mural long

CODE / COEFFICIENT | CODICE /
COEFFICIENTE | CODE / COEFFICIENT

| | | |
|------|---------|-----|
| ● CC | RU322CC | 3,0 |
| ● SS | RU322SS | 3,8 |
| ● BO | RU322BO | 3,6 |
| ● NP | RU322NP | 3,6 |
| ● CF | RU322CF | 4,5 |
| ● CS | RU322CS | 4,8 |
| ● II | RU322II | 4,5 |
| ● IS | RU322IS | 4,8 |
| ● RS | RU322RS | 4,5 |
| ● SR | RU322SR | 4,8 |
| ● OO | RU322OO | 4,5 |
| ● OS | RU322OS | 4,8 |

PACKAGING

L: 210 mm
D: 130 mm
H: 70 mm

1,2 kg



PORTATE | WATER FLOW | DÉBIT D'EAU

| | | |
|--------|--------|--------|
| 1 BAR | 2 BAR | 3 BAR |
| 10 l/m | 14 l/m | 17 l/m |

ARTICLE | ARTICOLO | ARTICLE

RU800



Rubacuori shower column

Colonna doccia Rubacuori

Colonne de douche Rubacuori

CODE / COEFFICIENT | CODICE /
COEFFICIENTE | CODE / COEFFICIENT

| | | |
|------|---------|------|
| ● CC | RU800CC | 29,4 |
|------|---------|------|

PACKAGING

L: 1185 mm
D: 415 mm
H: 277 mm

4 kg

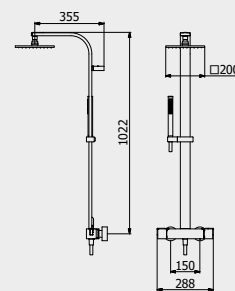

PORTATE | WATER FLOW | DÉBIT D'EAU

| | | |
|---------|---------|----------|
| 1 BAR | 2 BAR | 3 BAR |
| 6,5 l/m | 9,7 l/m | 12,1 l/m |

ARTICLE | ARTICOLO | ARTICLE

RU706



Exposed parts for bidet spray complete with mixer

Set di parti esterne per Idroscopino igienico con miscelatore

Partie extérieure pour douchette hygiénique avec mitigeur

CODE / COEFFICIENT | CODICE / COEFFICIENTE | CODE / COEFFICIENT

| | | | | |
|------|----------|----------|----------|------|
| ● CC | ERU706CC | EBK706CC | EDJ706CC | 9,8 |
| ● SS | ERU706SS | EBK706SS | EDJ706SS | 12,3 |
| ● BO | ERU706BO | EBK706BO | EDJ706BO | 11,8 |
| ● NP | ERU706NP | EBK706NP | EDJ706NP | 11,8 |
| ● CF | ERU706CF | EBK706CF | EDJ706CF | 14,7 |
| ● CS | ERU706CS | EBK706CS | EDJ706CS | 15,7 |
| ● II | ERU706II | EBK706II | EDJ706II | 14,7 |
| ● IS | ERU706IS | EBK706IS | EDJ706IS | 15,7 |
| ● RS | ERU706RS | EBK706RS | EDJ706RS | 14,7 |
| ● SR | ERU706SR | EBK706SR | EDJ706SR | 15,7 |
| ● OO | ERU706OO | EBK706OO | EDJ706OO | 14,7 |
| ● OS | ERU706OS | EBK706OS | EDJ706OS | 15,7 |

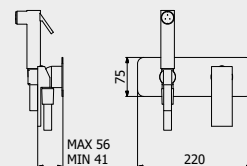

PORTATE | WATER FLOW | DÉBIT D'EAU

| | | |
|---------|---------|-------|
| 1 BAR | 2 BAR | 3 BAR |
| 2,3 l/m | 3,2 l/m | 4 l/m |

PACKAGING

L: 370 mm
D: 270 mm
H: 80 mm

3,1 kg

Built-in body to be purchased separately

Corpo incasso da acquistare separatamente

Corps intégré à acheter séparément



CODICE | CODE | CODE

INC206XXXN_19

COEFFICIENTE | COEFFICIENT | COEFFICIENT

2,9



MODERNA / ACCESSORIES COLLECTION

ARTICLE | ARTICOLO | ARTICLE

MO001

Wall soap-holder

Porta sapone a muro
Porte distributeur de savon encastré

CODE / COEFFICIENT | CODICE /
COEFFICIENTE | CODE / COEFFICIENT

CC MO001CC 1,5

PACKAGING

L: 110 mm
D: 130 mm
H: 50 mm

0,4 kg

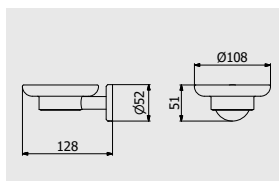

ARTICLE | ARTICOLO | ARTICLE

MO002

Wall soap dispenser holder

Porta dispenser sapone liquido a parete
Porte distributeur de savon en verre gravé

CODE / COEFFICIENT | CODICE /
COEFFICIENTE | CODE / COEFFICIENT

CC MO002CC 2,3

PACKAGING

L: 80 mm
D: 130 mm
H: 180 mm

0,1 kg

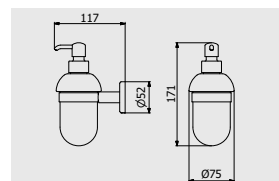

ARTICLE | ARTICOLO | ARTICLE

MO003

Wall toothbrush holder

Bicchiera porta spazzolino a parete
Porte-verre en verre gravé

CODE / COEFFICIENT | CODICE /
COEFFICIENTE | CODE / COEFFICIENT

CC MO003CC 1,5

PACKAGING

L: 70 mm
D: 110 mm
H: 100 mm

0,4 kg

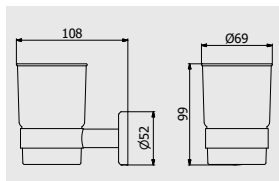

ARTICLE | ARTICOLO | ARTICLE

MO004

Towel holder

Porta salvietta
Porte-serviette

CODE / COEFFICIENT | CODICE /
COEFFICIENTE | CODE / COEFFICIENT

CC MO004CC 2,4

PACKAGING

L: 650 mm
D: 70 mm
H: 50 mm

0,5 kg

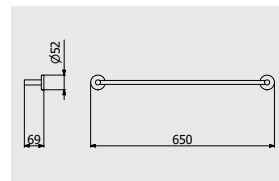

ARTICLE | ARTICOLO | ARTICLE

MO014

Towel holder

Porta salvietta
Porte-serviette

CODE / COEFFICIENT | CODICE /
COEFFICIENTE | CODE / COEFFICIENT

CC MO014CC 2,2

PACKAGING

L: 500 mm
D: 70 mm
H: 50 mm

0,5 kg

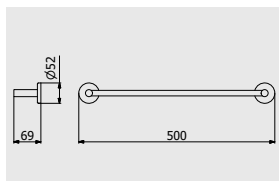

ARTICLE | ARTICOLO | ARTICLE

MO006

Towel holder

Porta salvietta
Porte-serviette

CODE / COEFFICIENT | CODICE /
COEFFICIENTE | CODE / COEFFICIENT

CC MO006CC 2,1

PACKAGING

L: 350 mm
D: 70 mm
H: 50 mm

0,4 kg

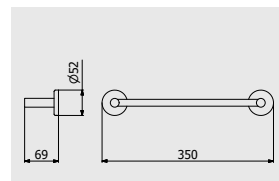

Rubacuori

ARTICLE | ARTICOLO | ARTICLE

M0007



Ring Towel holder

Porta salvietta ad anello

Porte-serviette anneau

CODE / COEFFICIENT | CODICE /
COEFFICIENTE | CODE / COEFFICIENT

CC M0007CC 1,6

PACKAGING

L: 180 mm 0,8 kg
D: 70 mm
H: 200 mm

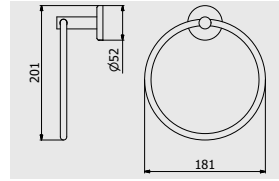

ARTICLE | ARTICOLO | ARTICLE

M0008



Robe Hook

Appendino a parete

Cintre

CODE / COEFFICIENT | CODICE /
COEFFICIENTE | CODE / COEFFICIENT

CC M0008CC 0,9

PACKAGING

L: 50 mm 0,3 kg
D: 50 mm
H: 50 mm

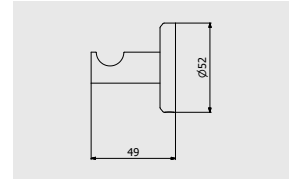

ARTICLE | ARTICOLO | ARTICLE

M0009



Double robe hook

Doppio appendino a parete

Double cintre

CODE / COEFFICIENT | CODICE /
COEFFICIENTE | CODE / COEFFICIENT

CC M0009CC 1,4

PACKAGING

L: 70 mm 0,1 kg
D: 70 mm
H: 50 mm

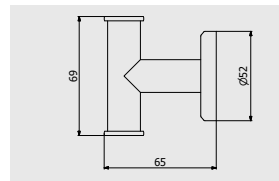

ARTICLE | ARTICOLO | ARTICLE

M0010



Shelf

Mensola

Etagère

CODE / COEFFICIENT | CODICE /
COEFFICIENTE | CODE / COEFFICIENT

CC M0010CC 3,0

PACKAGING

L: 600 mm 0,3 kg
D: 140 mm
H: 50 mm

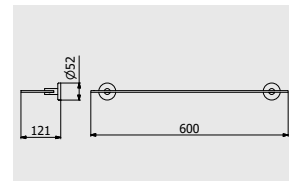

ARTICLE | ARTICOLO | ARTICLE

M0005



Swiveable towel holder

Porta salvietta doppio

Porte-serviette noeud

CODE / COEFFICIENT | CODICE /
COEFFICIENTE | CODE / COEFFICIENT

CC M0005CC 3,5

PACKAGING

L: 430 mm 0,5 kg
D: 70 mm
H: 50 mm

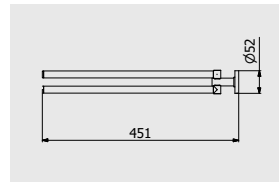

ARTICLE | ARTICOLO | ARTICLE

M0011



Toilet paper holder

Porta rotolo

Porte rouleaux de toilette

CODE / COEFFICIENT | CODICE /
COEFFICIENTE | CODE / COEFFICIENT

CC M0011CC 1,4

PACKAGING

L: 150 mm 0,2 kg
D: 70 mm
H: 50 mm

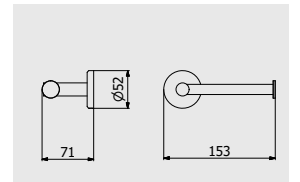

ARTICLE | ARTICOLO | ARTICLE

M0012



Toilet brush holder

Porta scopino da terra

Porte balayette au sol

CODE / COEFFICIENT | CODICE /
COEFFICIENTE | CODE / COEFFICIENT

CC M0012CC 2,5

PACKAGING

L: 80 mm 0,7 kg
D: 80 mm
H: 380 mm

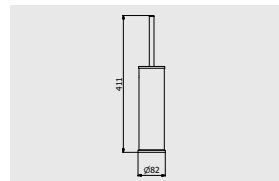

ARTICLE | ARTICOLO | ARTICLE

M0013



Wall toilet brush holder

Porta scopino da parete

Porte balayette

CODE / COEFFICIENT | CODICE /
COEFFICIENTE | CODE / COEFFICIENT

CC M0013CC 2,9

PACKAGING

L: 80 mm 0,7 kg
D: 80 mm
H: 380 mm

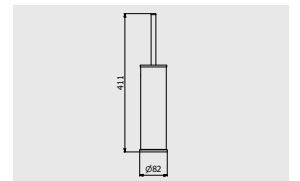

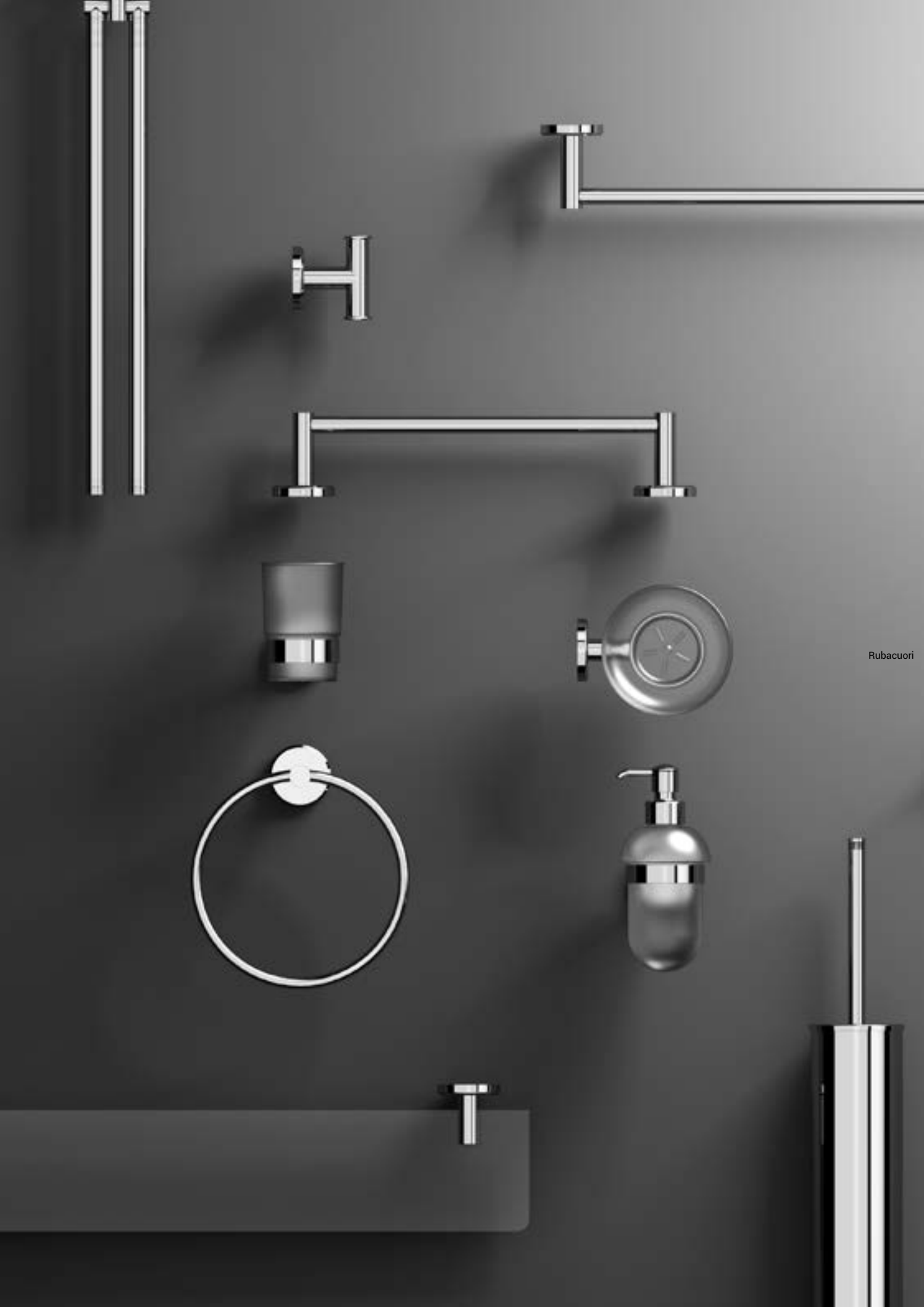

Rubacuori

HEY JOE!

It excites the eye and the imagination just like the Jimi Hendrix's guitar solos.

Stuzzica l'occhio e la fantasia proprio come gli assoli di chitarra di Jimi Hendrix.

Il excite à la fois le regard et l'imagination, exactement comme les solos de Jimi Hendrix.

Iridescent to the touch and built on the contrast between a strongly characterized body and a sinuous and thin lever, HEY JOE! is a versatile collection, with a strong and elusive line, which excites the eye and arouses the imagination just like the powerful and ephemeral Jimi Hendrix's guitar solos, to whom the collection pays tribute.

Cangiante al tatto e costruita sul contrasto tra una base dal carattere deciso e una leva sinuosa e sottile, HEY JOE! è una collezione versatile, dal tratto forte ed elusivo, che stuzzica l'occhio e la fantasia proprio come gli assoli di chitarra di Jimi Hendrix, potenti ed effimeri, a cui il nome della serie rende omaggio.

Changeant au toucher et construit à partir du contraste entre une base au caractère fort et un levier sinueux et fin, HEY JOE! est une collection polyvalente, avec une ligne forte et évasive, qui excite à la fois le regard et l'imagination, exactement comme les solos de guitare puissants et éphémères de Jimi Hendrix, à qui le nom de la collection rend hommage.



KITCHEN
AVAILABLE



CRYSTAL CLEAR
WATER



LEAD FREE



ZINC FREE





HeyJoe

DESIGN
MAURIZIO DURANTI

**“ At 3 o’ clock in the night,
even the true things
seem false and ephemeral.
I was thinking about this,
while Hendrix was throwing
the guitar solos of Hey Joe,
and it was as if he was
saying, without arrogance:
from now on this is the way
to play!**

Alle 3 del mattino, persino le cose vere sembrano false ed effimere. Stavo pensando a questo quando Hendrix stava suonando la chitarra nell'assolo di Hey Joe, ed era come se lo stesse dicendo, senza arroganza: d'ora in poi questo è il modo di suonare!

À 3 heures du matin, même les choses les plus vraies paraissent fausses et éphémères. Je pensais à cela, pendant que Hendrix lançait sa guitare dans les solos de Hey Joe, et c'était comme s'il disait, sans arrogance: à partir de ce moment, il faut jouer comme ça!

”

Maurizio Duranti design for HEY JOE!



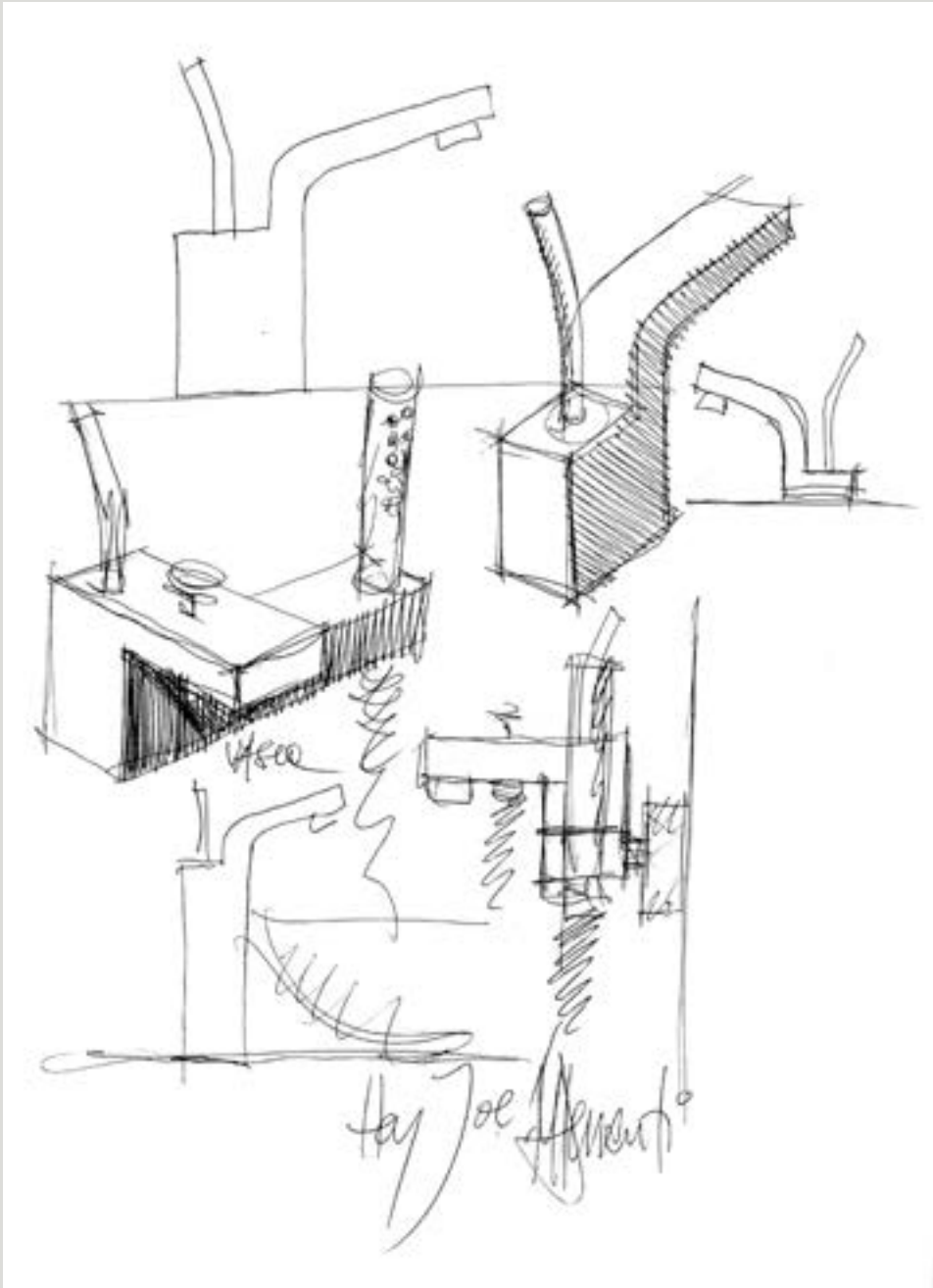

HeyJoe





- ← HJ202NP
Tall monohole washbasin mixer
Miscelatore lavabo monoforo alto
Mitigeur lavabo haut
- ↑ HJ206CC
Wall mounted washbasin mixer
Miscelatore lavabo due fori a parete
Mitigeur lavabo encastré
- HJ200CC
Monohole washbasin mixer
Miscelatore lavabo monoforo
Mitigeur lavabo

HeyJoe







← HJ350CC
Wall mounted shower mixer with shower kit
Doccia esterno a parete con kit doccia
Mitigeur de douche externe avec flexible et
douchette

→ HJ320CC
Wall mounted spout
Bocca d'erogazione a parete
Bec de remplissage mural



HeyJoe



↖ **K2314CC**
Exposed parts for manual wall mixer with three ways with shower kit
Set di parti esterne per miscelatore a parete a tre vie completo di kit doccia
Partie extérieure pour mitigeur encastré à trois voies avec douchette

→ **HJ800CC**
Shower column with mixer and shower kit
Colonna doccia con miscelatore e e kit doccia
Colonne de douche avec mitigeur et kit douche





↖ HJ399CC
← Free-standing bath filler with shower kit
Bordo vasca da terra con kit doccia
Bain douche complet alimentation au sol

ARTICLE | ARTICOLO | ARTICLE

HJ200



Monohole washbasin mixer complete with drain
 Miscelatore lavabo monoforo completo di scarico automatico
 Mitigeur Lavabo complet avec bonde automatique

| CODICE / COEFFICIENTE CODE / COEFFICIENT | |
|--|-------------|
| ● CC | HJ200CC 7,5 |
| ● SS | HJ200SS 9,4 |
| ● NP | HJ200NP 9,0 |

PACKAGING
 L: 240 mm
 D: 215 mm
 H: 110 mm
 2,9 kg

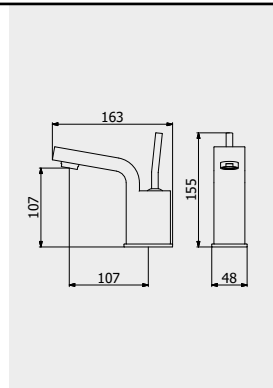

| PORTATE WATER FLOW DÉBIT D'EAU | | |
|------------------------------------|----------|----------|
| 1 BAR | 2 BAR | 3 BAR |
| 14,4 l/m | 20,6 l/m | 25,4 l/m |

ARTICLE | ARTICOLO | ARTICLE

HJ204



Mid-size monohole washbasin mixer complete with drain
 Miscelatore lavabo monoforo medio completo di scarico automatico
 Mitigeur Lavabo Moyen complet avec bonde automatique

| CODICE / COEFFICIENTE CODE / COEFFICIENT | |
|--|--------------|
| ● CC | HJ204CC 12,4 |
| ● SS | HJ204SS 15,5 |
| ● NP | HJ204NP 14,9 |

PACKAGING
 L: 455 mm
 D: 310 mm
 H: 75 mm
 3,3 kg

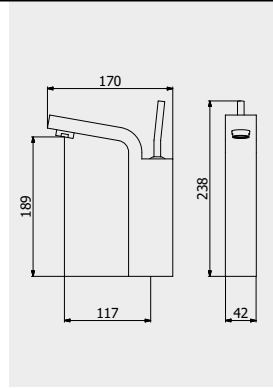

| PORTATE WATER FLOW DÉBIT D'EAU | | |
|------------------------------------|----------|----------|
| 1 BAR | 2 BAR | 3 BAR |
| 14,4 l/m | 20,6 l/m | 25,4 l/m |

HeyJoe

ARTICLE | ARTICOLO | ARTICLE

HJ202



Tall monohole washbasin mixer complete with drain
 Miscelatore lavabo monoforo alto completo di scarico automatico
 Mitigeur lavabo Haut complet avec bonde automatique

| CODICE / COEFFICIENTE CODE / COEFFICIENT | |
|--|--------------|
| ● CC | HJ202CC 15,5 |
| ● SS | HJ202SS 19,4 |
| ● NP | HJ202NP 18,6 |

PACKAGING
 L: 455 mm
 D: 310 mm
 H: 75 mm
 4,3 kg

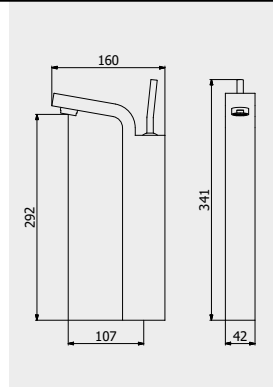

| PORTATE WATER FLOW DÉBIT D'EAU | | |
|------------------------------------|----------|----------|
| 1 BAR | 2 BAR | 3 BAR |
| 14,4 l/m | 20,6 l/m | 25,4 l/m |

ARTICLE | ARTICOLO | ARTICLE

HJ206



Wall mounted washbasin mixer complete with drain

Miscelatore lavabo due fori a parete completo di scarico automatico

Mitigeur lavabo mural complet avec bonde automatique

| CODICE / COEFFICIENTE | CODE / COEFFICIENT | |
|-----------------------|--------------------|------|
| CC | EHJ206CC | 8,8 |
| SS | EHJ206SS | 11,0 |
| NP | EHJ206NP | 10,6 |

PACKAGING

L: 265 mm
D: 260 mm
H: 70 mm

1,8 kg

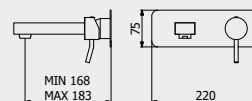

PORTATE | WATER FLOW | DÉBIT D'EAU

| 1 BAR | 2 BAR | 3 BAR |
|---------|----------|----------|
| 8,8 l/m | 12,3 l/m | 15,2 l/m |

Built-in body to be purchased separately

Corpo incasso da acquistare separatamente

Corps intégré à acheter séparément



CODICE | CODE | CODE

INC206XXXN_19

COEFFICIENTE | COEFFICIENT | COEFFICIENT

2,9



ARTICLE | ARTICOLO | ARTICLE

HJ207



Wall mounted washbasin mixer with long spout complete with drain

Miscelatore lavabo due fori a parete con bocca lunga completo di scarico

Mitigeur lavabo mural bec long complet avec bonde automatique

| CODICE / COEFFICIENTE | CODE / COEFFICIENT | |
|-----------------------|--------------------|------|
| CC | EHJ207CC | 9,6 |
| SS | EHJ207SS | 12,0 |
| NP | EHJ207NP | 11,5 |

PACKAGING

L: 265 mm
D: 260 mm
H: 70 mm

1,8 kg

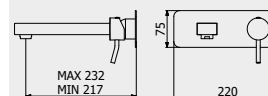

PORTATE | WATER FLOW | DÉBIT D'EAU

| 1 BAR | 2 BAR | 3 BAR |
|---------|----------|----------|
| 8,8 l/m | 12,3 l/m | 15,2 l/m |

Built-in body to be purchased separately

Corpo incasso da acquistare separatamente

Corps intégré à acheter séparément



CODICE | CODE | CODE

INC206XXXN_19

COEFFICIENTE | COEFFICIENT | COEFFICIENT

2,9



ARTICLE | ARTICOLO | ARTICLE

HJ208



Wall mounted washbasin mixer with short spout complete with drain

Miscelatore lavabo due fori a parete con bocca corta completo di scarico

Mitigeur lavabo mural bec court complet avec bonde automatique

| CODICE / COEFFICIENTE | CODE / COEFFICIENT | |
|-----------------------|--------------------|------|
| CC | EHJ208CC | 9,6 |
| SS | EHJ208SS | 12,0 |
| NP | EHJ208NP | 11,5 |

PACKAGING

L: 265 mm
D: 260 mm
H: 70 mm

1,8 kg

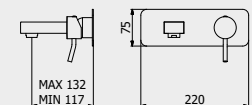

PORTATE | WATER FLOW | DÉBIT D'EAU

| 1 BAR | 2 BAR | 3 BAR |
|---------|----------|----------|
| 8,8 l/m | 12,3 l/m | 15,2 l/m |

Built-in body to be purchased separately

Corpo incasso da acquistare separatamente

Corps intégré à acheter séparément



CODICE | CODE | CODE

INC206XXXN_19

COEFFICIENTE | COEFFICIENT | COEFFICIENT

2,9



ARTICLE | ARTICOLO | ARTICLE

HJ210



Ceiling spout with wall mounted mixer

Bocca da soffitto con comando remoto ad incasso

Mitigeur lavabo mural avec bec plafond complet avec bonde automatique

| CODICE / COEFFICIENTE CODE / COEFFICIENT | |
|--|---------------|
| CC | EHJ210CC 33,8 |
| SS | EHJ210SS 42,3 |

PACKAGING

- L: 150 mm
D: 190 mm
H: 98 mm
- L: 1700 mm
Ø: 70 mm
- 4,5 kg

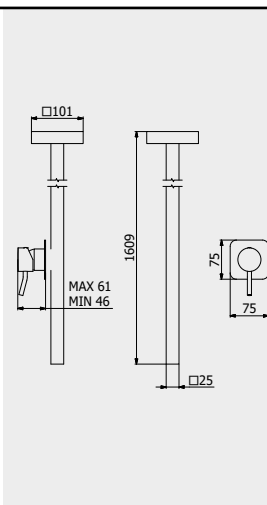

PORTATE | WATER FLOW | DÉBIT D'EAU

| 1 BAR | 2 BAR | 3 BAR |
|---------|---------|-------|
| 4,3 l/m | 5,2 l/m | 7 l/m |

Built-in body to be purchased separately

Corpo incasso da acquistare separatamente

Corps intégré à acheter séparément



CODICE | CODE | CODE

INC300XXXN_19

COEFFICIENTE | COEFFICIENT | COEFFICIENT

1,8

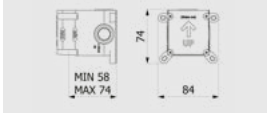

ARTICLE | ARTICOLO | ARTICLE

HJ299



Monohole free-standing washbasin mixer complete with drain

Miscelatore lavabo da terra completo di scarico automatico

Mitigeur lavabo free standing complet avec bonde automatique

| CODICE / COEFFICIENTE CODE / COEFFICIENT | |
|--|--------------|
| CC | HJ299CC 30,1 |
| SS | HJ299SS 37,6 |
| NP | HJ299NP 36,1 |

PACKAGING

- L: 1160 mm
D: 360 mm
H: 180 mm
- 13,8 kg

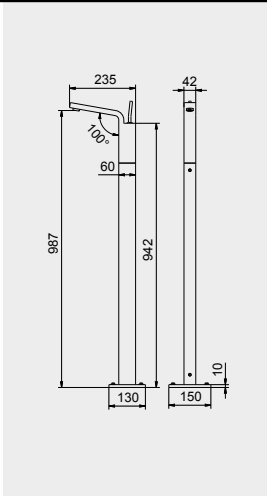

PORTATE | WATER FLOW | DÉBIT D'EAU

| 1 BAR | 2 BAR | 3 BAR |
|----------|----------|----------|
| 14,4 l/m | 20,6 l/m | 25,4 l/m |

HeyJoe

ARTICLE | ARTICOLO | ARTICLE

HJ220



Monohole bidet mixer complete with drain

Miscelatore bidet monoforo completo di scarico automatico

Mitigeur bidet complet avec bonde automatique

CODICE / COEFFICIENTE | CODE /
COEFFICIENT | CODE / COEFFICIENT

| | | |
|------|---------|-----|
| ● CC | HJ220CC | 7,5 |
| ● SS | HJ220SS | 9,4 |
| ● NP | HJ220NP | 9,0 |

PACKAGING

L: 240 mm
D: 215 mm
H: 110 mm

2,9 kg

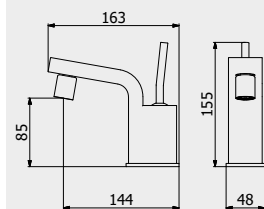

PORTATE | WATER FLOW | DÉBIT D'EAU

| | | |
|--------|----------|--------|
| 1 BAR | 2 BAR | 3 BAR |
| 10 l/m | 14,5 l/m | 18 l/m |

ARTICLE | ARTICOLO | ARTICLE

HJ300



Exposed parts for manual wall mixer

Set di parti esterne per miscelatore a parete ad una via

Partie extérieure pour mitigeur encastré à une voie

CODICE / COEFFICIENTE | CODE /
COEFFICIENT | CODE / COEFFICIENT

| | | |
|------|----------|-----|
| ● CC | EHJ300CC | 4,1 |
| ● SS | EHJ300SS | 5,1 |
| ● NP | EHJ300NP | 4,9 |

PACKAGING

L: 150 mm
D: 190 mm
H: 98 mm

1,8 kg

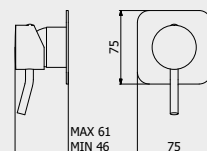

PORTATE | WATER FLOW | DÉBIT D'EAU

| | | |
|----------|----------|--------|
| 1 BAR | 2 BAR | 3 BAR |
| 11,5 l/m | 16,3 l/m | 20 l/m |

Built-in body to be purchased separately

Corpo incasso da acquistare separatamente

Corps intégré à acheter séparément



CODICE | CODE | CODE

INC300XXXN_19

COEFFICIENTE | COEFFICIENT | COEFFICIENT

1,8



ARTICLE | ARTICOLO | ARTICLE

HJ310



Exposed parts for manual wall mixer with two ways diverter

Miscelatore doccia a parete con deviatore due vie

Mitigeur douche mural deux voies avec inverseur

CODICE / COEFFICIENTE | CODE /
COEFFICIENT | CODE / COEFFICIENT

| | | |
|------|----------|-----|
| ● CC | EHJ310CC | 6,1 |
| ● SS | EHJ310SS | 7,6 |
| ● NP | EHJ310NP | 7,3 |

PACKAGING

L: 150 mm
D: 190 mm
H: 98 mm

1,8 kg

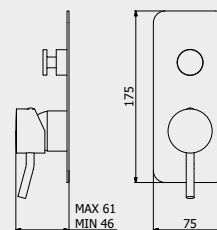

PORTATE | WATER FLOW | DÉBIT D'EAU

| | | |
|---------|----------|--------|
| 1 BAR | 2 BAR | 3 BAR |
| 9,2 l/m | 12,8 l/m | 16 l/m |

Built-in body to be purchased separately

Corpo incasso da acquistare separatamente

Corps intégré à acheter séparément



CODICE | CODE | CODE

INC310XXXN_19

COEFFICIENTE | COEFFICIENT | COEFFICIENT

3,3

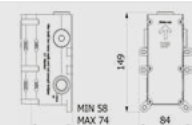

ARTICLE | ARTICOLO | ARTICLE

HJ312



Exposed parts for manual wall mixer with three ways diverter
Set di parti esterne per miscelatore a parete a tre vie
Mitigeur douche mural trois voies avec inverseur

| CODICE / COEFFICIENTE CODE / COEFFICIENT | | |
|--|----------|-----|
| CC | EHJ312CC | 7,4 |
| SS | EHJ312SS | 9,3 |
| NP | EHJ312NP | 8,9 |

PACKAGING

L: 150 mm
D: 190 mm
H: 98 mm
1,8 kg

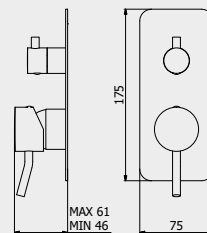

PORTATE | WATER FLOW | DÉBIT D'EAU

| 1 BAR | 2 BAR | 3 BAR |
|---------|----------|----------|
| 8,3 l/m | 11,7 l/m | 14,3 l/m |

Built-in body to be purchased separately

Corpo incasso da acquistare separatamente
Corps intégré à acheter séparément



CODICE | CODE | CODE

INC312XXXN_19

COEFFICIENTE | COEFFICIENT | COEFFICIENT

3,3

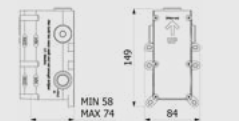

ARTICLE | ARTICOLO | ARTICLE

HJ313



Exposed parts for manual wall mixer with 2 ways with shower kit
Set di parti esterne per miscelatore a parete a due vie completo di kit doccia
Partie extérieure pour mitigeur encastré à deux voies avec douchette

| CODICE / COEFFICIENTE CODE / COEFFICIENT | | |
|--|----------|------|
| CC | EHJ313CC | 10,1 |
| SS | EHJ313SS | 12,6 |
| NP | EHJ313NP | 12,1 |

PACKAGING

L: 370 mm
D: 270 mm
H: 80 mm
2,1 kg

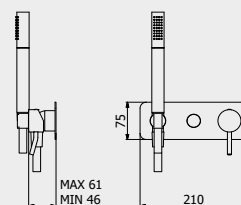

PORTATE | WATER FLOW | DÉBIT D'EAU

| 1 BAR | 2 BAR | 3 BAR |
|--------|----------|----------|
| 10 l/m | 14,1 l/m | 17,2 l/m |

Built-in body to be purchased separately

Corpo incasso da acquistare separatamente
Corps intégré à acheter séparément



CODICE | CODE | CODE

INC313XXXN_19

COEFFICIENTE | COEFFICIENT | COEFFICIENT

3,6



ARTICLE | ARTICOLO | ARTICLE

HJ314



Exposed parts for manual wall mixer with 3 ways with shower kit
Set di parti esterne per miscelatore a parete a tre vie completo di kit doccia
Partie extérieure pour mitigeur encastré à trois voies avec douchette

| CODICE / COEFFICIENTE CODE / COEFFICIENT | | |
|--|----------|------|
| CC | EHJ314CC | 11,4 |
| SS | EHJ314SS | 14,3 |
| NP | EHJ314NP | 13,7 |

PACKAGING

L: 370 mm
D: 270 mm
H: 80 mm
2,1 kg

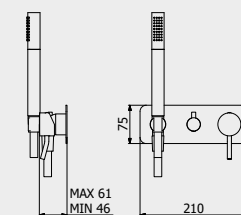

PORTATE | WATER FLOW | DÉBIT D'EAU

Built-in body to be purchased separately

Corpo incasso da acquistare separatamente
Corps intégré à acheter séparément



CODICE | CODE | CODE

INC314XXXN_19

COEFFICIENTE | COEFFICIENT | COEFFICIENT

3,7



HeyJoe

ARTICLE | ARTICOLO | ARTICLE

HJ250



Wall mounted bath filler complete with hand shower kit
Bordo vasca esterno a parete completo di kit doccia
Mitigeur Bain/douche Mural avec douchette encastrée

CODICE / COEFFICIENTE | CODE /
COEFFICIENT | CODE / COEFFICIENT

| | | |
|------|---------|------|
| ● CC | HJ250CC | 17,1 |
| ● SS | HJ250SS | 21,4 |
| ● NP | HJ250NP | 20,5 |

PACKAGING

L: 360 mm
D: 220 mm
H: 220 mm

5,3 kg

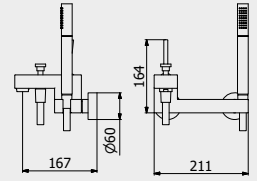
**PORTATE | WATER FLOW | DÉBIT D'EAU**

| | | |
|----------|--------|--------|
| 1 BAR | 2 BAR | 3 BAR |
| 12,5 l/m | 18 l/m | 20 l/m |

ARTICLE | ARTICOLO | ARTICLE

HJ399



Free-standing bath filler with shower kit
Bordo vasca da terra con kit doccia
Bain douche complet alimentation au sol

CODICE / COEFFICIENTE | CODE /
COEFFICIENT | CODE / COEFFICIENT

| | | |
|------|---------|------|
| ● CC | HJ399CC | 41,9 |
| ● SS | HJ399SS | 52,4 |
| ● NP | HJ399NP | 50,3 |

PACKAGING

L: 1080 mm
D: 384 mm
H: 120 mm

15 kg

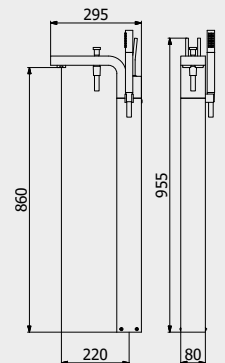
**PORTATE | WATER FLOW | DÉBIT D'EAU**

| | | |
|--------|--------|--------|
| 1 BAR | 2 BAR | 3 BAR |
| 18 l/m | 25 l/m | 31 l/m |

ARTICLE | ARTICOLO | ARTICLE

HJ740



Two holes deck mounted bath filler mixer with shower kit
Miscelatore Bordo vasca da appoggio due fori con doccino
Mitigeur bain/douche deux trous avec douchette

CODICE / COEFFICIENTE | CODE /
COEFFICIENT | CODE / COEFFICIENT

| | | |
|------|---------|------|
| ● CC | HJ740CC | 21,4 |
| ● SS | HJ740SS | 26,8 |
| ● NP | HJ740NP | 25,7 |

PACKAGING

L: 360 mm
D: 220 mm
H: 150 mm

5,2 kg

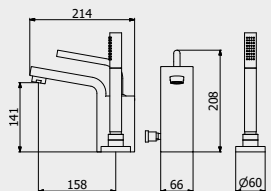
**PORTATE | WATER FLOW | DÉBIT D'EAU**

| | | |
|----------|--------|--------|
| 1 BAR | 2 BAR | 3 BAR |
| 21,5 l/m | 30 l/m | 38 l/m |



ARTICLE | ARTICOLO | ARTICLE

HJ750



Deck mounted bath filler mixer
Miscelatore bordo vasca da appoggio
Mitigeur bain/douche

| CODICE / COEFFICIENTE | CODE / COEFFICIENT |
|-----------------------|--------------------|
| CC HJ750CC | 17,5 |
| SS HJ750SS | 21,9 |
| NP HJ750NP | 21,0 |

PACKAGING

L: 360 mm
D: 220 mm
H: 150 mm
4,2 kg

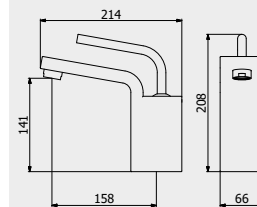

PORTATE | WATER FLOW | DÉBIT D'EAU

| 1 BAR | 2 BAR | 3 BAR |
|----------|--------|--------|
| 21,5 l/m | 30 l/m | 38 l/m |

ARTICLE | ARTICOLO | ARTICLE

RU318



Built-in wall mounted waterfall spout
Cascata a parete con erogazione a lama esterna
Cascade murale avc bec externe

| CODICE / COEFFICIENTE | CODE / COEFFICIENT |
|-----------------------|--------------------|
| CC RU318CC | 22,9 |
| SS RU318SS | 28,6 |
| NP RU318NP | 27,5 |

PACKAGING

L: 340 mm
D: 180 mm
H: 70 mm
4,0 kg

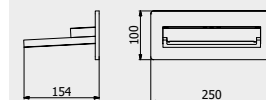

PORTATE | WATER FLOW | DÉBIT D'EAU

| 1 BAR | 2 BAR | 3 BAR |
|--------|----------|--------|
| 13 l/m | 17,7 l/m | 20 l/m |

HeyJoe

ARTICLE | ARTICOLO | ARTICLE

RU319



Wall mounted waterfall
Cascata a parete con erogazione diretta
Cascade murale

| CODICE / COEFFICIENTE | CODE / COEFFICIENT |
|-----------------------|--------------------|
| CC RU319CC | 12,8 |
| SS RU319SS | 16,0 |
| NP RU319NP | 15,4 |

PACKAGING

L: 340 mm
D: 180 mm
H: 70 mm
3,1 kg

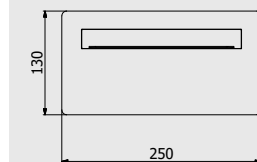

PORTATE | WATER FLOW | DÉBIT D'EAU

| 1 BAR | 2 BAR | 3 BAR |
|--------|----------|--------|
| 13 l/m | 17,7 l/m | 20 l/m |

ARTICLE | ARTICOLO | ARTICLE

RU320



Wall mounted spout

Bocca d'erogazione a parete

Bec de remplissage mural

CODICE / COEFFICIENTE | CODE /
COEFFICIENT | CODE / COEFFICIENT

| | | |
|------|---------|-----|
| ● CC | RU320CC | 2,5 |
| ● SS | RU320SS | 3,1 |
| ● NP | RU320NP | 3,0 |

PACKAGING

L: 210 mm
D: 130 mm
H: 70 mm

1,1 kg

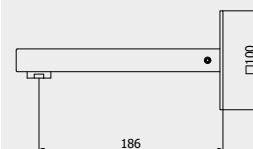

PORTATE | WATER FLOW | DÉBIT D'EAU

| | | |
|--------|--------|--------|
| 1 BAR | 2 BAR | 3 BAR |
| 15 l/m | 19 l/m | 24 l/m |

ARTICLE | ARTICOLO | ARTICLE

RU321



Short wall mounted spout

Bocca d'erogazione corta a parete

Bec de remplissage mural court

CODICE / COEFFICIENTE | CODE /
COEFFICIENT | CODE / COEFFICIENT

| | | |
|------|---------|-----|
| ● CC | RU321CC | 3,0 |
| ● SS | RU321SS | 3,8 |
| ● NP | RU321NP | 3,6 |

PACKAGING

L: 210 mm
D: 130 mm
H: 70 mm

1 kg

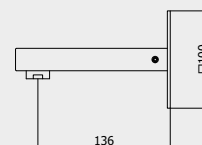

PORTATE | WATER FLOW | DÉBIT D'EAU

| | | |
|--------|--------|--------|
| 1 BAR | 2 BAR | 3 BAR |
| 15 l/m | 19 l/m | 24 l/m |

ARTICLE | ARTICOLO | ARTICLE

RU322



Long wall mounted spout

Bocca d'erogazione lunga a parete

Bec de remplissage mural long

CODICE / COEFFICIENTE | CODE /
COEFFICIENT | CODE / COEFFICIENT

| | | |
|------|---------|-----|
| ● CC | RU322CC | 3,0 |
| ● SS | RU322SS | 3,8 |
| ● NP | RU322NP | 3,6 |

PACKAGING

L: 210 mm
D: 130 mm
H: 70 mm

1,2 kg



PORTATE | WATER FLOW | DÉBIT D'EAU

| | | |
|--------|--------|--------|
| 1 BAR | 2 BAR | 3 BAR |
| 15 l/m | 19 l/m | 24 l/m |

ARTICLE | ARTICOLO | ARTICLE

HJ800



Shower column with mixer and shower kit

Colonna doccia con miscelatore e e kit doccia

Ccolonne de douche avec mitigeur et kit douche

CODICE / COEFFICIENTE | CODE /
COEFFICIENT | CODE / COEFFICIENT

| | | |
|------|---------|------|
| ● CC | HJ800CC | 52,9 |
|------|---------|------|

PACKAGING

L: 3700 mm
D: 2800 mm
H: 1070 mm

14,7 kg

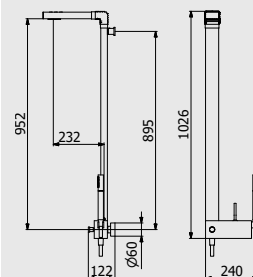

PORTATE | WATER FLOW | DÉBIT D'EAU

| | | |
|---------|--------|----------|
| 1 BAR | 2 BAR | 3 BAR |
| 9,6 l/m | 15 l/m | 18,5 l/m |

ARTICLE | ARTICOLO | ARTICLE

HJ706



Exposed parts for bidet spray complete with mixer
 Set di parti esterne per Idroscopino igienico con miscelatore
 Partie extérieure pour douchette hygiénique avec mitigeur

| CODE / COEFFICIENT | CODE / COEFFICIENT | CODE / COEFFICIENT |
|--------------------|--------------------|--------------------|
| ● CC | EHJ706CC | 9,8 |
| ● SS | EHJ706SS | 12,3 |
| ● NP | EHJ706NP | 11,8 |

PACKAGING

L: 370 mm
 D: 270 mm
 H: 80 mm

3,1 kg

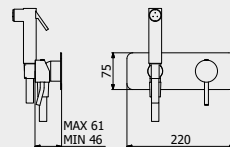

PORTATE | WATER FLOW | DÉBIT D'EAU

| 1 BAR | 2 BAR | 3 BAR |
|---------|---------|-------|
| 2,3 l/m | 3,2 l/m | 4 l/m |

Built-in body to be purchased separately
 Corpo incasso da acquistare separatamente
 Corps intégré à acheter séparément



CODICE | CODE | CODE
INC206XXXN_19

COEFFICIENTE | COEFFICIENT | COEFFICIENT

2,9



ARTICLE | ARTICOLO | ARTICLE

HJ370



Single Lever kitchen mixer
 Lavello monoforo da cucina
 Évier de cuisine

| CODE / COEFFICIENT | CODE / COEFFICIENT | CODE / COEFFICIENT |
|--------------------|--------------------|--------------------|
| ● CC | HJ370CC | 14,0 |
| ● SS | HJ370SS | 17,5 |
| ● NP | HJ370NP | 16,8 |

PACKAGING

L: 455 mm
 D: 310 mm
 H: 75 mm

3,4 kg

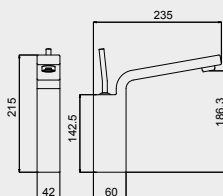

PORTATE | WATER FLOW | DÉBIT D'EAU

| 1 BAR | 2 BAR | 3 BAR |
|----------|----------|----------|
| 14,4 l/m | 20,6 l/m | 25,4 l/m |

HeyJoe

SNATCH / ACCESSORIES COLLECTION

ARTICLE | ARTICOLO | ARTICLE

HJ001

Wall soap-holder
Porta sapone a muro
Porte distributeur de savon encastré



CODICE / COEFFICIENTE | CODE / COEFFICIENT

| | | |
|----|---------|-----|
| CC | HJ001CC | 5,5 |
| SS | HJ001SS | 5,7 |
| BO | HJ001BO | 5,7 |
| NP | HJ001NP | 5,7 |
| CF | HJ001CF | 5,7 |
| CS | HJ001CS | 5,7 |
| II | HJ001II | 5,7 |
| IS | HJ001IS | 5,7 |
| RS | HJ001RS | 5,7 |
| SR | HJ001SR | 5,7 |
| OO | HJ001OO | 5,7 |
| OS | HJ001OS | 5,7 |

PACKAGING

L: 150 mm
D: 190 mm
H: 98 mm

0,4 kg

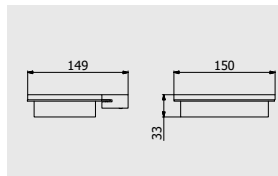

ARTICLE | ARTICOLO | ARTICLE

HJ003

Wall toothbrush holder
Porta spazzolino a muro
Porte brosse à dents encastré



CODICE / COEFFICIENTE | CODE / COEFFICIENT

| | | |
|----|---------|-----|
| CC | HJ003CC | 6,1 |
| SS | HJ003SS | 6,3 |
| BO | HJ003BO | 6,3 |
| NP | HJ003NP | 6,3 |
| CF | HJ003CF | 6,3 |
| CS | HJ003CS | 6,3 |
| II | HJ003II | 6,3 |
| IS | HJ003IS | 6,3 |
| RS | HJ003RS | 6,3 |
| SR | HJ003SR | 6,3 |
| OO | HJ003OO | 6,3 |
| OS | HJ003OS | 6,3 |

PACKAGING

L: 175 mm
D: 125 mm
H: 90 mm

0,2 kg

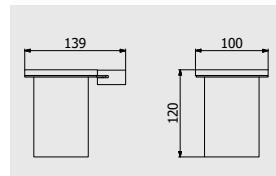

ARTICLE | ARTICOLO | ARTICLE

HJ016

Soap dispenser
Porta sapone da appoggio
Porte distributeur de savon



CODICE / COEFFICIENTE | CODE / COEFFICIENT

| | | |
|----|---------|-----|
| CC | HJ016CC | 2,2 |
| SS | HJ016SS | 2,4 |
| BO | HJ016BO | 2,4 |
| NP | HJ016NP | 2,4 |
| CF | HJ016CF | 2,4 |
| CS | HJ016CS | 2,4 |
| II | HJ016II | 2,4 |
| IS | HJ016IS | 2,4 |
| RS | HJ016RS | 2,4 |
| SR | HJ016SR | 2,4 |
| OO | HJ016OO | 2,4 |
| OS | HJ016OS | 2,4 |

PACKAGING

L: 150 mm
D: 190 mm
H: 98 mm

1,1 kg

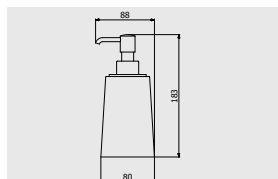

ARTICLE | ARTICOLO | ARTICLE

HJ017

Soap holder
Porta sapone da appoggio
Porte savon



CODICE / COEFFICIENTE | CODE / COEFFICIENT

| | | |
|----|---------|-----|
| CC | HJ017CC | 3,8 |
|----|---------|-----|

PACKAGING

L: 175 mm
D: 125 mm
H: 90 mm

0,5 kg

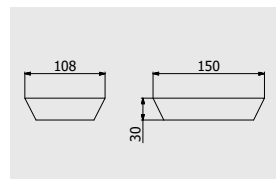

ARTICLE | ARTICOLO | ARTICLE

HJ010



Shelf
Mensola
Etagèr

CODICE / COEFFICIENTE | CODE / COEFFICIENT

| | | |
|----|---------|-----|
| CC | HJ010CC | 5,1 |
| SS | HJ010SS | 5,3 |
| BO | HJ010BO | 5,3 |
| NP | HJ010NP | 5,3 |
| CF | HJ010CF | 5,3 |
| CS | HJ010CS | 5,3 |
| II | HJ010II | 5,3 |
| IS | HJ010IS | 5,3 |
| RS | HJ010RS | 5,3 |
| SR | HJ010SR | 5,3 |
| OO | HJ010OO | 5,3 |
| OS | HJ010OS | 5,3 |

PACKAGING

| | | | |
|--|------------------------------------|--|--------|
| | L: 175 mm D: 125 mm H: 90 mm | | 0,4 kg |
|--|------------------------------------|--|--------|

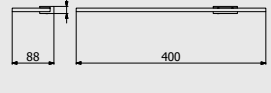

ARTICLE | ARTICOLO | ARTICLE

HJ011



Toilet paper holder
Porta rotolo
Porte rouleaux de toilette

CODICE / COEFFICIENTE | CODE / COEFFICIENT

| | | |
|----|---------|-----|
| CC | HJ011CC | 3,5 |
| SS | HJ011SS | 4,4 |
| BO | HJ011BO | 4,4 |
| NP | HJ011NP | 4,2 |
| CF | HJ011CF | 5,3 |
| CS | HJ011CS | 5,7 |
| II | HJ011II | 5,3 |
| IS | HJ011IS | 5,7 |
| RS | HJ011RS | 5,3 |
| SR | HJ011SR | 5,7 |
| OO | HJ011OO | 5,7 |
| OS | HJ011OS | 5,3 |

PACKAGING

| | | | |
|--|------------------------------------|--|--------|
| | L: 150 mm D: 100 mm H: 70 mm | | 0,7 kg |
|--|------------------------------------|--|--------|



ARTICLE | ARTICOLO | ARTICLE

HJ009



Double robe hook
Doppio appendino a paret
Double cintre

CODICE / COEFFICIENTE | CODE / COEFFICIENT

| | | |
|----|---------|-----|
| CC | HJ009CC | 3,4 |
| SS | HJ009SS | 4,3 |
| BO | HJ009BO | 4,3 |
| NP | HJ009NP | 4,3 |
| CF | HJ009CF | 5,1 |
| CS | HJ009CS | 5,4 |
| II | HJ009II | 5,4 |
| IS | HJ009IS | 5,4 |
| RS | HJ009RS | 5,1 |
| SR | HJ009SR | 5,4 |
| OO | HJ009OO | 5,1 |
| OS | HJ009OS | 5,4 |

PACKAGING

| | | | |
|--|------------------------------------|--|--------|
| | L: 150 mm D: 100 mm H: 70 mm | | 0,4 kg |
|--|------------------------------------|--|--------|

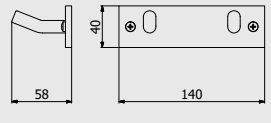

ARTICLE | ARTICOLO | ARTICLE

HJ004



Towel holder
Porta salvietta
Porte-serviette

CODICE / COEFFICIENTE | CODE / COEFFICIENT

| | | |
|----|---------|------|
| CC | HJ004CC | 7,5 |
| SS | HJ004SS | 9,4 |
| BO | HJ004BO | 9,4 |
| NP | HJ004NP | 9,4 |
| CF | HJ004CF | 11,3 |
| CS | HJ004CS | 12,0 |
| II | HJ004II | 11,3 |
| IS | HJ004IS | 12,0 |
| RS | HJ004RS | 11,3 |
| SR | HJ004SR | 12,0 |
| OO | HJ004OO | 11,3 |
| OS | HJ004OS | 12,0 |

PACKAGING

| | | | |
|--|------------------------------------|--|--------|
| | L: 782 mm D: 135 mm H: 80 mm | | 1,9 kg |
|--|------------------------------------|--|--------|

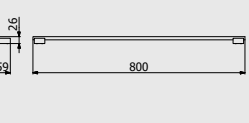

ARTICLE | ARTICOLO | ARTICLE

HJ014



Towel holder
Porta salvietta
Porte-serviette

CODICE / COEFFICIENTE | CODE / COEFFICIENT

| | | |
|----|---------|-----|
| CC | HJ014CC | 5,1 |
| SS | HJ014SS | 6,4 |
| BO | HJ014BO | 6,4 |
| NP | HJ014NP | 6,4 |
| CF | HJ014CF | 7,7 |
| CS | HJ014CS | 8,2 |
| II | HJ014II | 7,7 |
| IS | HJ014IS | 8,2 |
| RS | HJ014RS | 7,7 |
| SR | HJ014SR | 8,2 |
| OO | HJ014OO | 7,7 |
| OS | HJ014OS | 8,2 |

PACKAGING

| | | | |
|--|------------------------------------|--|--------|
| | L: 100 mm D: 100 mm H: 50 mm | | 1,1 kg |
|--|------------------------------------|--|--------|

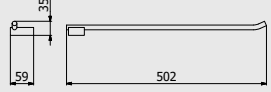

ARTICLE | ARTICOLO | ARTICLE

HJ006



Towel holder
Porta salvietta
Porte-serviette

CODICE / COEFFICIENTE | CODE / COEFFICIENT

| | | |
|----|---------|-----|
| CC | HJ006CC | 4,9 |
| SS | HJ006SS | 6,1 |
| BO | HJ006BO | 6,1 |
| NP | HJ006NP | 6,1 |
| CF | HJ006CF | 7,4 |
| CS | HJ006CS | 7,8 |
| II | HJ006II | 7,4 |
| IS | HJ006IS | 7,8 |
| RS | HJ006RS | 7,4 |
| SR | HJ006SR | 7,8 |
| OO | HJ006OO | 7,4 |
| OS | HJ006OS | 7,8 |

PACKAGING

| | | | |
|--|------------------------------------|--|--------|
| | L: 175 mm D: 125 mm H: 90 mm | | 0,9 kg |
|--|------------------------------------|--|--------|

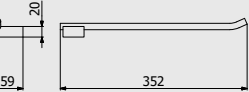

ARTICLE | ARTICOLO | ARTICLE

HJ007

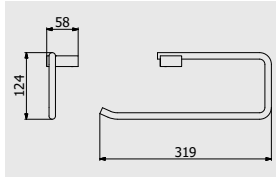

Ring Towel holder

Porta salvietta ad anello

Porte-serviette anneau

CODICE / COEFFICIENTE | CODE /
COEFFICIENT | CODE / COEFFICIENT

| | | |
|----|---------|-----|
| CC | HJ007CC | 5,0 |
| SS | HJ007SS | 6,3 |
| BO | HJ007BO | 6,3 |
| NP | HJ007NP | 6,3 |
| CF | HJ007CF | 7,5 |
| CS | HJ007CS | 8,0 |
| II | HJ007II | 7,5 |
| IS | HJ007IS | 8,0 |
| RS | HJ007RS | 7,5 |
| SR | HJ007SR | 8,0 |
| OO | HJ007OO | 7,5 |
| OS | HJ007OS | 8,0 |

PACKAGING

| | | | |
|---|-----------|---|--------|
| 📦 | L: 340 mm | 📦 | 1,9 kg |
| | D: 180 mm | | |
| | H: 70 mm | | |

ARTICLE | ARTICOLO | ARTICLE

HJ012

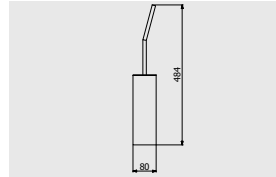

Toilet brush holder

Porta scopino da terra

Porte balayette au sol

CODICE / COEFFICIENTE | CODE /
COEFFICIENT | CODE / COEFFICIENT

| | | |
|----|---------|------|
| CC | HJ012CC | 7,8 |
| SS | HJ012SS | 9,8 |
| BO | HJ012BO | 9,8 |
| NP | HJ012NP | 9,8 |
| CF | HJ012CF | 11,7 |
| CS | HJ012CS | 12,5 |
| II | HJ012II | 11,7 |
| IS | HJ012IS | 12,5 |
| RS | HJ012RS | 11,7 |
| SR | HJ012SR | 12,5 |
| OO | HJ012OO | 11,7 |
| OS | HJ012OS | 12,5 |

PACKAGING

| | | | |
|---|-----------|---|--------|
| 📦 | L: 100 mm | 📦 | 1,8 kg |
| | D: 100 mm | | |
| | H: 50 mm | | |

ARTICLE | ARTICOLO | ARTICLE

HJ015

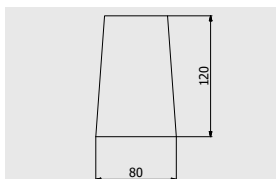

Toothbrush holder

Porta spazzolino

Porte brosse à dents

CODICE / COEFFICIENTE | CODE /
COEFFICIENT | CODE / COEFFICIENT

| | | |
|----|---------|-----|
| CC | HJ015CC | 2,8 |
|----|---------|-----|

PACKAGING

| | | | |
|---|-----------|---|--------|
| 📦 | L: 175 mm | 📦 | 0,6 kg |
| | D: 125 mm | | |
| | H: 90 mm | | |

ARTICLE | ARTICOLO | ARTICLE

HJ018

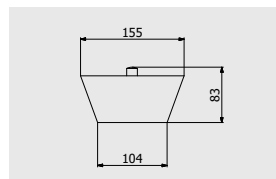

Box

Scatola

Boîte

CODICE / COEFFICIENTE | CODE /
COEFFICIENT | CODE / COEFFICIENT

| | | |
|----|---------|-----|
| CC | HJ018CC | 4,1 |
| SS | HJ018SS | 4,3 |
| BO | HJ018BO | 4,3 |
| NP | HJ018NP | 4,3 |
| CF | HJ018CF | 4,3 |
| CS | HJ018CS | 4,3 |
| II | HJ018II | 4,3 |
| IS | HJ018IS | 4,3 |
| RS | HJ018RS | 4,3 |
| SR | HJ018SR | 4,3 |
| OO | HJ018OO | 4,3 |
| OS | HJ018OS | 4,3 |

PACKAGING

| | | | |
|---|-----------|---|--------|
| 📦 | L: 240 mm | 📦 | 1,2 kg |
| | D: 215 mm | | |
| | H: 110 mm | | |





WOW

A classic can be amazing always and everywhere.

Un classico è capace di stupire sempre e ovunque.
Un classique demeure incroyable toujours et partout.

If you like something, you don't change it, at most you can only improve it. WOW is a modern reinterpretation of a bathroom design icon. The modernity of the slim clean forms is integrated respecting the classic and elegant taste that distinguishes this emblematic product, since a classic cannot be touched, but only respected in its aptitude to amaze always and everywhere.

Se qualcosa ti piace non lo cambi, al massimo lo migliori. WOW è un'interpretazione in chiave odierna di un'icona del design per il bagno. La modernità delle forme slanciate e pulite si innesta nel rispetto del gusto classico ed elegante che contraddistingue questo prodotto emblematico. Perché un classico non si tocca, lo si rispetta nella sua capacità di stupire sempre e ovunque.

Si on aime quelque chose on ne va pas le changer, au plus on cherche à l'améliorer. WOW est une interprétation actuelle d'une icône du design pour la salle de bain. La modernité des formes élancées et nettes se greffe sur le goût classique et élégant qui caractérise ce produit emblématique. Parce qu'un classique ne peut pas être touché, il doit être respecté dans sa capacité d'émerveiller toujours et partout.



ANTI-LIMESCALE
AREATOR



LEAD FREE



ZINC FREE





Wow





Wow

- ↶ W0306CC
Wall mounted widespread lavatory faucet
Rubinetto lavabo da incasso
Robinet de lavabo mural

- ↗ W0398CC
Five holes wall mounted bath filler with
shower kit
Bordo vasca a parete cinque fori con
deviatore e kit doccia
Bain cinq trous avec inverseur et Kit Douche



↑ **WO398CC**
Five holes wall mounted bath filler with shower kit
 Bordo vasca a parete cinque fori con deviatore e kit doccia
 Bain/douche 5 trous avec inverseur et Kit Douche

→ **WO410CC**
Three holes wall mounted shower with two ways diverter
 Tre rubinetti a parete per doccia con deviatore a due vie
 Melangeur trois trous douche avec inverseur deux voies

SH022CC
Duplex



Wow

ARTICLE | ARTICOLO | ARTICLE

WO205



Monohole washbasin with two handles complete with drain
Lavabo monoforo con due leve completo di scarico automatico
Mélangeur lavabo monotrou complet avec bonde automatique

CODICE / COEFFICIENTE | CODE /
COEFFICIENT | CODE / COEFFICIENT

| | | | |
|---|----|---------|------|
| ● | CC | WO205CC | 8,8 |
| ● | SS | WO205SS | 10,9 |
| ● | BO | WO205BO | 10,5 |
| ● | NP | WO205NP | 10,5 |
| ● | CF | WO205CF | 13,1 |
| ● | CS | WO205CS | 14,0 |
| ● | SR | WO205SR | 14,0 |
| ● | OO | WO205OO | 13,1 |
| ● | ON | WO205ON | 8,8 |

PACKAGING

L: 460 mm
D: 250 mm
H: 75 mm

2,2 kg

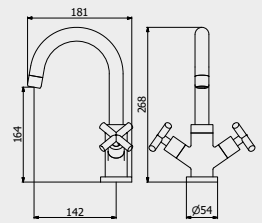

PORTATE | WATER FLOW | DÉBIT D'EAU

| | | |
|--------|--------|--------|
| 1 BAR | 2 BAR | 3 BAR |
| 10 l/m | 14 l/m | 18 l/m |

ARTICLE | ARTICOLO | ARTICLE

WO306



Wall mounted washbasin mixer complete with drain

Miscelatore lavabo tre fori a parete completo di scarico automatico
Mitigeur lavabo encastré complet avec bonde automatique

CODICE / COEFFICIENTE | CODE /
COEFFICIENT | CODE / COEFFICIENT

| | | | |
|---|----|---------|-----|
| ● | CC | WO306CC | 6,5 |
| ● | SS | WO306SS | 8,1 |
| ● | BO | WO306BO | 7,8 |
| ● | NP | WO306NP | 7,8 |
| ● | OO | WO306OO | 9,8 |

PACKAGING

L: 290 mm
D: 270 mm
H: 70 mm

2,1 kg

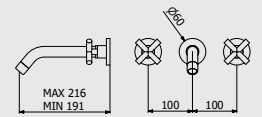

PORTATE | WATER FLOW | DÉBIT D'EAU

| | | |
|--------|--------|----------|
| 1 BAR | 2 BAR | 3 BAR |
| 11 l/m | 15 l/m | 18,5 l/m |

ARTICLE | ARTICOLO | ARTICLE

WO390



Three holes washbasin set with tall spout

Lavabo tre fori bocca alta completo di scarico automatico
Lavabo trois trous bec haut

CODICE / COEFFICIENTE | CODE /
COEFFICIENT | CODE / COEFFICIENT

| | | | |
|---|----|---------|------|
| ● | CC | WO390CC | 7,5 |
| ● | SS | WO390SS | 9,4 |
| ● | BO | WO390BO | 9,0 |
| ● | NP | WO390NP | 9,0 |
| ● | OO | WO390OO | 11,3 |

PACKAGING

L: 245 mm
D: 340 mm
H: 80 mm

2,2 kg

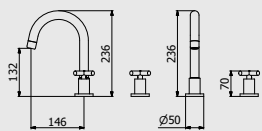

PORTATE | WATER FLOW | DÉBIT D'EAU

| | | |
|--------|--------|--------|
| 1 BAR | 2 BAR | 3 BAR |
| 14 l/m | 17 l/m | 22 l/m |

ARTICLE | ARTICOLO | ARTICLE

WO225



Monohole bidet with two handles complete with drain

Bidet monoforo con due leve completo di scarico automatico
Mélangeur bidet monotrou complet avec bonde automatique

CODICE / COEFFICIENTE | CODE /
COEFFICIENT | CODE / COEFFICIENT

| | | | |
|---|----|---------|-----|
| ● | CC | WO225CC | 6,0 |
| ● | SS | WO225SS | 7,5 |
| ● | BO | WO225BO | 7,2 |
| ● | NP | WO225NP | 7,2 |
| ● | OO | WO225OO | 9,0 |

PACKAGING

L: 220 mm
D: 290 mm
H: 80 mm

2,0 kg

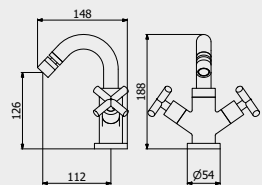

PORTATE | WATER FLOW | DÉBIT D'EAU

| | | |
|--------|--------|--------|
| 1 BAR | 2 BAR | 3 BAR |
| 13 l/m | 18 l/m | 22 l/m |



ARTICLE | ARTICOLO | ARTICLE

WO250



Wall mounted bath filler complete with hand shower kit
Bordo vasca esterno a parete completo di kit doccia
Mitigeur bain/douche mural avec douchette encastrée

| CODICE / COEFFICIENTE CODE / COEFFICIENT | |
|--|--------------------|
| COEFFICIENT | CODE / COEFFICIENT |
| ● CC | WO250CC 9,3 |
| ● SS | WO250SS 11,6 |
| ● BO | WO250BO 11,2 |
| ● NP | WO250NP 11,2 |
| ● OO | WO250OO 14,0 |

PACKAGING

| | |
|----|-------------------------------------|
| 📦 | L: 225 mm D: 170 mm H: 185 mm |
| ⚖️ | 2,6 kg |

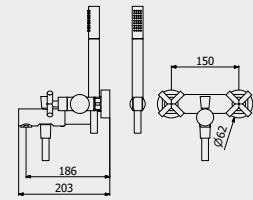

PORTATE | WATER FLOW | DÉBIT D'EAU

| 1 BAR | 2 BAR | 3 BAR |
|--------|----------|--------|
| 12 l/m | 17,1 l/m | 21 l/m |

ARTICLE | ARTICOLO | ARTICLE

WO350



Wall mounted bath filler complete with hand shower kit
Bordo vasca esterno a parete completo di kit doccia
Mitigeur bain/douche mural avec douchette encastrée

| CODICE / COEFFICIENTE CODE / COEFFICIENT | |
|--|--------------------|
| COEFFICIENT | CODE / COEFFICIENT |
| ● CC | WO350CC 6,7 |
| ● SS | WO350SS 8,4 |
| ● BO | WO350BO 8,0 |
| ● NP | WO350NP 8,0 |
| ● OO | WO350OO 10,1 |

PACKAGING

| | |
|----|-------------------------------------|
| 📦 | L: 230 mm D: 175 mm H: 160 mm |
| ⚖️ | 2,0 kg |

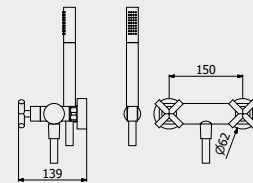

PORTATE | WATER FLOW | DÉBIT D'EAU

| 1 BAR | 2 BAR | 3 BAR |
|--------|--------|--------|
| 13 l/m | 16 l/m | 26 l/m |

ARTICLE | ARTICOLO | ARTICLE

WO400



Two holes wall mounted shower
Coppia di rubinetti a parete per doccia una via
Melangeur deux trous douche une voie

| CODICE / COEFFICIENTE CODE / COEFFICIENT | |
|--|--------------------|
| COEFFICIENT | CODE / COEFFICIENT |
| ● CC | WO400CC 8,1 |
| ● SS | WO400SS 10,1 |
| ● BO | WO400BO 9,7 |
| ● NP | WO400NP 9,7 |
| ● OO | WO400OO 12,2 |

PACKAGING

| | |
|----|------------------------------------|
| 📦 | L: 340 mm D: 180 mm H: 70 mm |
| ⚖️ | 2,3 kg |

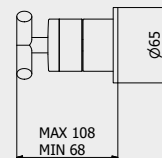

PORTATE | WATER FLOW | DÉBIT D'EAU

| 1 BAR | 2 BAR | 3 BAR |
|--------|--------|----------|
| 28 l/m | 40 l/m | 49,3 l/m |

Wow

ARTICLE | ARTICOLO | ARTICLE

WO410



Three holes wall mounted shower with two ways diverter
Tre rubinetti a parete per doccia con deviatore a due vie
Melangeur trois trous douche avec inverseur deux voies

| CODICE / COEFFICIENTE CODE / COEFFICIENT | |
|--|--------------------|
| COEFFICIENT | CODE / COEFFICIENT |
| ● CC | WO410CC 13,6 |
| ● SS | WO410SS 17,0 |
| ● BO | WO410BO 16,3 |
| ● NP | WO410NP 16,3 |
| ● OO | WO410OO 20,4 |

PACKAGING

| | |
|----|------------------------------------|
| 📦 | L: 340 mm D: 180 mm H: 70 mm |
| ⚖️ | 2,3 kg |

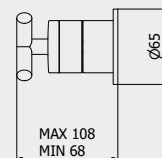

PORTATE | WATER FLOW | DÉBIT D'EAU

| 1 BAR | 2 BAR | 3 BAR |
|--------|----------|----------|
| 16 l/m | 22,4 l/m | 27,4 l/m |

ARTICLE | ARTICOLO | ARTICLE

W0700



Free-standing bath filler with shower kit

Bordo vasca da terra con kit doccia

Bain douche complet alimentation au sol

CODICE / COEFFICIENTE | CODE /
COEFFICIENT | CODE / COEFFICIENT

| | | | |
|---|----|---------|------|
| ● | CC | W0700CC | 39,6 |
| ● | SS | W0700SS | 49,5 |
| ● | BO | W0700BO | 47,5 |
| ● | NP | W0700NP | 47,5 |
| ● | OO | W0700OO | 59,4 |

PACKAGING

 L: 360 mm
D: 220 mm
H: 150 mm

 L: 200 mm
D: 200 mm
H: 150 mm

7,9 kg

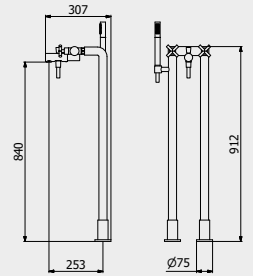

PORTATE | WATER FLOW | DÉBIT D'EAU

| | | |
|--------|--------|--------|
| 1 BAR | 2 BAR | 3 BAR |
| 20 l/m | 26 l/m | 32 l/m |

ARTICLE | ARTICOLO | ARTICLE

W0320



Wall mounted spout

Bocca d'erogazione a parete

Bec de remplissage mural

CODICE / COEFFICIENTE | CODE /
COEFFICIENT | CODE / COEFFICIENT

| | | | |
|---|----|---------|-----|
| ● | CC | W0320CC | 2,1 |
| ● | SS | W0320SS | 2,6 |
| ● | BO | W0320BO | 2,5 |
| ● | NP | W0320NP | 2,5 |
| ● | OO | W0320OO | 3,2 |

PACKAGING

 L: 175 mm
D: 125 mm
H: 90 mm

0,2 kg

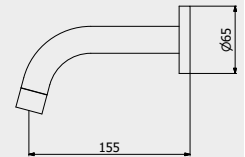

PORTATE | WATER FLOW | DÉBIT D'EAU

| | | |
|--------|--------|--------|
| 1 BAR | 2 BAR | 3 BAR |
| 10 l/m | 14 l/m | 17 l/m |

ARTICLE | ARTICOLO | ARTICLE

W0321



Short wall mounted spout

Bocca d'erogazione corta a parete

Bec de remplissage mural court

CODICE / COEFFICIENTE | CODE /
COEFFICIENT | CODE / COEFFICIENT

| | | | |
|---|----|---------|-----|
| ● | CC | W0321CC | 2,5 |
| ● | SS | W0321SS | 3,1 |
| ● | BO | W0321BO | 3,0 |
| ● | NP | W0321NP | 3,0 |
| ● | OO | W0321OO | 3,8 |

PACKAGING

 L: 175 mm
D: 125 mm
H: 90 mm

0,2 kg

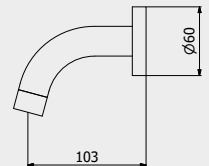

PORTATE | WATER FLOW | DÉBIT D'EAU

| | | |
|--------|--------|--------|
| 1 BAR | 2 BAR | 3 BAR |
| 10 l/m | 14 l/m | 17 l/m |

ARTICLE | ARTICOLO | ARTICLE

MT322



Long wall mounted spout

Bocca d'erogazione lunga a parete

Bec de remplissage mural long

CODICE / COEFFICIENTE | CODE /
COEFFICIENT | CODE / COEFFICIENT

| | | | |
|---|----|---------|-----|
| ● | CC | MT322CC | 2,5 |
| ● | SS | MT322SS | 3,1 |
| ● | BO | MT322BO | 3,0 |
| ● | NP | MT322NP | 3,0 |
| ● | OO | MT322OO | 3,8 |

PACKAGING

 L: 175 mm
D: 125 mm
H: 90 mm

0,2 kg

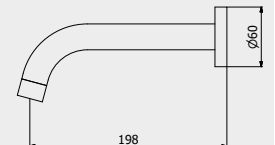

PORTATE | WATER FLOW | DÉBIT D'EAU

| | | |
|--------|--------|--------|
| 1 BAR | 2 BAR | 3 BAR |
| 10 l/m | 14 l/m | 17 l/m |



MODERNA / ACCESSORIES COLLECTION

ARTICLE | ARTICOLO | ARTICLE

MO001

Wall soap-holder

Porta sapone a muro
Porte distributeur de savon encastré

CODE / COEFFICIENT | CODICE /
COEFFICIENTE | CODE / COEFFICIENT

CC MO001CC 1,5

PACKAGING

L: 110 mm
D: 130 mm
H: 50 mm

0,4 kg

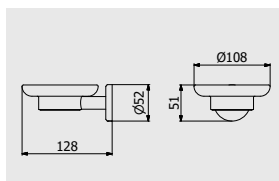

ARTICLE | ARTICOLO | ARTICLE

MO002

Wall soap dispenser holder

Porta dispenser sapone liquido a parete
Porte distributeur de savon en verre gravé

CODE / COEFFICIENT | CODICE /
COEFFICIENTE | CODE / COEFFICIENT

CC MO002CC 2,3

PACKAGING

L: 80 mm
D: 130 mm
H: 180 mm

0,1 kg

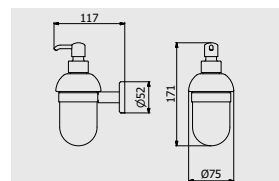

ARTICLE | ARTICOLO | ARTICLE

MO003

Wall toothbrush holder

Bicchiera porta spazzolino a parete
Porte-verre en verre gravé

CODE / COEFFICIENT | CODICE /
COEFFICIENTE | CODE / COEFFICIENT

CC MO003CC 1,5

PACKAGING

L: 70 mm
D: 110 mm
H: 100 mm

0,4 kg

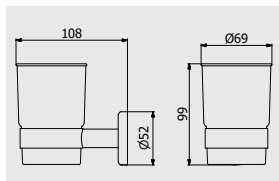

ARTICLE | ARTICOLO | ARTICLE

MO004

Towel holder

Porta salvietta
Porte-serviette

CODE / COEFFICIENT | CODICE /
COEFFICIENTE | CODE / COEFFICIENT

CC MO004CC 2,4

PACKAGING

L: 650 mm
D: 70 mm
H: 50 mm

0,5 kg

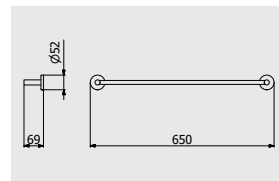

ARTICLE | ARTICOLO | ARTICLE

MO014

Towel holder

Porta salvietta
Porte-serviette

CODE / COEFFICIENT | CODICE /
COEFFICIENTE | CODE / COEFFICIENT

CC MO014CC 2,2

PACKAGING

L: 500 mm
D: 70 mm
H: 50 mm

0,5 kg

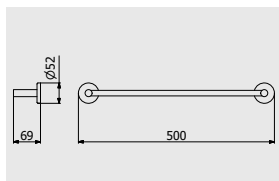

ARTICLE | ARTICOLO | ARTICLE

MO006

Towel holder

Porta salvietta
Porte-serviette

CODE / COEFFICIENT | CODICE /
COEFFICIENTE | CODE / COEFFICIENT

CC MO006CC 2,1

PACKAGING

L: 350 mm
D: 70 mm
H: 50 mm

0,4 kg

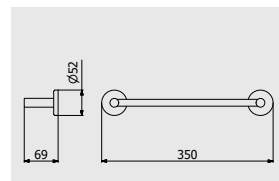

Wow

ARTICLE | ARTICOLO | ARTICLE

M0007



Ring Towel holder

Porta salvietta ad anello

Porte-serviette anneau

CODE / COEFFICIENT | CODICE /
COEFFICIENTE | CODE / COEFFICIENT

CC M0007CC 1,6

PACKAGING

L: 180 mm
D: 70 mm
H: 200 mm

0,8 kg

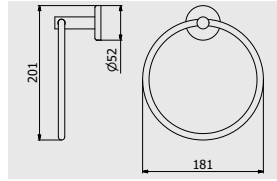

ARTICLE | ARTICOLO | ARTICLE

M0008



Robe Hook

Appendino a parete

Cintre

CODE / COEFFICIENT | CODICE /
COEFFICIENTE | CODE / COEFFICIENT

CC M0008CC 0,9

PACKAGING

L: 50 mm
D: 50 mm
H: 50 mm

0,3 kg

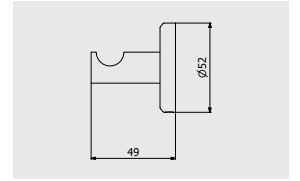

ARTICLE | ARTICOLO | ARTICLE

M0009



Double robe hook

Doppio appendino a parete

Double cintre

CODE / COEFFICIENT | CODICE /
COEFFICIENTE | CODE / COEFFICIENT

CC M0009CC 1,4

PACKAGING

L: 70 mm
D: 70 mm
H: 50 mm

0,1 kg

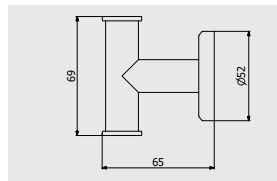

ARTICLE | ARTICOLO | ARTICLE

M0010



Shelf

Mensola

Etagère

CODE / COEFFICIENT | CODICE /
COEFFICIENTE | CODE / COEFFICIENT

CC M0010CC 3,0

PACKAGING

L: 600 mm
D: 140 mm
H: 50 mm

0,3 kg

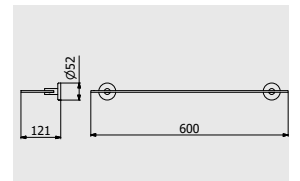

ARTICLE | ARTICOLO | ARTICLE

M0005



Swiveable towel holder

Porta salvietta doppio

Porte-serviette noeud

CODE / COEFFICIENT | CODICE /
COEFFICIENTE | CODE / COEFFICIENT

CC M0005CC 3,5

PACKAGING

L: 430 mm
D: 70 mm
H: 50 mm

0,5 kg

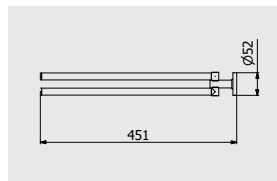

ARTICLE | ARTICOLO | ARTICLE

M0011



Toilet paper holder

Porta rotolo

Porte rouleaux de toilette

CODE / COEFFICIENT | CODICE /
COEFFICIENTE | CODE / COEFFICIENT

CC M0011CC 1,4

PACKAGING

L: 150 mm
D: 70 mm
H: 50 mm

0,2 kg

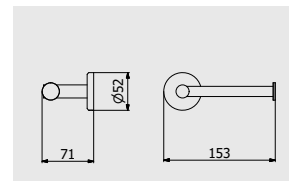

ARTICLE | ARTICOLO | ARTICLE

M0012



Toilet brush holder

Porta scopino da terra

Porte balayette au sol

CODE / COEFFICIENT | CODICE /
COEFFICIENTE | CODE / COEFFICIENT

CC M0012CC 2,5

PACKAGING

L: 80 mm
D: 80 mm
H: 380 mm

0,7 kg

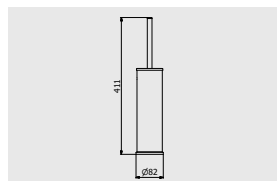

ARTICLE | ARTICOLO | ARTICLE

M0013



Wall toilet brush holder

Porta scopino da parete

Porte balayette

CODE / COEFFICIENT | CODICE /
COEFFICIENTE | CODE / COEFFICIENT

CC M0013CC 2,9

PACKAGING

L: 80 mm
D: 80 mm
H: 380 mm

0,7 kg

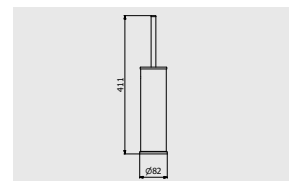

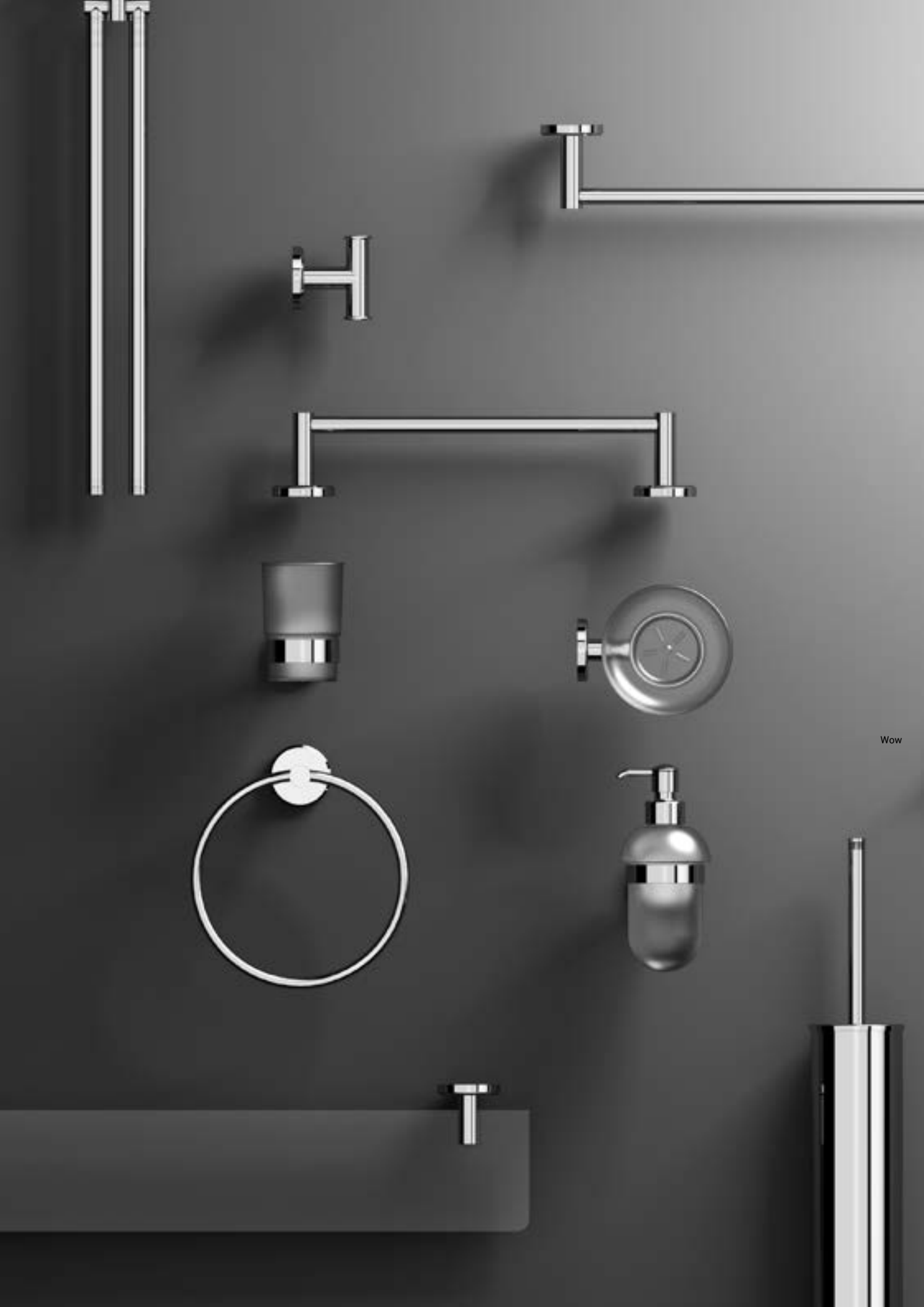

Wow

BIRKIN

Diamonds are a girl's best friends.

I diamanti sono i migliori amici di una ragazza.
Les diamants sont les meilleurs amis d'une fille.

From the name of a 1970s fashion icon, the BIRKIN collection pays tribute to this inspiring muse through a range of products that recall her elegance and strong personality. Birkin offers two selections of spout, simple or engraved with wooden decorations, and three levers, in Swarovski crystal, white Carrara marble or black Marquinia marble, in order to enhance luxurious bathrooms with strong personality through unique and elegant materials.

Dal nome di un'icona dell'eleganza anni Settanta, la collezione BIRKIN omaggia questa musa ispiratrice attraverso una gamma di prodotti che ne richiamano l'eleganza e la decisa personalità. Birkin offre due gamme di bocche, semplice o incisa con decorazioni lignee, e tre leve, in cristallo Swarovski, marmo bianco di Carrara o marmo nero di Marquinia, a impreziosire con materiali unici ed eleganti dei bagni sfarzosi, dotati di forte personalità.

Du nom d'une icône de l'élégance des années 1970, la collection BIRKIN rend hommage à cette muse inspiratrice à travers une gamme de produits qui en rappellent l'élégance et la forte personnalité. Birkin offre deux gammes de becs, simple ou gravée avec des décorations en bois, et trois leviers, en cristal Swarovski, en marbre blanc de Carrare ou en marbre noir de Marquinia, qui embellissent, avec des matériaux uniques, des salles de bain luxueuses à la forte personnalité.



ANTI-LIMESCALE
AREATOR



DOUBLE LEVER



LEAD FREE



ZINC FREE





Birkin

DESIGN
CAMILLA MARIONI



↑ **BR205CC_3**
Monohole washbasin with two handles
Lavabo monoforo con due leve
Mélangeur Lavabo Monotrou

→ **BR205CC_2**
Monohole washbasin with two handles
Lavabo monoforo con due leve
Mélangeur Lavabo Monotrou



Birkin



↑ BR390CC_3
Three holes washbasin set with tall spout
Lavabo tre fori bocca alta
lavabo trois trous bec haut

→ BN390CC_1
Three holes washbasin set with tall spout
Lavabo tre fori bocca alta
lavabo trois trous bec haut



Birkin



↑ BR220CC_1
Monohole bidet mixer
Miscelatore bidet monoforo
Mitigeur bidet

→ BR390CC_2
Three holes washbasin set with tall spout
Lavabo tre fori bocca alta
lavabo trois trous bec haut



ARTICLE | ARTICOLO | ARTICLE

BR205_1



Monohole washbasin mixer complete with drain
 Miscelatore lavabo monoforo completo di scarico automatico
 Mitigeur lavabo complet avec bonde automatique

| CODICE / COEFFICIENTE CODE / COEFFICIENT | |
|--|----------------|
| ● CC | BR205CC_1 13,7 |
| ● PL | BR205PL_1 21,9 |
| ● SS | BR205SS_1 17,1 |
| ● RS | BR205RS_1 20,6 |
| ● OS | BR205OS_1 21,9 |

PACKAGING

| | |
|---|-------------------------------------|
| 📦 | L: 353 mm D: 225 mm H: 226 mm |
| 📊 | 3,5 kg |

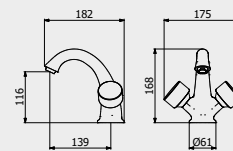

PORTATE | WATER FLOW | DÉBIT D'EAU

| 1 BAR | 2 BAR | 3 BAR |
|----------|----------|----------|
| 10,3 l/m | 14,7 l/m | 18,2 l/m |

ARTICLE | ARTICOLO | ARTICLE

BR205_2



Monohole washbasin mixer complete with drain
 Miscelatore lavabo monoforo completo di scarico automatico
 Mitigeur lavabo complet avec bonde automatique

| CODICE / COEFFICIENTE CODE / COEFFICIENT | |
|--|----------------|
| ● CC | BR205CC_2 13,7 |
| ● PL | BR205PL_2 21,9 |
| ● SS | BR205SS_2 17,1 |
| ● RS | BR205RS_2 20,6 |
| ● OS | BR205OS_2 21,9 |

PACKAGING

| | |
|---|-------------------------------------|
| 📦 | L: 353 mm D: 225 mm H: 226 mm |
| 📊 | 3,5 kg |

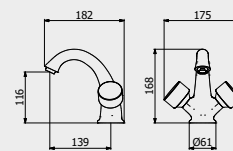

PORTATE | WATER FLOW | DÉBIT D'EAU

| 1 BAR | 2 BAR | 3 BAR |
|----------|----------|----------|
| 10,3 l/m | 14,7 l/m | 18,2 l/m |

ARTICLE | ARTICOLO | ARTICLE

BR205_3



Monohole washbasin mixer complete with drain
 Miscelatore lavabo monoforo completo di scarico automatico
 Mitigeur lavabo complet avec bonde automatique

| CODICE / COEFFICIENTE CODE / COEFFICIENT | |
|--|----------------|
| ● CC | BR205CC_3 15,6 |
| ● PL | BR205PL_3 25,0 |
| ● SS | BR205SS_3 19,5 |
| ● RS | BR205RS_3 23,4 |
| ● OS | BR205OS_3 25,0 |

PACKAGING

| | |
|---|-------------------------------------|
| 📦 | L: 353 mm D: 225 mm H: 226 mm |
| 📊 | 3,5 kg |

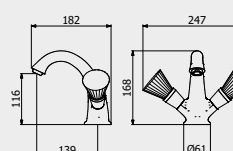

PORTATE | WATER FLOW | DÉBIT D'EAU

| 1 BAR | 2 BAR | 3 BAR |
|----------|----------|----------|
| 10,3 l/m | 14,7 l/m | 18,2 l/m |

Birkin

ARTICLE | ARTICOLO | ARTICLE

BR306_1



Three holes washbasin set with low spout

Lavabo tre fori a bocca bassa completo di scarico automatico

Lavabo trois trous bec bas

CODICE / COEFFICIENTE | CODE /
COEFFICIENT | CODE / COEFFICIENT

| | | | |
|---|----|-----------|------|
| ● | CC | BR306CC_1 | 18,3 |
| ● | PL | BR306PL_1 | 29,2 |
| ● | SS | BR306SS_1 | 22,8 |
| ● | RS | BR306RS_1 | 27,4 |
| ● | OS | BR306OS_1 | 29,2 |

PACKAGING

L: 350 mm
D: 270 mm
H: 35 mm

3,5 kg

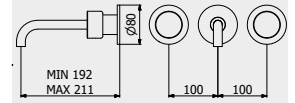

PORTATE | WATER FLOW | DÉBIT D'EAU

| | | |
|---------|---------|---------|
| 1 BAR | 2 BAR | 3 BAR |
| 2,4 l/m | 3,8 l/m | 3,8 l/m |

ARTICLE | ARTICOLO | ARTICLE

BR306_2



Three holes washbasin set with low spout

Lavabo tre fori a bocca bassa completo di scarico automatico

Lavabo trois trous bec bas

CODICE / COEFFICIENTE | CODE /
COEFFICIENT | CODE / COEFFICIENT

| | | | |
|---|----|-----------|------|
| ● | CC | BR306CC_2 | 18,3 |
| ● | PL | BR306PL_2 | 29,2 |
| ● | SS | BR306SS_2 | 22,8 |
| ● | RS | BR306RS_2 | 27,4 |
| ● | OS | BR306OS_2 | 29,2 |

PACKAGING

L: 350 mm
D: 270 mm
H: 35 mm

3,5 kg

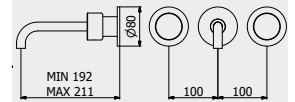

PORTATE | WATER FLOW | DÉBIT D'EAU

| | | |
|---------|---------|---------|
| 1 BAR | 2 BAR | 3 BAR |
| 2,4 l/m | 3,8 l/m | 3,8 l/m |

ARTICLE | ARTICOLO | ARTICLE

BR306_3



Three holes washbasin set with low spout

Lavabo tre fori a bocca bassa completo di scarico automatico

Lavabo trois trous bec bas

CODICE / COEFFICIENTE | CODE /
COEFFICIENT | CODE / COEFFICIENT

| | | | |
|---|----|-----------|------|
| ● | CC | BR306CC_3 | 21,9 |
| ● | SS | BR306SS_3 | 27,3 |
| ● | PL | BR306PL_3 | 35 |
| ● | RS | BR306RS_3 | 32,8 |
| ● | OS | BR306OS_3 | 35,0 |

PACKAGING

L: 350 mm
D: 270 mm
H: 35 mm

3,5 kg

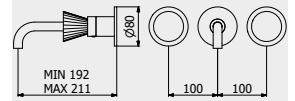

PORTATE | WATER FLOW | DÉBIT D'EAU

| | | |
|---------|---------|---------|
| 1 BAR | 2 BAR | 3 BAR |
| 2,4 l/m | 3,8 l/m | 3,8 l/m |



ARTICLE | ARTICOLO | ARTICLE

BR390_1



Three holes washbasin set with tall spout

Lavabo tre fori bocca alta completo di scarico automatico

Lavabo trois trous bec haut

| CODICE / COEFFICIENTE CODE / COEFFICIENT | |
|--|----------------|
| CC | BR390CC_1 18,4 |
| PL | BR390PL_1 29,4 |
| SS | BR390SS_1 23,0 |
| RS | BR390RS_1 27,6 |
| OS | BR390OS_1 29,4 |

PACKAGING

L: 470 mm
 D: 290 mm
 H: 160 mm

 4,5 kg

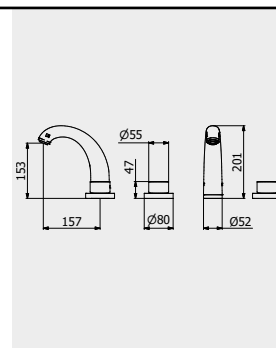

PORTATE | WATER FLOW | DÉBIT D'EAU

| 1 BAR | 2 BAR | 3 BAR |
|----------|--------|----------|
| 11,1 l/m | 16 l/m | 19,8 l/m |

ARTICLE | ARTICOLO | ARTICLE

BR390_2



Three holes washbasin set with tall spout

Lavabo tre fori bocca alta completo di scarico automatico

Lavabo trois trous bec haut

| CODICE / COEFFICIENTE CODE / COEFFICIENT | |
|--|----------------|
| CC | BR390CC_2 18,4 |
| PL | BR390PL_2 29,4 |
| SS | BR390SS_2 23,0 |
| RS | BR390RS_2 27,6 |
| OS | BR390OS_2 29,4 |

PACKAGING

L: 470 mm
 D: 290 mm
 H: 160 mm

 4,5 kg

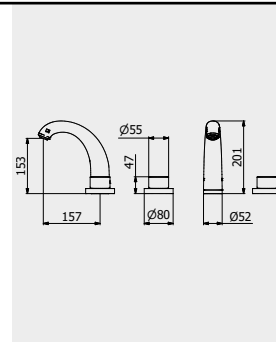

PORTATE | WATER FLOW | DÉBIT D'EAU

| 1 BAR | 2 BAR | 3 BAR |
|----------|--------|----------|
| 11,1 l/m | 16 l/m | 19,8 l/m |

ARTICLE | ARTICOLO | ARTICLE

BR390_3



Three holes washbasin set with tall spout

Lavabo tre fori bocca alta completo di scarico automatico

Lavabo trois trous bec haut

| CODICE / COEFFICIENTE CODE / COEFFICIENT | |
|--|----------------|
| CC | BR390CC_3 21,1 |
| PL | BR390PL_3 33,8 |
| SS | BR390SS_3 26,4 |
| RS | BR390RS_3 31,7 |
| OS | BR390OS_3 33,8 |

PACKAGING

L: 470 mm
 D: 290 mm
 H: 160 mm

 4,5 kg

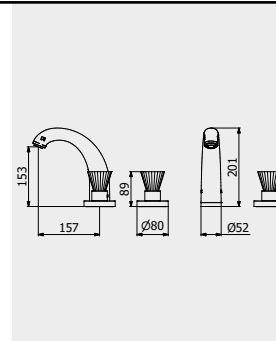

PORTATE | WATER FLOW | DÉBIT D'EAU

| 1 BAR | 2 BAR | 3 BAR |
|----------|--------|----------|
| 11,1 l/m | 16 l/m | 19,8 l/m |

Birkin

ARTICLE | ARTICOLO | ARTICLE

BN390_1



Three holes washbasin set with tall spout

Lavabo tre fori bocca alta completo di scarico automatico

Lavabo trois trous bec haut

CODICE / COEFFICIENTE | CODE /
COEFFICIENT | CODE / COEFFICIENT

| | | | |
|---|----|-----------|------|
| ● | CC | BN390CC_1 | 21,3 |
| ● | PL | BN390PL_1 | 34,1 |
| ● | SS | BN390SS_1 | 26,6 |
| ● | RS | BN390RS_1 | 32,0 |
| ● | OS | BN390OS_1 | 34,1 |

PACKAGING

L: 470 mm
D: 290 mm
H: 160 mm

4,5 kg

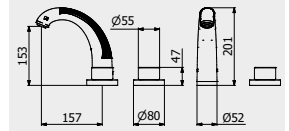

PORTATE | WATER FLOW | DÉBIT D'EAU

| | | |
|----------|--------|----------|
| 1 BAR | 2 BAR | 3 BAR |
| 11,1 l/m | 16 l/m | 19,8 l/m |

ARTICLE | ARTICOLO | ARTICLE

BN390_2



Three holes washbasin set with tall spout

Lavabo tre fori bocca alta completo di scarico automatico

Lavabo trois trous bec haut

CODICE / COEFFICIENTE | CODE /
COEFFICIENT | CODE / COEFFICIENT

| | | | |
|---|----|-----------|------|
| ● | CC | BN390CC_2 | 21,3 |
| ● | PL | BN390PL_2 | 34,1 |
| ● | SS | BN390SS_2 | 26,6 |
| ● | RS | BN390RS_2 | 32,0 |
| ● | OS | BN390OS_2 | 34,1 |

PACKAGING

L: 470 mm
D: 290 mm
H: 160 mm

4,5 kg

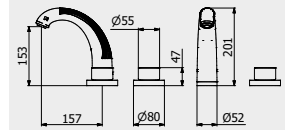

PORTATE | WATER FLOW | DÉBIT D'EAU

| | | |
|----------|--------|----------|
| 1 BAR | 2 BAR | 3 BAR |
| 11,1 l/m | 16 l/m | 19,8 l/m |

ARTICLE | ARTICOLO | ARTICLE

BN390_3



Three holes washbasin set with tall spout

Lavabo tre fori bocca alta completo di scarico automatico

Lavabo trois trous bec haut

CODICE / COEFFICIENTE | CODE /
COEFFICIENT | CODE / COEFFICIENT

| | | | |
|---|----|-----------|------|
| ● | CC | BN390CC_3 | 24,0 |
| ● | PL | BN390PL_3 | 38,4 |
| ● | SS | BN390SS_3 | 30,0 |
| ● | RS | BN390RS_3 | 36,0 |
| ● | OS | BN390OS_3 | 38,4 |

PACKAGING

L: 470 mm
D: 290 mm
H: 160 mm

4,5 kg

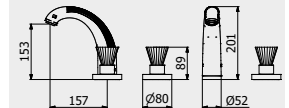

PORTATE | WATER FLOW | DÉBIT D'EAU

| | | |
|----------|--------|----------|
| 1 BAR | 2 BAR | 3 BAR |
| 11,1 l/m | 16 l/m | 19,8 l/m |



ARTICLE | ARTICOLO | ARTICLE

BR225_1



Monohole bidet mixer complete with drain

Bidet monoforo con scarico automatico

Mitigeur bidet complet avec bonde automatique

| CODICE / COEFFICIENTE | CODE / COEFFICIENT | |
|-----------------------|--------------------|------|
| CC | BR225CC_1 | 13,5 |
| PL | BR225PL_1 | 21,6 |
| SS | BR225SS_1 | 16,9 |
| RS | BR225RS_1 | 20,3 |
| OS | BR225OS_1 | 21,6 |

PACKAGING

L: 353 mm
D: 225 mm
H: 226 mm

3,5kg

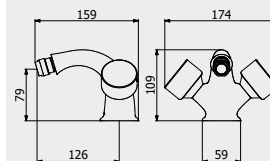

PORTATE | WATER FLOW | DÉBIT D'EAU

| 1 BAR | 2 BAR | 3 BAR |
|----------|----------|----------|
| 10,3 l/m | 14,7 l/m | 18,2 l/m |

ARTICLE | ARTICOLO | ARTICLE

BR225_2



Monohole bidet mixer complete with drain

Bidet monoforo con scarico automatico

Mitigeur bidet complet avec bonde automatique

| CODICE / COEFFICIENTE | CODE / COEFFICIENT | |
|-----------------------|--------------------|------|
| CC | BR225CC_2 | 13,5 |
| PL | BR225PL_2 | 21,6 |
| SS | BR225SS_2 | 16,9 |
| RS | BR225RS_2 | 20,3 |
| OS | BR225OS_2 | 21,6 |

PACKAGING

L: 353 mm
D: 225 mm
H: 226 mm

3,5 kg

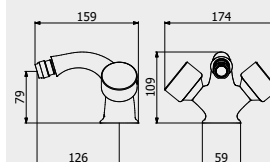

PORTATE | WATER FLOW | DÉBIT D'EAU

| 1 BAR | 2 BAR | 3 BAR |
|----------|----------|----------|
| 10,3 l/m | 14,7 l/m | 18,2 l/m |

ARTICLE | ARTICOLO | ARTICLE

BR225_3



Monohole bidet mixer complete with drain

Bidet monoforo con scarico automatico

Mitigeur bidet complet avec bonde automatique

| CODICE / COEFFICIENTE | CODE / COEFFICIENT | |
|-----------------------|--------------------|------|
| CC | BR225CC_2 | 15,4 |
| PL | BR225PL_2 | 24,6 |
| SS | BR225SS_2 | 19,3 |
| RS | BR225RS_2 | 23,1 |
| OS | BR225OS_2 | 24,6 |

PACKAGING

L: 353 mm
D: 225 mm
H: 226 mm

3,5 kg

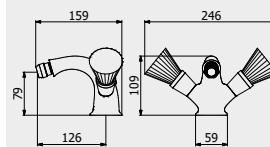

PORTATE | WATER FLOW | DÉBIT D'EAU

| 1 BAR | 2 BAR | 3 BAR |
|----------|----------|----------|
| 10,3 l/m | 14,7 l/m | 18,2 l/m |

Birkin

ARTICLE | ARTICOLO | ARTICLE

BR396_1



Five holes deck mounted bath filler with shower kit

Bordo vasca cinque fori con deviatore e kit doccia

Bain cinq trous avec inverseur et Kit Douche

CODICE / COEFFICIENTE | CODE /
COEFFICIENT | CODE / COEFFICIENT

| | | | |
|---|----|-----------|------|
| ● | CC | BR396CC_1 | 33,1 |
| ● | SS | BR396SS_1 | 41,4 |
| ● | PL | BR396PL_1 | 53,0 |
| ● | RS | BR396RS_1 | 49,7 |
| ● | OS | BR396OS_1 | 53,0 |

PACKAGING

L: 685 mm
D: 345 mm
H: 168 mm

11,4 kg

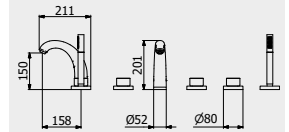

PORTATE | WATER FLOW | DÉBIT D'EAU

| | | |
|----------|----------|----------|
| 1 BAR | 2 BAR | 3 BAR |
| 13,7 l/m | 19,6 l/m | 24,1 l/m |

ARTICLE | ARTICOLO | ARTICLE

BR396_2



Five holes deck mounted bath filler with shower kit

Bordo vasca cinque fori con deviatore e kit doccia

Bain cinq trous avec inverseur et Kit Douche

CODICE / COEFFICIENTE | CODE /
COEFFICIENT | CODE / COEFFICIENT

| | | | |
|---|----|-----------|------|
| ● | CC | BR396CC_2 | 33,1 |
| ● | SS | BR396SS_2 | 41,4 |
| ● | PL | BR396PL_2 | 53,0 |
| ● | RS | BR396RS_2 | 49,7 |
| ● | OS | BR396OS_2 | 53,0 |

PACKAGING

L: 685 mm
D: 345 mm
H: 168 mm

11,4 kg

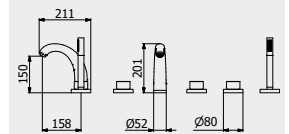

PORTATE | WATER FLOW | DÉBIT D'EAU

| | | |
|----------|----------|----------|
| 1 BAR | 2 BAR | 3 BAR |
| 13,7 l/m | 19,6 l/m | 24,1 l/m |

ARTICLE | ARTICOLO | ARTICLE

BR396_3



Five holes deck mounted bath filler with shower kit

Bordo vasca cinque fori con deviatore e kit doccia

Bain cinq trous avec inverseur et Kit Douche

CODICE / COEFFICIENTE | CODE /
COEFFICIENT | CODE / COEFFICIENT

| | | | |
|---|----|-----------|------|
| ● | CC | BR396CC_3 | 37,5 |
| ● | SS | BR396SS_3 | 46,9 |
| ● | PL | BR396PL_3 | 60,0 |
| ● | RS | BR396RS_3 | 56,3 |
| ● | OS | BR396OS_3 | 60,0 |

PACKAGING

L: 685 mm
D: 345 mm
H: 168 mm

11,4 kg

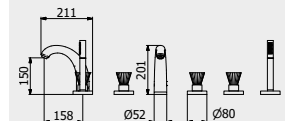

PORTATE | WATER FLOW | DÉBIT D'EAU

| | | |
|----------|----------|----------|
| 1 BAR | 2 BAR | 3 BAR |
| 13,7 l/m | 19,6 l/m | 24,1 l/m |



ARTICLE | ARTICOLO | ARTICLE

BN396_1



Five holes deck mounted bath filler with shower kit

Bordo vasca cinque fori con deviatore e kit doccia

Bain cinq trous avec inverseur et kit douche

| CODICE / COEFFICIENTE | CODE / COEFFICIENT | |
|-----------------------|--------------------|------|
| CC | BN396CC_1 | 35,0 |
| SS | BN396SS_1 | 43,8 |
| PL | BN396PL_1 | 56,0 |
| RS | BN396RS_1 | 52,5 |
| OS | BN396OS_1 | 56,0 |

PACKAGING

L: 685 mm
D: 345 mm
H: 168 mm

11,4 kg

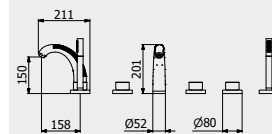

PORTATE | WATER FLOW | DÉBIT D'EAU

| 1 BAR | 2 BAR | 3 BAR |
|----------|----------|----------|
| 13,7 l/m | 19,6 l/m | 24,1 l/m |

ARTICLE | ARTICOLO | ARTICLE

BN396_2



Five holes deck mounted bath filler with shower kit

Bordo vasca cinque fori con deviatore e kit doccia

Bain cinq trous avec inverseur et Kit Douche

| CODICE / COEFFICIENTE | CODE / COEFFICIENT | |
|-----------------------|--------------------|------|
| CC | BN396CC_2 | 35,0 |
| SS | BN396SS_2 | 43,8 |
| PL | BN396PL_2 | 56,0 |
| RS | BN396RS_2 | 52,5 |
| OS | BN396OS_2 | 56,0 |

PACKAGING

L: 685 mm
D: 345 mm
H: 168 mm

11,4 kg

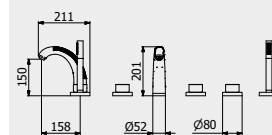

PORTATE | WATER FLOW | DÉBIT D'EAU

| 1 BAR | 2 BAR | 3 BAR |
|----------|----------|----------|
| 13,7 l/m | 19,6 l/m | 24,1 l/m |

ARTICLE | ARTICOLO | ARTICLE

BN396_3



Five holes deck mounted bath filler with shower kit

Bordo vasca cinque fori con deviatore e kit doccia

Bain cinq trous avec inverseur et Kit Douche

| CODICE / COEFFICIENTE | CODE / COEFFICIENT | |
|-----------------------|--------------------|------|
| CC | BN396CC_3 | 40,6 |
| SS | BN396SS_3 | 50,8 |
| PL | BN396PL_3 | 65,0 |
| RS | BN396RS_3 | 60,9 |
| OS | BN396OS_3 | 65,0 |

PACKAGING

L: 685 mm
D: 345 mm
H: 168 mm

11,4 kg

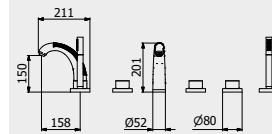

PORTATE | WATER FLOW | DÉBIT D'EAU

| 1 BAR | 2 BAR | 3 BAR |
|----------|----------|----------|
| 13,7 l/m | 19,6 l/m | 24,1 l/m |

Birkin

HERMES / HERMES ELLE

**The true classic will be
current even in a hundred
years.**

Il vero classico è sempre attuale anche dopo cent'anni.
Le vrai classique sera d'actualité même dans cent ans.

True eternal classic of faucet design, Hermes recaptures and enhances the traditional forms of the faucet, providing a familiar decorative element, adaptable to both classic and contemporary settings. The wide range of products, especially in the rich shower section, is completed by two different levers, a more baroque and traditional one, and another with more feminine and delicate features.

Vero classico eterno del design di rubinetti, Hermes riprende e arricchisce le forme tradizionali del rubinetto, fornendo un elemento decorativo familiare, adattabile ad ambienti sia classici che contemporanei. La vasta gamma di prodotti, soprattutto nella ricca sezione doccia, è completata da due differenti leve, dal tratto più barocco e tradizionale o dalle fattezze più femmine e delicate.

Véritable classique du design des robinets, Hermes capture et enrichit les formes traditionnelles du robinet, en fournissant un élément décoratif familier, adaptable tant aux environnements classiques qu'à ceux plus contemporains. La vaste gamme de produits, en particulier dans la riche section douche, est complétée par deux leviers différents, l'un avec une touche plus baroque et traditionnelle, l'autre avec des traits plus féminins et délicats.



KITCHEN
AVAILABLE



DOUBLE
HANDLES



LEAD FREE



ZINC FREE





Hermes

DESIGN
ELIO BREGOLI



- ↑ **HR390CC**
 Three holes washbasin set with tall spout
 Lavabo tre fori bocca alta
 Lavabo trois trous bec haut
- ↙ **HL390II_2**
 Three holes washbasin set with tall spout
 Lavabo tre fori bocca alta
 Lavabo trois trous bec haut
- **HR205CC**
 Monohole washbasin with two handles
 Lavabo monoforo con due leve
 Mélangeur lavabo monotrou









↑ HL393CC_2
Three holes bidet set
 Bidet tre fori con bocca snodabile
 Bidet trois trous

← HR225CC
Monohole bidet with two handles
 Bidet monoforo con due leve
 Mélangeur Bidet monotrou

→ HR250CC
 Wall mounted bath filler with hand shower kit
 Bordo vasca esterno a parete con kit doccia
 Mitigeur Bain/douche Mural avec douchette
 encastrée





- ↖ **HR350CC**
Wall mounted shower mixer with shower kit
Doccia esterno a parete con kit doccia
Mitigeur de douche externe avec flexible et
douchette

- ← **HL199CC**
Shower column with thermostatic
Colonna doccia con termostatico e soffione
Colonne de douche thermostatique

- A Thermostatic valve**
Valvola termostatica
Valve thermostatique
- B Flow control**
Regolazione del flusso
Régulation de débit

- ↗ **HL851CC_2**
Thermostatic shower column with shower kit
Colonna doccia con miscelatore termostatico
e kit doccia
Colonne douche thermostatique et kit douche



Hermes

LEVER | LEVA | LEVIER

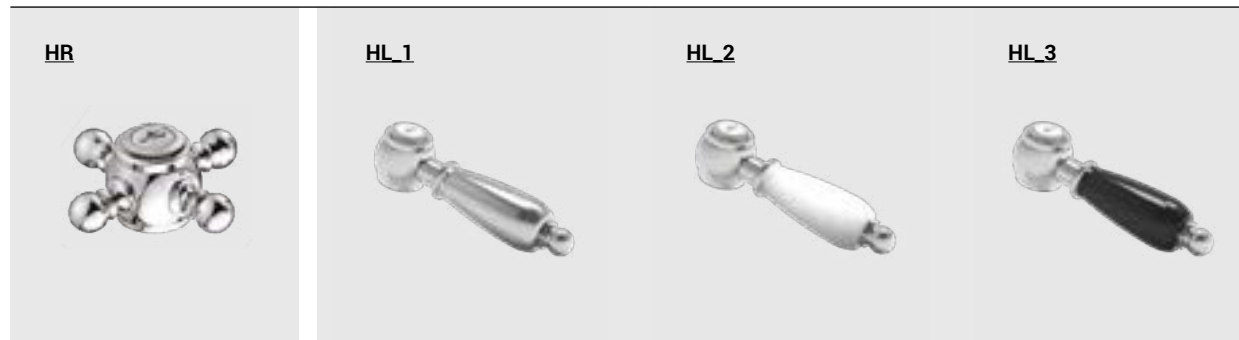

ARTICLE | ARTICOLO | ARTICLE

HR205



Monohole washbasin with two handles complete with drain
Lavabo monoforo con due leve completo di scarico automatico
Mélangeur lavabo monotrou complet avec bonde automatique

CODICE / COEFFICIENTE | CODE / COEFFICIENT

| CODICE / COEFFICIENTE | CODE / COEFFICIENT | COEFFICIENT |
|-----------------------|--------------------|-------------|
| CC | HR205CC | 9,8 |
| PL | HR205PL | 15,7 |
| SS | HR205SS | 12,3 |
| II | HR205II | 14,7 |
| RS | HR205RS | 14,7 |
| OS | HR205OS | 15,7 |
| RR | HR205RR | 13,7 |
| BB | HR205BB | 13,7 |

PACKAGING

L: 370 mm
D: 270 mm
H: 80 mm
3,1 kg

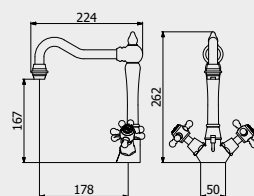

PORTATE | WATER FLOW | DÉBIT D'EAU

| 1 BAR | 2 BAR | 3 BAR |
|--------|--------|--------|
| 10 l/m | 14 l/m | 11 l/m |

ARTICLE | ARTICOLO | ARTICLE

HL205



Monohole washbasin with two handles complete with drain
Lavabo monoforo con due leve completo di scarico automatico
Mélangeur lavabo monotrou complet avec bonde automatique

CODICE / COEFFICIENTE | CODE / COEFFICIENT | CODE / COEFFICIENT

| CODICE / COEFFICIENTE | CODE / COEFFICIENT | CODE / COEFFICIENT | COEFFICIENT | |
|-----------------------|--------------------|--------------------|-------------|------|
| CC | HL205CC_1 | HL205CC_2 | HL205CC_3 | 9,8 |
| PL | HL205PL_1 | HL205PL_2 | HL205PL_3 | 15,7 |
| SS | HL205SS_1 | HL205SS_2 | HL205SS_3 | 12,3 |
| II | HL205II_1 | HL205II_2 | HL205II_3 | 14,7 |
| RS | HL205RS_1 | HL205RS_2 | HL205RS_3 | 14,7 |
| OS | HL205OS_1 | HL205OS_2 | HL205OS_3 | 15,7 |
| RR | HL205RR_1 | HL205RR_2 | HL205RR_3 | 13,7 |
| BB | HL205BB_1 | HL205BB_2 | HL205BB_3 | 13,7 |

PACKAGING

L: 370 mm D: 270 mm H: 80 mm 3,1 kg

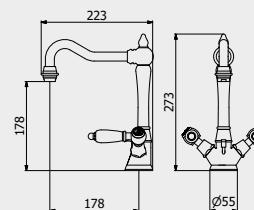

PORTATE | WATER FLOW | DÉBIT D'EAU

| 1 BAR | 2 BAR | 3 BAR |
|--------|--------|--------|
| 10 l/m | 14 l/m | 11 l/m |

ARTICLE | ARTICOLO | ARTICLE

HR306



Wall mounted widespread lavatory faucet
Rubinetto lavabo da incasso
Robinet de lavabo mural

CODICE / COEFFICIENTE | CODE / COEFFICIENT

| CODICE / COEFFICIENTE | CODE / COEFFICIENT | COEFFICIENT |
|-----------------------|--------------------|-------------|
| CC | HR306CC | 11,1 |
| PL | HR306PL | 17,7 |
| SS | HR306SS | 13,8 |
| II | HR306II | 16,6 |
| RS | HR306RS | 16,6 |
| OS | HR306OS | 17,7 |
| RR | HR306RR | 15,5 |
| BB | HR306BB | 15,5 |

PACKAGING

L: 265 mm
D: 260 mm
H: 70 mm
1,8 kg

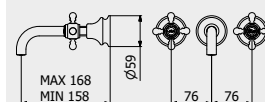

PORTATE | WATER FLOW | DÉBIT D'EAU

| 1 BAR | 2 BAR | 3 BAR |
|-------|--------|--------|
| 9 l/m | 13 l/m | 15 l/m |



ARTICLE | ARTICOLO | ARTICLE

HL306



Wall mounted widespread lavatory faucet
Rubinetto lavabo da incasso
Robinet de lavabo mural

CODICE / COEFFICIENTE | CODE / COEFFICIENT | CODE / COEFFICIENT

| | CC | PL | SS | II | RS | OS | RR | BB |
|-----------|-----------|-----------|-----------|-----------|-----------|-----------|-----------|-----------|
| HL306CC_1 | HL306CC_3 | HL306PL_1 | HL306PL_3 | HL306II_1 | HL306II_3 | HL306OS_1 | HL306RR_1 | HL306BB_1 |
| 11,1 | 11,1 | 17,7 | 17,7 | 16,6 | 16,6 | 17,7 | 15,5 | 15,5 |

PACKAGING

L: 265 mm D: 260 mm H: 70 mm 1,8 kg

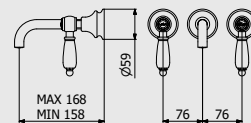

PORTATE | WATER FLOW | DÉBIT D'EAU

| | | |
|-------|--------|--------|
| 1 BAR | 2 BAR | 3 BAR |
| 9 l/m | 13 l/m | 15 l/m |

ARTICLE | ARTICOLO | ARTICLE

HR307



Wall mounted widespread lavatory faucet with long spout
Rubinetto lavabo da incasso con bocca lunga
Robinet de lavabo mural avec bec long

CODICE / COEFFICIENTE | CODE / COEFFICIENT

| | CC | PL | SS | II | RS | OS | RR | BB |
|---------|---------|---------|---------|---------|---------|---------|---------|----|
| HR307CC | HR307PL | HR307SS | HR307II | HR307RS | HR307OS | HR307RR | HR307BB | |
| 11,9 | 19,1 | 14,9 | 17,9 | 17,9 | 19,1 | 16,7 | 16,7 | |

PACKAGING

L: 265 mm
D: 260 mm
H: 70 mm
1,8 kg

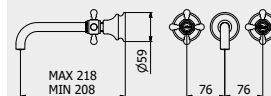

PORTATE | WATER FLOW | DÉBIT D'EAU

| | | |
|-------|--------|--------|
| 1 BAR | 2 BAR | 3 BAR |
| 8 l/m | 11 l/m | 13 l/m |

ARTICLE | ARTICOLO | ARTICLE

HL307



Wall mounted widespread lavatory faucet with long spout
Rubinetto lavabo da incasso con bocca lunga
Robinet de lavabo mural avec bec long

CODICE / COEFFICIENTE | CODE / COEFFICIENT | CODE / COEFFICIENT

| | CC | PL | SS | II | RS | OS | RR | BB |
|-----------|-----------|-----------|-----------|-----------|-----------|-----------|-----------|-----------|
| HL307CC_1 | HL307CC_3 | HL307PL_1 | HL307PL_3 | HL307II_1 | HL307II_3 | HL307OS_1 | HL307RR_1 | HL307BB_1 |
| 11,9 | 11,9 | 19,1 | 19,1 | 17,9 | 17,9 | 19,1 | 16,7 | 16,7 |

PACKAGING

L: 265 mm D: 260 mm H: 70 mm 1,8 kg

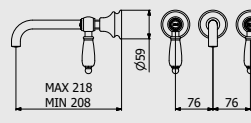

PORTATE | WATER FLOW | DÉBIT D'EAU

| | | |
|-------|--------|--------|
| 1 BAR | 2 BAR | 3 BAR |
| 8 l/m | 11 l/m | 13 l/m |

ARTICLE | ARTICOLO | ARTICLE

HR308



Wall mounted widespread lavatory faucet with short spout
Rubinetto lavabo da incasso con bocca corta
Robinet de lavabo mural avec bec court

CODICE / COEFFICIENTE | CODE / COEFFICIENT

| | CC | PL | SS | II | RS | OS | RR | BB |
|---------|---------|---------|---------|---------|---------|---------|---------|----|
| HR308CC | HR308PL | HR308SS | HR308II | HR308RS | HR308OS | HR308RR | HR308BB | |
| 11,9 | 19,1 | 14,9 | 17,9 | 17,9 | 19,1 | 16,7 | 16,7 | |

PACKAGING

L: 265 mm
D: 260 mm
H: 70 mm
1,8 kg

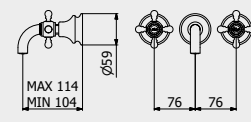

PORTATE | WATER FLOW | DÉBIT D'EAU

| | | |
|-------|--------|--------|
| 1 BAR | 2 BAR | 3 BAR |
| 8 l/m | 11 l/m | 13 l/m |

Hermes

ARTICLE | ARTICOLO | ARTICLE

HL308



Wall mounted widespread lavatory faucet with short spout
Rubinetto lavabo da incasso con bocca corta
Robinet de lavabo mural avec bec court

CODICE / COEFFICIENTE | CODE / COEFFICIENT | CODE / COEFFICIENT

| | CC | PL | SS | II | RS | OS | RR | BB |
|-----------|-----------|-----------|------|----|----|----|----|----|
| HL308CC_1 | HL308CC_3 | HL308CC_3 | 11,9 | | | | | |
| HL308PL_1 | HL308PL_3 | HL308PL_3 | 19,1 | | | | | |
| HL308SS_1 | HL308SS_3 | HL308SS_3 | 14,9 | | | | | |
| HL308II_1 | HL308II_3 | HL308II_3 | 17,9 | | | | | |
| HL308RS_1 | HL308RS_3 | HL308RS_3 | 17,9 | | | | | |
| HL308OS_1 | HL308OS_3 | HL308OS_3 | 19,1 | | | | | |
| HL308RR_1 | HL308RR_3 | HL308RR_3 | 16,7 | | | | | |
| HL308BB_1 | HL308BB_3 | HL308BB_3 | 16,7 | | | | | |

PACKAGING

L: 265 mm D: 260 mm H: 70 mm 1,8 kg

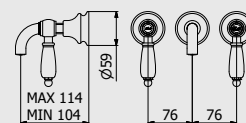

PORTATE | WATER FLOW | DÉBIT D'EAU

| 1 BAR | 2 BAR | 3 BAR |
|-------|--------|--------|
| 8 l/m | 11 l/m | 13 l/m |

ARTICLE | ARTICOLO | ARTICLE

HR390



Three holes washbasin set with tall spout

Lavabo tre fori bocca alta completo di scarico automatico
Lavabo trois trous bec haut

CODICE / COEFFICIENTE | CODE / COEFFICIENT | CODE / COEFFICIENT

| | CC | PL | SS | II | RS | OS | RR | BB |
|---------|------|----|----|----|----|----|----|----|
| HR390CC | 13,3 | | | | | | | |
| HR390PL | 21,3 | | | | | | | |
| HR390SS | 16,6 | | | | | | | |
| HR390II | 20,0 | | | | | | | |
| HR390RS | 20,0 | | | | | | | |
| HR390OS | 21,3 | | | | | | | |
| HR390RR | 18,6 | | | | | | | |
| HR390BB | 18,6 | | | | | | | |

PACKAGING

L: 370 mm
D: 270 mm
H: 80 mm
3,7 kg

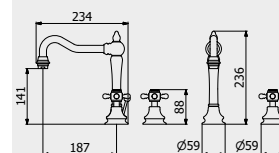

PORTATE | WATER FLOW | DÉBIT D'EAU

| 1 BAR | 2 BAR | 3 BAR |
|---------|--------|--------|
| 9,5 l/m | 14 l/m | 17 l/m |

ARTICLE | ARTICOLO | ARTICLE

HL390



Three holes washbasin set with tall spout

Lavabo tre fori bocca alta completo di scarico automatico
Lavabo trois trous bec haut

CODICE / COEFFICIENTE | CODE / COEFFICIENT | CODE / COEFFICIENT

| | CC | PL | SS | II | RS | OS | RR | BB |
|-----------|-----------|-----------|------|----|----|----|----|----|
| HL390CC_1 | HL390CC_2 | HL390CC_3 | 13,3 | | | | | |
| HL390PL_1 | HL390PL_2 | HL390PL_3 | 21,3 | | | | | |
| HL390SS_1 | HL390SS_2 | HL390SS_3 | 16,6 | | | | | |
| HL390II_1 | HL390II_2 | HL390II_3 | 20,0 | | | | | |
| HL390RS_1 | HL390RS_2 | HL390RS_3 | 20,0 | | | | | |
| HL390OS_1 | HL390OS_2 | HL390OS_3 | 21,3 | | | | | |
| HL390RR_1 | HL390RR_2 | HL390RR_3 | 18,6 | | | | | |
| HL390BB_1 | HL390BB_2 | HL390BB_3 | 18,6 | | | | | |

PACKAGING

L: 370 mm D: 270 mm H: 80 mm 3,7 kg

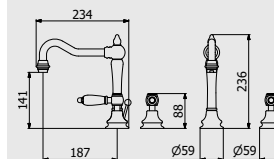

PORTATE | WATER FLOW | DÉBIT D'EAU

| 1 BAR | 2 BAR | 3 BAR |
|---------|--------|--------|
| 9,5 l/m | 14 l/m | 17 l/m |

ARTICLE | ARTICOLO | ARTICLE

HR392



Three holes washbasin set with low spout

Lavabo tre fori a bocca bassa completo di scarico automatico
Lavabo trois trous bec bas

CODICE / COEFFICIENTE | CODE / COEFFICIENT | CODE / COEFFICIENT

| | CC | PL | SS | II | RS | OS | RR | BB |
|---------|------|----|----|----|----|----|----|----|
| HR392CC | 12,4 | | | | | | | |
| HR392PL | 19,8 | | | | | | | |
| HR392SS | 15,5 | | | | | | | |
| HR392II | 18,6 | | | | | | | |
| HR392RS | 18,6 | | | | | | | |
| HR392OS | 19,8 | | | | | | | |
| HR392RR | 17,4 | | | | | | | |
| HR392BB | 17,4 | | | | | | | |

PACKAGING

L: 425 mm
D: 188 mm
H: 98 mm
2,2 kg

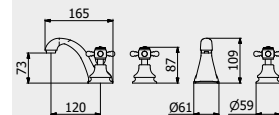

PORTATE | WATER FLOW | DÉBIT D'EAU

| 1 BAR | 2 BAR | 3 BAR |
|---------|--------|--------|
| 9,5 l/m | 14 l/m | 17 l/m |



ARTICLE | ARTICOLO | ARTICLE

HL392



Three holes washbasin set with low spout
Lavabo tre fori a bocca bassa completo di scarico automatico
Lavabo trois trous bec bas

CODICE / COEFFICIENTE | CODE / COEFFICIENT | CODE / COEFFICIENT

| | CC | PL | SS | II | RS | OS | RR | BB |
|--|-----------|-----------|-----------|-----------|-----------|-----------|-----------|-----------|
| | HL392CC_1 | HL392PL_2 | HL392SS_2 | HL392II_2 | HL392RS_2 | HL392OS_2 | HL392RR_2 | HL392BB_2 |
| | HL392CC_3 | HL392PL_3 | HL392SS_3 | HL392II_3 | HL392RS_3 | HL392OS_3 | HL392RR_3 | HL392BB_3 |
| | 12,4 | 19,8 | 15,5 | 18,6 | 18,6 | 19,8 | 17,4 | 17,4 |



PACKAGING

L: 425 mm D: 188 mm H: 98 mm 2,2 kg

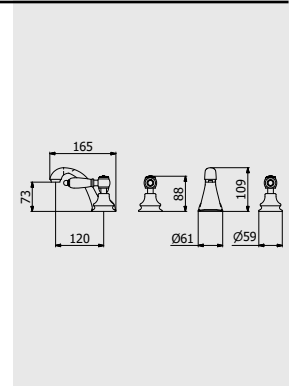

PORTATE | WATER FLOW | DÉBIT D'EAU

| | | |
|---------|--------|--------|
| 1 BAR | 2 BAR | 3 BAR |
| 9,5 l/m | 14 l/m | 17 l/m |

ARTICLE | ARTICOLO | ARTICLE

HR225



Monohole bidet mixer complete with drain
Miscelatore bidet monoforo completo di scarico automatico
Mitigeur bidet complet avec bonde automatique

CODICE / COEFFICIENTE | CODE / COEFFICIENT | CODE / COEFFICIENT

| | CC | PL | SS | II | RS | OS | RR | BB |
|--|---------|---------|---------|---------|---------|---------|---------|---------|
| | HR225CC | HR225PL | HR225SS | HR225II | HR225RS | HR225OS | HR225RR | HR225BB |
| | 9,1 | 14,6 | 11,4 | 13,7 | 13,7 | 14,6 | 12,7 | 12,7 |



PACKAGING

L: 425 mm D: 188 mm H: 98 mm 2,6 kg

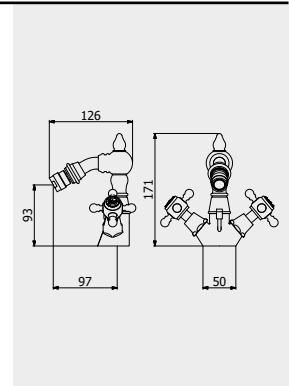

PORTATE | WATER FLOW | DÉBIT D'EAU

| | | |
|--------|--------|--------|
| 1 BAR | 2 BAR | 3 BAR |
| 10 l/m | 14 l/m | 17 l/m |

ARTICLE | ARTICOLO | ARTICLE

HL225



Monohole bidet mixer complete with drain
Miscelatore bidet monoforo completo di scarico automatico
Mitigeur bidet complet avec bonde automatique

CODICE / COEFFICIENTE | CODE / COEFFICIENT | CODE / COEFFICIENT

| | CC | PL | SS | II | RS | OS | RR | BB |
|--|-----------|-----------|-----------|-----------|-----------|-----------|-----------|-----------|
| | HL225CC_1 | HL225PL_2 | HL225SS_2 | HL225II_2 | HL225RS_2 | HL225OS_2 | HL225RR_2 | HL225BB_2 |
| | HL225CC_3 | HL225PL_3 | HL225SS_3 | HL225II_3 | HL225RS_3 | HL225OS_3 | HL225RR_3 | HL225BB_3 |
| | 9,1 | 14,6 | 11,4 | 13,7 | 13,7 | 14,6 | 12,7 | 12,7 |



PACKAGING

L: 425 mm D: 188 mm H: 98 mm 2,6 kg

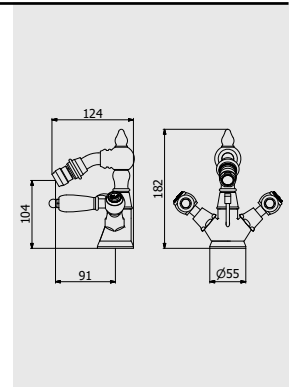

PORTATE | WATER FLOW | DÉBIT D'EAU

| | | |
|--------|--------|--------|
| 1 BAR | 2 BAR | 3 BAR |
| 10 l/m | 14 l/m | 17 l/m |

ARTICLE | ARTICOLO | ARTICLE

HR393



Three holes bidet set
Bidet tre fori con bocca snodabile completo di scarico automatico
Bidet trois trous

CODICE / COEFFICIENTE | CODE / COEFFICIENT | CODE / COEFFICIENT

| | CC | PL | SS | II | RS | OS | RR | BB |
|--|---------|---------|---------|---------|---------|---------|---------|---------|
| | HR393CC | HR393PL | HR393SS | HR393II | HR393RS | HR393OS | HR393RR | HR393BB |
| | 12,7 | 20,3 | 15,9 | 19,1 | 19,1 | 20,3 | 17,8 | 17,8 |



PACKAGING

L: 425 mm D: 188 mm H: 98 mm 3,4 kg

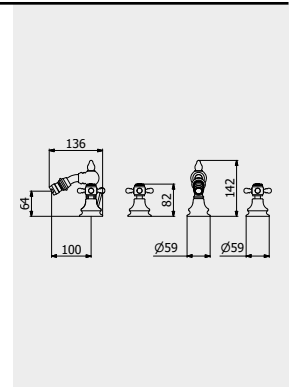

PORTATE | WATER FLOW | DÉBIT D'EAU

| | | |
|---------|--------|--------|
| 1 BAR | 2 BAR | 3 BAR |
| 9,5 l/m | 14 l/m | 17 l/m |

Hermes

ARTICLE | ARTICOLO | ARTICLE

HL393



Three holes bidet set

Bidet tre fori con bocca snodabile completo di scarico automatico

Bidet trois trous

CODICE / COEFFICIENTE | CODE / COEFFICIENT | CODE / COEFFICIENT

| | CC | PL | SS | II | RS | OS | RR | BB |
|-----------|-----------|-----------|------|----|----|----|----|----|
| HL393CC_1 | HL393CC_2 | HL393CC_3 | 12,7 | | | | | |
| HL393PL_1 | HL393PL_2 | HL393PL_3 | 20,3 | | | | | |
| HL393SS_1 | HL393SS_2 | HL393SS_3 | 15,9 | | | | | |
| HL393II_1 | HL393II_2 | HL393II_3 | 19,1 | | | | | |
| HL393RS_1 | HL393RS_2 | HL393RS_3 | 19,1 | | | | | |
| HL393OS_1 | HL393OS_2 | HL393OS_3 | 20,3 | | | | | |
| HL393RR_1 | HL393RR_2 | HL393RR_3 | 17,8 | | | | | |
| HL393BB_1 | HL393BB_2 | HL393BB_3 | 17,8 | | | | | |

PACKAGING

L: 425 mm D: 188 mm H: 98 mm

3,4 kg

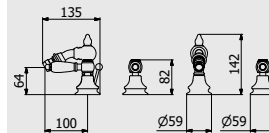

PORTATE | WATER FLOW | DÉBIT D'EAU

| 1 BAR | 2 BAR | 3 BAR |
|---------|--------|--------|
| 9,5 l/m | 14 l/m | 17 l/m |

ARTICLE | ARTICOLO | ARTICLE

HR400



Two holes wall mounted shower

Coppia di rubinetti a parete per doccia una via

Melangeur deux trous douche

CODICE / COEFFICIENTE | CODE / COEFFICIENT | CODE / COEFFICIENT

| | CC | PL | SS | II | RS | OS | RR | BB |
|---------|-----|----|----|----|----|----|----|----|
| HR400CC | 5,6 | | | | | | | |
| HR400PL | 9,0 | | | | | | | |
| HR400SS | 7,0 | | | | | | | |
| HR400II | 8,4 | | | | | | | |
| HR400RS | 8,4 | | | | | | | |
| HR400OS | 9,0 | | | | | | | |
| HR400RR | 7,8 | | | | | | | |
| HR400BB | 7,8 | | | | | | | |

PACKAGING

L: 175 mm
D: 125 mm
H: 90 mm

0,8 kg

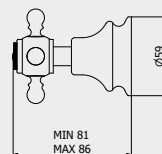

PORTATE | WATER FLOW | DÉBIT D'EAU

| 1 BAR | 2 BAR | 3 BAR |
|--------|--------|--------|
| 26 l/m | 38 l/m | 46 l/m |

ARTICLE | ARTICOLO | ARTICLE

HL400



Two holes wall mounted shower

Coppia di rubinetti a parete per doccia una via

Melangeur deux trous douche

CODICE / COEFFICIENTE | CODE / COEFFICIENT | CODE / COEFFICIENT

| | CC | PL | SS | II | RS | OS | RR | BB |
|-----------|-----------|-----------|-----|----|----|----|----|----|
| HL400CC_1 | HL400CC_2 | HL400CC_3 | 5,6 | | | | | |
| HL400PL_1 | HL400PL_2 | HL400PL_3 | 9,0 | | | | | |
| HL400SS_1 | HL400SS_2 | HL400SS_3 | 7,0 | | | | | |
| HL400II_1 | HL400II_2 | HL400II_3 | 8,4 | | | | | |
| HL400RS_1 | HL400RS_2 | HL400RS_3 | 8,4 | | | | | |
| HL400OS_1 | HL400OS_2 | HL400OS_3 | 9,0 | | | | | |
| HL400RR_1 | HL400RR_2 | HL400RR_3 | 7,8 | | | | | |
| HL400BB_1 | HL400BB_2 | HL400BB_3 | 7,8 | | | | | |

PACKAGING

L: 175 mm D: 125 mm H: 90 mm

0,8 kg

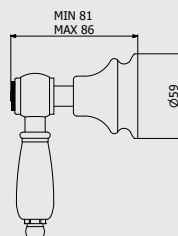

PORTATE | WATER FLOW | DÉBIT D'EAU

| 1 BAR | 2 BAR | 3 BAR |
|--------|--------|--------|
| 26 l/m | 38 l/m | 46 l/m |

ARTICLE | ARTICOLO | ARTICLE

HR410



Three holes wall mounted shower with two ways diverter

Tre rubinetti a parete per doccia con deviatore a due vie

Melangeur trois trous douche avec inverseur deux voies

CODICE / COEFFICIENTE | CODE / COEFFICIENT | CODE / COEFFICIENT

| | CC | PL | SS | II | RS | OS | RR | BB |
|---------|------|----|----|----|----|----|----|----|
| HR410CC | 10,0 | | | | | | | |
| HR410PL | 16,0 | | | | | | | |
| HR410SS | 12,5 | | | | | | | |
| HR410II | 15,0 | | | | | | | |
| HR410RS | 15,0 | | | | | | | |
| HR410OS | 16,0 | | | | | | | |
| HR410RR | 14,0 | | | | | | | |
| HR410BB | 14,0 | | | | | | | |

PACKAGING

L: 340 mm
D: 180 mm
H: 70 mm

2,6 kg

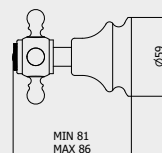

PORTATE | WATER FLOW | DÉBIT D'EAU

| 1 BAR | 2 BAR | 3 BAR |
|--------|--------|--------|
| 12 l/m | 15 l/m | 19 l/m |



ARTICLE | ARTICOLO | ARTICLE

HL410



Three holes wall mounted shower with two ways diverter
Tre rubinetti a parete per doccia con deviatore a due vie
Melangeur trois trous douche avec inverseur deux voies

CODICE / COEFFICIENTE | CODE / COEFFICIENT | CODE / COEFFICIENT

| | CC | PL | SS | II | RS | OS | RR | BB |
|-----------|-----------|-----------|------|----|----|----|----|----|
| HL410CC_1 | HL410CC_2 | HL410CC_3 | 10,0 | | | | | |
| HL410PL_1 | HL410PL_2 | HL410PL_3 | 16,0 | | | | | |
| HL410SS_1 | HL410SS_2 | HL410SS_3 | 12,5 | | | | | |
| HL410II_1 | HL410II_2 | HL410II_3 | 15,0 | | | | | |
| HL410RS_1 | HL410RS_2 | HL410RS_3 | 15,0 | | | | | |
| HL410OS_1 | HL410OS_2 | HL410OS_3 | 16,0 | | | | | |
| HL410RR_1 | HL410RR_2 | HL410RR_3 | 14,0 | | | | | |
| HL410BB_1 | HL410BB_2 | HL410BB_3 | 14,0 | | | | | |

PACKAGING

L: 340 mm D: 180 mm H: 70 mm 2,6 kg

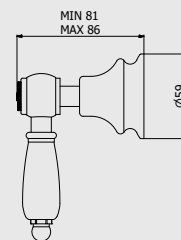

PORTATE | WATER FLOW | DÉBIT D'EAU

| 1 BAR | 2 BAR | 3 BAR |
|--------|--------|--------|
| 12 l/m | 15 l/m | 19 l/m |

ARTICLE | ARTICOLO | ARTICLE

HR199



Shower column with thermostatic valve and showerhead only
Colonna doccia termostatica solo soffione
Colonne de douche thermostatique avec seulement tête de douche

CODICE / COEFFICIENTE | CODE / COEFFICIENT

| | CC | PL | SS | II | RS | OS | RR | BB |
|---------|---------|---------|---------|---------|---------|---------|---------|----|
| HR199CC | HR199PL | HR199SS | HR199II | HR199RS | HR199OS | HR199RR | HR199BB | |
| 53,0 | 84,8 | 66,3 | 79,5 | 79,5 | 84,8 | 74,2 | 74,2 | |

PACKAGING

L: 1003 mm
D: 520 mm
H: 130 mm

14,2 kg

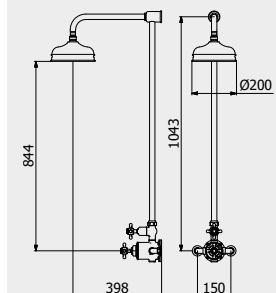

PORTATE | WATER FLOW | DÉBIT D'EAU

| 1 BAR | 2 BAR | 3 BAR |
|--------|--------|--------|
| 23 l/m | 33 l/m | 40 l/m |

ARTICLE | ARTICOLO | ARTICLE

HL199



Shower column with thermostatic valve and showerhead only
Colonna doccia termostatica solo soffione
Colonne de douche thermostatique avec seulement tête de douche

CODICE / COEFFICIENTE | CODE / COEFFICIENT | CODE / COEFFICIENT

| | CC | PL | SS | II | RS | OS | RR | BB |
|-----------|-----------|-----------|------|----|----|----|----|----|
| HL199CC_1 | HL199CC_2 | HL199CC_3 | 53,0 | | | | | |
| HL199PL_1 | HL199PL_2 | HL199PL_3 | 84,8 | | | | | |
| HL199SS_1 | HL199SS_2 | HL199SS_3 | 66,3 | | | | | |
| HL199II_1 | HL199II_2 | HL199II_3 | 79,5 | | | | | |
| HL199RS_1 | HL199RS_2 | HL199RS_3 | 79,5 | | | | | |
| HL199OS_1 | HL199OS_2 | HL199OS_3 | 84,8 | | | | | |
| HL199RR_1 | HL199RR_2 | HL199RR_3 | 74,2 | | | | | |
| HL199BB_1 | HL199BB_2 | HL199BB_3 | 74,2 | | | | | |

PACKAGING

L: 1003 mm D: 520 mm H: 130 mm 14,2 kg

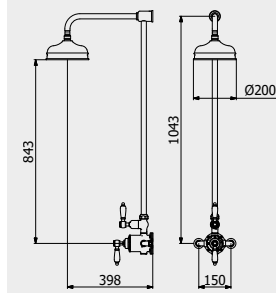

PORTATE | WATER FLOW | DÉBIT D'EAU

| 1 BAR | 2 BAR | 3 BAR |
|--------|--------|--------|
| 23 l/m | 33 l/m | 40 l/m |

Hermes

ARTICLE | ARTICOLO | ARTICLE

HR800



Shower column with mixer and shower kit

Colonna doccia con miscelatore e e kit doccia

Colonne de douche avec mitigeur et kit douche

CODICE / COEFFICIENTE | CODE /
COEFFICIENT | CODE / COEFFICIENT

| | | | |
|---|----|---------|------|
| ● | CC | HR800CC | 27,5 |
| ● | PL | HR800PL | 44,0 |
| ● | SS | HR800SS | 34,4 |
| ● | II | HR800II | 41,3 |
| ● | RS | HR800RS | 41,3 |
| ● | OS | HR800OS | 44,0 |
| ● | RR | HR800RR | 38,5 |
| ● | BB | HR800BB | 38,5 |

PACKAGING

L: 1003 mm
D: 520 mm
H: 130 mm

10 kg

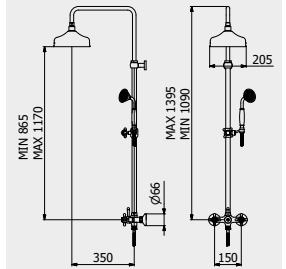

PORTATE | WATER FLOW | DÉBIT D'EAU

| | | |
|-------|--------|----------|
| 1 BAR | 2 BAR | 3 BAR |
| 8 l/m | 12 l/m | 14,5 l/m |

ARTICLE | ARTICOLO | ARTICLE

HL800



Shower column with mixer and shower kit

Colonna doccia con miscelatore e e kit doccia

Colonne de douche avec mitigeur et kit douche

CODICE / COEFFICIENTE | CODE / COEFFICIENT | CODE / COEFFICIENT

| | | | | | |
|---|----|-----------|-----------|-----------|------|
| ● | CC | HL800CC_1 | HL800CC_2 | HL800CC_3 | 27,5 |
| ● | PL | HL800PL_1 | HL800PL_2 | HL800PL_3 | 44,0 |
| ● | SS | HL800SS_1 | HL800SS_2 | HL800SS_3 | 34,4 |
| ● | II | HL800II_1 | HL800II_2 | HL800II_3 | 41,3 |
| ● | RS | HL800RS_1 | HL800RS_2 | HL800RS_3 | 41,3 |
| ● | OS | HL800OS_1 | HL800OS_2 | HL800OS_3 | 44,0 |
| ● | RR | HL800RR_1 | HL800RR_2 | HL800RR_3 | 38,5 |
| ● | BB | HL800BB_1 | HL800BB_2 | HL800BB_3 | 38,5 |

PACKAGING

L: 1003 mm D: 520 mm H: 130 mm

10 kg

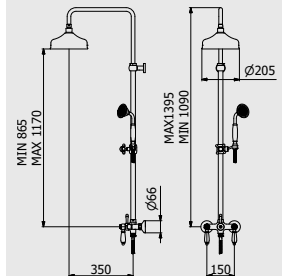

PORTATE | WATER FLOW | DÉBIT D'EAU

| | | |
|-------|--------|----------|
| 1 BAR | 2 BAR | 3 BAR |
| 8 l/m | 12 l/m | 14,5 l/m |

ARTICLE | ARTICOLO | ARTICLE

HR850



Shower column with bath-tub spout

Colonna doccia con bocca d'erogazione per vasca

Colonne de douche avec bec pour baignoire

CODICE / COEFFICIENTE | CODE /
COEFFICIENT | CODE / COEFFICIENT

| | | | |
|---|----|---------|------|
| ● | CC | HR850CC | 21,3 |
| ● | PL | HR850PL | 34,1 |
| ● | SS | HR850SS | 26,6 |
| ● | II | HR850II | 32,0 |
| ● | RS | HR850RS | 32,0 |
| ● | OS | HR850OS | 34,1 |
| ● | RR | HR850RR | 29,8 |
| ● | BB | HR850BB | 29,8 |

PACKAGING

L: 1003 mm
D: 520 mm
H: 130 mm

14,2 kg

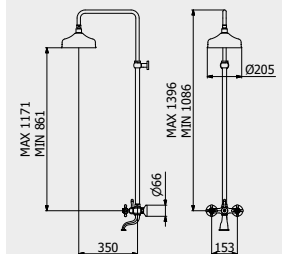

PORTATE | WATER FLOW | DÉBIT D'EAU

| | | |
|-------|--------|----------|
| 1 BAR | 2 BAR | 3 BAR |
| 8 l/m | 12 l/m | 14,5 l/m |



ARTICLE | ARTICOLO | ARTICLE

HL850



Shower column with bath-tub spout

Colonna doccia con bocca d'erogazione per vasca

Colonne de douche avec bec pour baignoire

CODICE / COEFFICIENTE | CODE / COEFFICIENT | CODE / COEFFICIENT

| | CC | PL | SS | II | RS | OS | RR | BB |
|-----------|-----------|-----------|------|----|----|----|----|----|
| HL850CC_1 | HL850CC_2 | HL850CC_3 | 21,3 | | | | | |
| HL850PL_1 | HL850PL_2 | HL850PL_3 | 34,1 | | | | | |
| HL850SS_1 | HL850SS_2 | HL850SS_3 | 26,6 | | | | | |
| HL850II_1 | HL850II_2 | HL850II_3 | 32,0 | | | | | |
| HL850RS_1 | HL850RS_2 | HL850RS_3 | 32,0 | | | | | |
| HL850OS_1 | HL850OS_2 | HL850OS_3 | 34,1 | | | | | |
| HL850RR_1 | HL850RR_2 | HL850RR_3 | 29,8 | | | | | |
| HL850BB_1 | HL850BB_2 | HL850BB_3 | 29,8 | | | | | |

PACKAGING

L: 1003 mm D: 520 mm H: 130 mm 14,2 kg

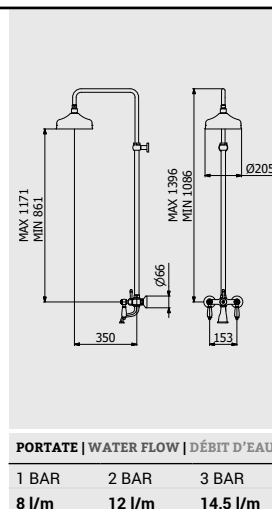

PORTATE | WATER FLOW | DÉBIT D'EAU

| 1 BAR | 2 BAR | 3 BAR |
|-------|--------|----------|
| 8 l/m | 12 l/m | 14,5 l/m |

ARTICLE | ARTICOLO | ARTICLE

HR851



Thermostatic shower column with shower kit

Colonna doccia con miscelatore termostatico e kit doccia

Colonne douche thermostatique et kit douche

CODICE / COEFFICIENTE | CODE / COEFFICIENT | CODE / COEFFICIENT

| | CC | PL | SS | II | RS | OS | RR | BB |
|---------|-------|----|----|----|----|----|----|----|
| HR851CC | 66,8 | | | | | | | |
| HR851PL | 106,9 | | | | | | | |
| HR851SS | 83,5 | | | | | | | |
| HR851II | 100,2 | | | | | | | |
| HR851RS | 100,2 | | | | | | | |
| HR851OS | 106,9 | | | | | | | |
| HR851RR | 93,5 | | | | | | | |
| HR851BB | 93,5 | | | | | | | |

PACKAGING

L: 1003 mm D: 520 mm H: 130 mm

14,2 kg

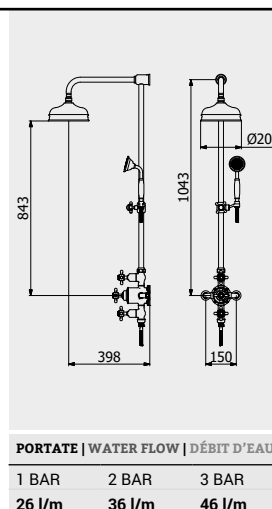

PORTATE | WATER FLOW | DÉBIT D'EAU

| 1 BAR | 2 BAR | 3 BAR |
|--------|--------|--------|
| 26 l/m | 36 l/m | 46 l/m |

ARTICLE | ARTICOLO | ARTICLE

HL851



Thermostatic shower column with shower kit

Colonna doccia con miscelatore termostatico e kit doccia

Colonne douche thermostatique et kit douche

CODICE / COEFFICIENTE | CODE / COEFFICIENT | CODE / COEFFICIENT

| | CC | PL | SS | II | RS | OS | RR | BB |
|-----------|-----------|-----------|-------|----|----|----|----|----|
| HL851CC_1 | HL851CC_2 | HL851CC_3 | 66,8 | | | | | |
| HL851PL_1 | HL851PL_2 | HL851PL_3 | 106,9 | | | | | |
| HL851SS_1 | HL851SS_2 | HL851SS_3 | 83,5 | | | | | |
| HL851II_1 | HL851II_2 | HL851II_3 | 100,2 | | | | | |
| HL851RS_1 | HL851RS_2 | HL851RS_3 | 100,2 | | | | | |
| HL851OS_1 | HL851OS_2 | HL851OS_3 | 106,9 | | | | | |
| HL851RR_1 | HL851RR_2 | HL851RR_3 | 93,5 | | | | | |
| HL851BB_1 | HL851BB_2 | HL851BB_3 | 93,5 | | | | | |

PACKAGING

L: 1003 mm D: 520 mm H: 130 mm 14,2 kg

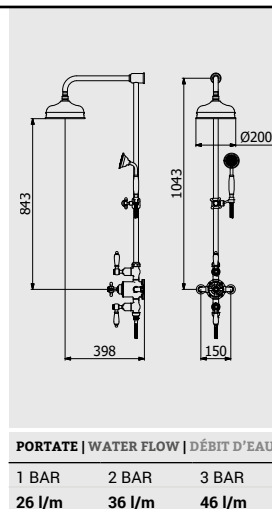

PORTATE | WATER FLOW | DÉBIT D'EAU

| 1 BAR | 2 BAR | 3 BAR |
|--------|--------|--------|
| 26 l/m | 36 l/m | 46 l/m |

Hermes

ARTICLE | ARTICOLO | ARTICLE

HR860



Thermostatic shower column with bath-tub spout

Colonna doccia con miscelatore termostatico e bocca d'erogazione per vasca
Colonne douche thermostatiques et kit douche avec bec de remplissage pour baignoire

CODICE / COEFFICIENTE | CODE / COEFFICIENT

| | | | |
|---|----|---------|-------|
| ● | CC | HR860CC | 64,8 |
| ● | PL | HR860PL | 103,7 |
| ● | SS | HR860SS | 81,0 |
| ● | II | HR860II | 97,2 |
| ● | RS | HR860RS | 97,2 |
| ● | OS | HR860OS | 103,7 |
| ● | RR | HR860RR | 90,7 |
| ● | BB | HR860BB | 90,7 |

PACKAGING

📦 L: 1003 mm
D: 520 mm
H: 130 mm

📏 14,2 kg

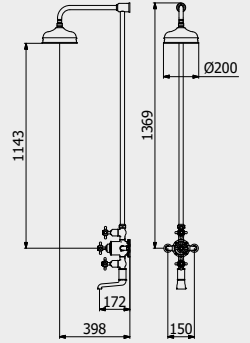

PORTATE | WATER FLOW | DÉBIT D'EAU

| | | |
|--------|--------|--------|
| 1 BAR | 2 BAR | 3 BAR |
| 23 l/m | 33 l/m | 40 l/m |

ARTICLE | ARTICOLO | ARTICLE

HL860



Thermostatic shower column with bath-tub spout

Colonna doccia con miscelatore termostatico e bocca d'erogazione per vasca
Colonne douche thermostatiques et kit douche avec bec de remplissage pour baignoire

CODICE / COEFFICIENTE | CODE / COEFFICIENT | CODE / COEFFICIENT

| | | | | | |
|---|----|-----------|-----------|-----------|-------|
| ● | CC | HL860CC_1 | HL860CC_2 | HL860CC_3 | 64,8 |
| ● | PL | HL860PL_1 | HL860PL_2 | HL860PL_3 | 103,7 |
| ● | SS | HL860SS_1 | HL860SS_2 | HL860SS_3 | 81,0 |
| ● | II | HL860II_1 | HL860II_2 | HL860II_3 | 97,2 |
| ● | RS | HL860RS_1 | HL860RS_2 | HL860RS_3 | 97,2 |
| ● | OS | HL860OS_1 | HL860OS_2 | HL860OS_3 | 103,7 |
| ● | RR | HL860RR_1 | HL860RR_2 | HL860RR_3 | 90,7 |
| ● | BB | HL860BB_1 | HL860BB_2 | HL860BB_3 | 90,7 |

PACKAGING

📦 L: 1003 mm D: 520 mm H: 130 mm

📏 14,2 kg

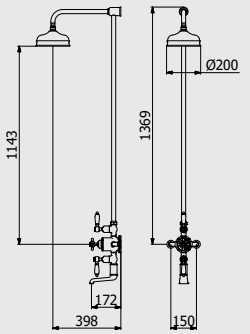

PORTATE | WATER FLOW | DÉBIT D'EAU

| | | |
|--------|--------|--------|
| 1 BAR | 2 BAR | 3 BAR |
| 23 l/m | 33 l/m | 40 l/m |

ARTICLE | ARTICOLO | ARTICLE

HR250



Wall mounted bath filler complete with hand shower kit

Bordo vasca esterno a parete completo di kit doccia
Mitigeur Bain/douche Mural avec douchette encastree

CODICE / COEFFICIENTE | CODE / COEFFICIENT

| | | | |
|---|----|---------|------|
| ● | CC | HR250CC | 15,1 |
| ● | PL | HR250PL | 24,2 |
| ● | SS | HR250SS | 18,9 |
| ● | II | HR250II | 22,7 |
| ● | RS | HR250RS | 22,7 |
| ● | OS | HR250OS | 24,2 |
| ● | RR | HR250RR | 21,1 |
| ● | BB | HR250BB | 21,1 |

PACKAGING

📦 L: 360 mm
D: 220 mm
H: 150 mm

📏 3,6 kg

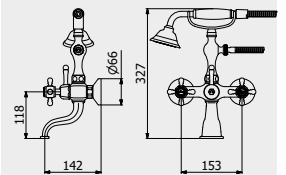

PORTATE | WATER FLOW | DÉBIT D'EAU

| | | |
|--------|--------|--------|
| 1 BAR | 2 BAR | 3 BAR |
| 23 l/m | 32 l/m | 37 l/m |



ARTICLE | ARTICOLO | ARTICLE

HL250



Wall mounted bath filler complete with hand shower kit
Bordo vasca esterno a parete completo di kit doccia
Mitigeur Bain/douche Mural avec douchette encastrée

CODICE / COEFFICIENTE | CODE / COEFFICIENT | CODE / COEFFICIENT

| | CC | PL | SS | II | RS | OS | RR | BB |
|-----------|-----------|-----------|------|----|----|----|----|----|
| HL250CC_1 | HL250CC_2 | HL250CC_3 | 15,1 | | | | | |
| HL250PL_1 | HL250PL_2 | HL250PL_3 | 24,2 | | | | | |
| HL250SS_1 | HL250SS_2 | HL250SS_3 | 18,9 | | | | | |
| HL250II_1 | HL250II_2 | HL250II_3 | 22,7 | | | | | |
| HL250RS_1 | HL250RS_2 | HL250RS_3 | 22,7 | | | | | |
| HL250OS_1 | HL250OS_2 | HL250OS_3 | 24,2 | | | | | |
| HL250RR_1 | HL250RR_2 | HL250RR_3 | 21,1 | | | | | |
| HL250BB_1 | HL250BB_2 | HL250BB_3 | 21,1 | | | | | |

PACKAGING

L: 360 mm D: 220 mm H: 150 mm 3,6 kg

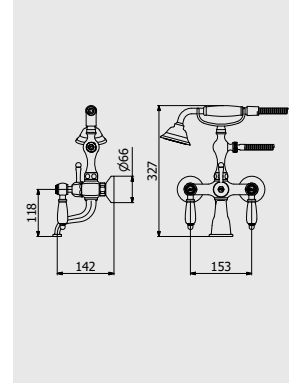

PORTATE | WATER FLOW | DÉBIT D'EAU

| 1 BAR | 2 BAR | 3 BAR |
|--------|--------|--------|
| 23 l/m | 32 l/m | 37 l/m |

ARTICLE | ARTICOLO | ARTICLE

HR350



Wall mounted shower mixer with shower kit
Doccia esterno a parete completo di kit doccia
Mitigeur de douche externe avec flexible et douchette

CODICE / COEFFICIENTE | CODE / COEFFICIENT

| | CC | PL | SS | II | RS | OS | RR | BB |
|---------|---------|---------|---------|---------|---------|---------|---------|----|
| HR350CC | HR350PL | HR350SS | HR350II | HR350RS | HR350OS | HR350RR | HR350BB | |
| 7,4 | 11,8 | 9,3 | 11,1 | 11,1 | 11,8 | 10,4 | 10,4 | |

PACKAGING

L: 425 mm
D: 188 mm
H: 98 mm
1,7 kg

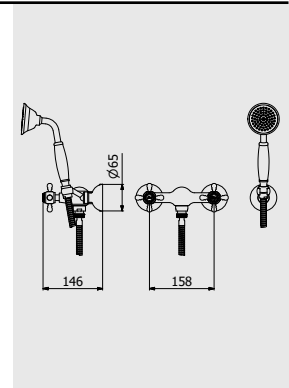

PORTATE | WATER FLOW | DÉBIT D'EAU

| 1 BAR | 2 BAR | 3 BAR |
|----------|----------|--------|
| 14,9 l/m | 21,5 l/m | 26 l/m |

ARTICLE | ARTICOLO | ARTICLE

HL350



Wall mounted shower mixer with shower kit
Doccia esterno a parete completo di kit doccia
Mitigeur de douche externe avec flexible et douchette

CODICE / COEFFICIENTE | CODE / COEFFICIENT | CODE / COEFFICIENT

| | CC | PL | SS | II | RS | OS | RR | BB |
|-----------|-----------|-----------|------|----|----|----|----|----|
| HL350CC_1 | HL350CC_2 | HL350CC_3 | 7,4 | | | | | |
| HL350PL_1 | HL350PL_2 | HL350PL_3 | 11,8 | | | | | |
| HL350SS_1 | HL350SS_2 | HL350SS_3 | 9,3 | | | | | |
| HL350II_1 | HL350II_2 | HL350II_3 | 11,1 | | | | | |
| HL350RS_1 | HL350RS_2 | HL350RS_3 | 11,1 | | | | | |
| HL350OS_1 | HL350OS_2 | HL350OS_3 | 11,8 | | | | | |
| HL350RR_1 | HL350RR_2 | HL350RR_3 | 10,4 | | | | | |
| HL350BB_1 | HL350BB_2 | HL350BB_3 | 10,4 | | | | | |

PACKAGING

L: 425 mm D: 188 mm H: 98 mm 1,7 kg

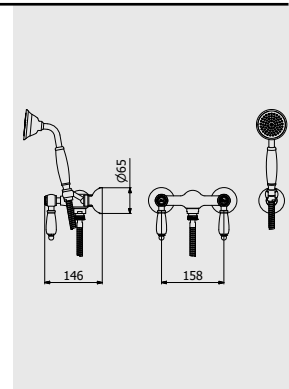

PORTATE | WATER FLOW | DÉBIT D'EAU

| 1 BAR | 2 BAR | 3 BAR |
|----------|----------|--------|
| 14,9 l/m | 21,5 l/m | 26 l/m |

Hermes

ARTICLE | ARTICOLO | ARTICLE

HR396



Five holes deck mounted bath filler with shower kit
Bordo vasca cinque fori con deviatore e kit doccia
Bain/douche cinq trous avec inverseur et Kit Douche

CODICE / COEFFICIENTE | CODE / COEFFICIENT

| | CC | PL | SS | II | RS | OS | RR | BB |
|---------|---------|---------|---------|---------|---------|---------|---------|----|
| HR396CC | HR396PL | HR396SS | HR396II | HR396RS | HR396OS | HR396RR | HR396BB | |
| 22,2 | 35,5 | 27,8 | 33,3 | 33,3 | 35,5 | 31,1 | 31,1 | |

PACKAGING

L: 455 mm
D: 310 mm
H: 75 mm
6,1 kg

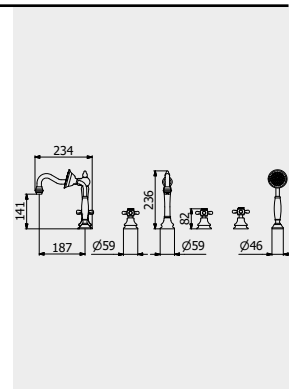

PORTATE | WATER FLOW | DÉBIT D'EAU

| 1 BAR | 2 BAR | 3 BAR |
|---------|--------|--------|
| 9,5 l/m | 14 l/m | 17 l/m |

ARTICLE | ARTICOLO | ARTICLE

HL396



Five holes deck mounted bath filler with shower kit

Bordo vasca cinque fori con deviatore e kit doccia

Bain/douche cinq trous avec inverseur et Kit Douche

CODICE / COEFFICIENTE | CODE / COEFFICIENT | CODE / COEFFICIENT

| | CC | PL | SS | II | RS | OS | RR | BB |
|-----------|-----------|-----------|------|----|----|----|----|----|
| HL396CC_1 | HL396CC_2 | HL396CC_3 | 22,2 | | | | | |
| HL396PL_1 | HL396PL_2 | HL396PL_3 | 35,5 | | | | | |
| HL396SS_1 | HL396SS_2 | HL396SS_3 | 27,8 | | | | | |
| HL396II_1 | HL396II_2 | HL396II_3 | 33,3 | | | | | |
| HL396RS_1 | HL396RS_2 | HL396RS_3 | 33,3 | | | | | |
| HL396OS_1 | HL396OS_2 | HL396OS_3 | 35,5 | | | | | |
| HL396RR_1 | HL396RR_2 | HL396RR_3 | 31,1 | | | | | |
| HL396BB_1 | HL396BB_2 | HL396BB_3 | 31,1 | | | | | |

PACKAGING

L: 455 mm D: 310 mm H: 75 mm 6,1 kg

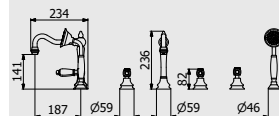

PORTATE | WATER FLOW | DÉBIT D'EAU

1 BAR 2 BAR 3 BAR
9,5 l/m 14 l/m 17 l/m

ARTICLE | ARTICOLO | ARTICLE

HR397



4 holes bath filler with overflow outlet connection, diverter and shower kit

Bordo vasca 4 fori per colonna riempimento con deviatore e kit doccia

Bain/douche 4 trous avec inverseur et Kit Douche pour remplissage ETP

CODICE / COEFFICIENTE | CODE / COEFFICIENT | CODE / COEFFICIENT

| | CC | PL | SS | II | RS | OS | RR | BB |
|---------|---------|---------|---------|---------|---------|---------|---------|----|
| HR397CC | HR397PL | HR397SS | HR397II | HR397RS | HR397OS | HR397RR | HR397BB | |
| 15,4 | 24,6 | 19,3 | 23,1 | 23,1 | 24,6 | 21,6 | 21,6 | |

PACKAGING

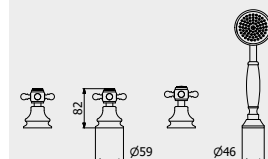
L: 360 mm
D: 220 mm
H: 150 mm
5 kg

PORTATE | WATER FLOW | DÉBIT D'EAU

1 BAR 2 BAR 3 BAR
19,7 l/m 27,5 l/m 33,1 l/m

ARTICLE | ARTICOLO | ARTICLE

HL397



4 holes bath filler with overflow outlet connection, diverter and shower kit

Bordo vasca 4 fori per colonna riempimento con deviatore e kit doccia

Bain/douche 4 trous avec inverseur et Kit Douche pour remplissage ETP

CODICE / COEFFICIENTE | CODE / COEFFICIENT | CODE / COEFFICIENT

| | CC | PL | SS | II | RS | OS | RR | BB |
|-----------|-----------|-----------|-----------|-----------|-----------|-----------|-----------|-----------|
| HL397CC_1 | HL397CC_2 | HL397CC_3 | HL397PL_1 | HL397PL_2 | HL397PL_3 | HL397SS_1 | HL397SS_2 | HL397SS_3 |
| HL397II_1 | HL397II_2 | HL397II_3 | HL397RS_1 | HL397RS_2 | HL397RS_3 | HL397OS_1 | HL397OS_2 | HL397OS_3 |
| HL397RR_1 | HL397RR_2 | HL397RR_3 | HL397BB_1 | HL397BB_2 | HL397BB_3 | 23,1 | 23,1 | 23,1 |
| | | | | | | 24,6 | 21,6 | 21,6 |

PACKAGING

L: 360 mm D: 220 mm H: 150 mm 5 kg

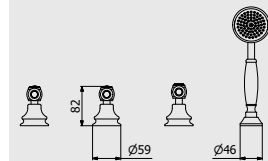

PORTATE | WATER FLOW | DÉBIT D'EAU

1 BAR 2 BAR 3 BAR
19,7 l/m 27,5 l/m 33,1 l/m

ARTICLE | ARTICOLO | ARTICLE

HR398



Five holes wall-mounted bath filler with shower kit

Bordo vasca a parete cinque fori con deviatore e kit doccia

Bain/douche mural cinq trous avec inverseur et Kit Douche

CODICE / COEFFICIENTE | CODE / COEFFICIENT | CODE / COEFFICIENT

| | CC | PL | SS | II | RS | OS | RR | BB |
|---------|---------|---------|---------|---------|---------|---------|---------|----|
| HR398CC | HR398PL | HR398SS | HR398II | HR398RS | HR398OS | HR398RR | HR398BB | |
| 16,3 | 26,1 | 20,4 | 24,5 | 24,5 | 26,1 | 22,8 | 22,8 | |

PACKAGING

L: 370 mm
D: 270 mm
H: 80 mm
3,6 kg

PORTATE | WATER FLOW | DÉBIT D'EAU

1 BAR 2 BAR 3 BAR
9 l/m 13 l/m 15 l/m

ARTICLE | ARTICOLO | ARTICLE

HL398



Five holes wall-mounted bath filler with shower kit
Bordo vasca a parete cinque fori con deviatore e kit doccia
Bain/douche mural cinq trous avec inverseur et Kit Douche

CODICE / COEFFICIENTE | CODE / COEFFICIENT | CODE / COEFFICIENT

| | CC | PL | SS | II | RS | OS | RR | BB |
|-----------|-----------|-----------|------|----|----|----|----|----|
| HL398CC_1 | HL398CC_2 | HL398CC_3 | 16,3 | | | | | |
| HL398PL_1 | HL398PL_2 | HL398PL_3 | 26,1 | | | | | |
| HL398SS_1 | HL398SS_2 | HL398SS_3 | 20,4 | | | | | |
| HL398II_1 | HL398II_2 | HL398II_3 | 24,5 | | | | | |
| HL398RS_1 | HL398RS_2 | HL398RS_3 | 24,5 | | | | | |
| HL398OS_1 | HL398OS_2 | HL398OS_3 | 26,1 | | | | | |
| HL398RR_1 | HL398RR_2 | HL398RR_3 | 22,8 | | | | | |
| HL398BB_1 | HL398BB_2 | HL398BB_3 | 22,8 | | | | | |

PACKAGING

L: 370 mm D: 270 mm H: 80 mm 3,6 kg

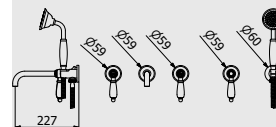

PORTATE | WATER FLOW | DÉBIT D'EAU

| 1 BAR | 2 BAR | 3 BAR |
|----------|----------|----------|
| 19,7 l/m | 27,5 l/m | 33,1 l/m |

ARTICLE | ARTICOLO | ARTICLE

HR320



Wall mounted spout
Bocca d'erogazione a parete
Bec de remplissage mural

CODICE / COEFFICIENTE | CODE / COEFFICIENT

| | CC | PL | SS | II | RS | OS | RR | BB |
|---------|---------|---------|---------|---------|---------|---------|---------|----|
| HR320CC | HR320PL | HR320SS | HR320II | HR320RS | HR320OS | HR320RR | HR320BB | |
| 2,1 | 3,4 | 2,6 | 3,2 | 3,2 | 3,4 | 2,9 | 2,9 | |

PACKAGING

L: 175 mm
D: 125 mm
H: 90 mm

0,3 kg

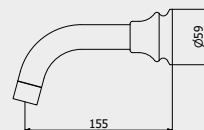

PORTATE | WATER FLOW | DÉBIT D'EAU

| 1 BAR | 2 BAR | 3 BAR |
|---------|----------|----------|
| 9,9 l/m | 13,8 l/m | 16,8 l/m |

ARTICLE | ARTICOLO | ARTICLE

HR321



Short wall mounted spout
Bocca d'erogazione corta a parete
Bec de remplissage mural court

CODICE / COEFFICIENTE | CODE / COEFFICIENT

| | CC | PL | SS | II | RS | OS | RR | BB |
|---------|---------|---------|---------|---------|---------|---------|---------|----|
| HR321CC | HR321PL | HR321SS | HR321II | HR321RS | HR321OS | HR321RR | HR321BB | |
| 2,5 | 4,0 | 3,1 | 3,8 | 3,8 | 4,0 | 3,5 | 3,5 | |

PACKAGING

L: 175 mm
D: 125 mm
H: 90 mm

0,3 kg

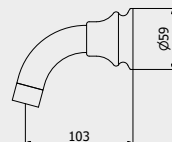

PORTATE | WATER FLOW | DÉBIT D'EAU

| 1 BAR | 2 BAR | 3 BAR |
|---------|----------|----------|
| 9,9 l/m | 13,8 l/m | 16,8 l/m |

ARTICLE | ARTICOLO | ARTICLE

HR322



Long wall mounted spout
Bocca d'erogazione lunga a parete
Bec de remplissage mural long

CODICE / COEFFICIENTE | CODE / COEFFICIENT

| | CC | PL | SS | II | RS | OS | RR | BB |
|---------|---------|---------|---------|---------|---------|---------|---------|----|
| HR322CC | HR322PL | HR322SS | HR322II | HR322RS | HR322OS | HR322RR | HR322BB | |
| 2,5 | 4,0 | 3,1 | 3,8 | 3,8 | 4,0 | 3,5 | 3,5 | |

PACKAGING

L: 175 mm
D: 125 mm
H: 90 mm

0,3 kg

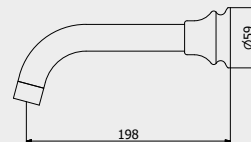

PORTATE | WATER FLOW | DÉBIT D'EAU

| 1 BAR | 2 BAR | 3 BAR |
|---------|----------|----------|
| 9,9 l/m | 13,8 l/m | 16,8 l/m |

Hermes

ARTICOLO | ARTICLE | ARTICLE

HR046



Duplex

Duplex

Duplex

CODICE / COEFFICIENTE | CODE / COEFFICIENT

| | | | |
|---|----|---------|-----|
| ● | CC | HR046CC | 4,0 |
| ● | PL | HR046PL | 6,4 |
| ● | SS | HR046SS | 5,0 |
| ● | II | HR046II | 6,0 |
| ● | RS | HR046RS | 6,0 |
| ● | OS | HR046OS | 6,4 |
| ● | RR | HR046RR | 5,6 |
| ● | BB | HR046BB | 5,6 |

PACKAGING

L: 280 mm
D: 130 mm
H: 70 mm

1,2 kg

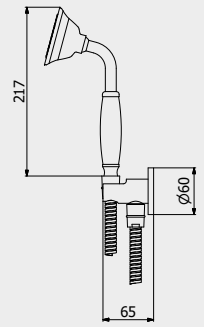

PORTATE | WATER FLOW | DÉBIT D'EAU

| | | |
|----------|----------|--------|
| 1 BAR | 2 BAR | 3 BAR |
| 15,5 l/m | 23,2 l/m | 30 l/m |

ARTICLE | ARTICOLO | ARTICLE

HR371



Dual Control Kitchen Mixer

Lavello monoforo con due leve

Évier de cuisine

CODICE / COEFFICIENTE | CODE / COEFFICIENT

| | | | |
|---|----|---------|------|
| ● | CC | HR371CC | 9,2 |
| ● | PL | HR371PL | 14,7 |
| ● | SS | HR371SS | 11,5 |
| ● | II | HR371II | 13,8 |
| ● | RS | HR371RS | 13,8 |
| ● | OS | HR371OS | 14,7 |
| ● | RR | HR371RR | 12,9 |
| ● | BB | HR371BB | 12,9 |

PACKAGING

L: 370 mm
D: 270 mm
H: 80 mm

2,6 kg

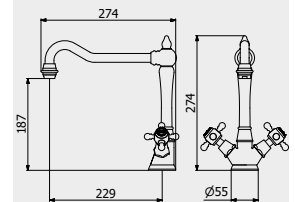

PORTATE | WATER FLOW | DÉBIT D'EAU

| | | |
|---------|--------|--------|
| 1 BAR | 2 BAR | 3 BAR |
| 9,5 l/m | 11 l/m | 15 l/m |

ARTICLE | ARTICOLO | ARTICLE

HL371



Dual Control Kitchen Mixer

Lavello monoforo con due leve

Évier de cuisine

CODICE / COEFFICIENTE | CODE / COEFFICIENT | CODE / COEFFICIENT

| | | | | | |
|---|----|-----------|-----------|-----------|------|
| ● | CC | HL371CC_1 | HL371CC_2 | HL371CC_3 | 9,2 |
| ● | PL | HL371PL_1 | HL371PL_2 | HL371PL_3 | 14,7 |
| ● | SS | HL371SS_1 | HL371SS_2 | HL371SS_3 | 11,5 |
| ● | II | HL371II_1 | HL371II_2 | HL371II_3 | 13,8 |
| ● | RS | HL371RS_1 | HL371RS_2 | HL371RS_3 | 13,8 |
| ● | OS | HL371OS_1 | HL371OS_2 | HL371OS_3 | 14,7 |
| ● | RR | HL371RR_1 | HL371RR_2 | HL371RR_3 | 12,9 |
| ● | BB | HL371BB_1 | HL371BB_2 | HL371BB_3 | 12,9 |

PACKAGING

L: 370 mm D: 270 mm H: 80 mm

2,6 kg

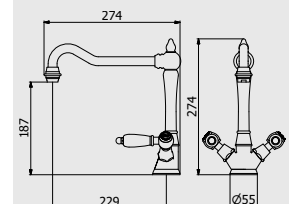

PORTATE | WATER FLOW | DÉBIT D'EAU

| | | |
|---------|--------|--------|
| 1 BAR | 2 BAR | 3 BAR |
| 9,5 l/m | 11 l/m | 15 l/m |



ARTICLE | ARTICOLO | ARTICLE

HR373



Dual control Wall mounted kitchen mixer

Lavello a parete con due leve

Évier de cuisine encastré au mur

CODICE / COEFFICIENTE | CODE / COEFFICIENT

| | | |
|----|---------|------|
| CC | HR373CC | 7,4 |
| PL | HR373PL | 11,8 |
| SS | HR373SS | 9,3 |
| II | HR373II | 11,1 |
| RS | HR373RS | 11,1 |
| OS | HR373OS | 11,8 |
| RR | HR373RR | 10,4 |
| BB | HR373BB | 10,4 |

PACKAGING

L: 425 mm
D: 188 mm
H: 98 mm

1,8 kg

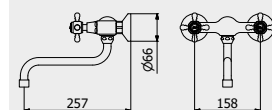

PORTATE | WATER FLOW | DÉBIT D'EAU

| | | |
|--------|--------|--------|
| 1 BAR | 2 BAR | 3 BAR |
| 10 l/m | 15 l/m | 18 l/m |

ARTICLE | ARTICOLO | ARTICLE

HL373



Dual control Wall mounted kitchen mixer

Lavello a parete con due leve

Évier de cuisine encastré au mur

CODICE / COEFFICIENTE | CODE / COEFFICIENT | CODE / COEFFICIENT

| CC | HL373CC_1 | HL373CC_2 | HL373CC_3 7,4 |
|----|-----------|-----------|----------------|
| PL | HL373PL_1 | HL373PL_2 | HL373PL_3 11,8 |
| SS | HL373SS_1 | HL373SS_2 | HL373SS_3 9,3 |
| II | HL373II_1 | HL373II_2 | HL373II_3 11,1 |
| RS | HL373RS_1 | HL373RS_2 | HL373RS_3 11,1 |
| OS | HL373OS_1 | HL373OS_2 | HL373OS_3 11,8 |
| RR | HL373RR_1 | HL373RR_2 | HL373RR_3 10,4 |
| BB | HL373BB_1 | HL373BB_2 | HL373BB_3 10,4 |

PACKAGING

L: 425 mm D: 188 mm H: 98 mm

1,8 kg

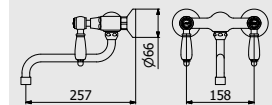

PORTATE | WATER FLOW | DÉBIT D'EAU

| | | |
|--------|--------|--------|
| 1 BAR | 2 BAR | 3 BAR |
| 10 l/m | 15 l/m | 18 l/m |

HERMES / ACCESSORIES COLLECTION

ARTICLE | ARTICOLO | ARTICLE

HR001

Wall soap-holder

Porta sapone a muro

Porte distributeur de savon encastré



| CODICE / COEFFICIENTE | CODE / COEFFICIENT | CODE / COEFFICIENT |
|-----------------------|--------------------|--------------------|
| CC | HR001CC | 2,7 |
| PL | HR001PL | 4,3 |
| SS | HR001SS | 3,4 |
| II | HR001II | 4,1 |
| RS | HR001RS | 4,1 |
| OS | HR001OS | 4,3 |
| RR | HR001RR | 3,8 |
| BB | HR001BB | 3,8 |

| | | |
|----|---------|-----|
| CC | HR001CC | 2,7 |
| PL | HR001PL | 4,3 |
| SS | HR001SS | 3,4 |
| II | HR001II | 4,1 |
| RS | HR001RS | 4,1 |
| OS | HR001OS | 4,3 |
| RR | HR001RR | 3,8 |
| BB | HR001BB | 3,8 |

PACKAGING

L: 160 mm
 D: 125 mm
 H: 60 mm
 0,4 kg

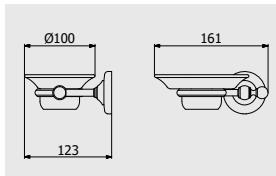

ARTICLE | ARTICOLO | ARTICLE

HR003

Wall toothbrush holder

Bicchiere porta spazzolino a parete

Porte-verre en verre gravé



| CODICE / COEFFICIENTE | CODE / COEFFICIENT | CODE / COEFFICIENT |
|-----------------------|--------------------|--------------------|
| CC | HR003CC | 2,6 |
| PL | HR003PL | 4,2 |
| SS | HR003SS | 3,3 |
| II | HR003II | 3,9 |
| RS | HR003RS | 3,9 |
| OS | HR003OS | 4,2 |
| RR | HR003RR | 3,6 |
| BB | HR003BB | 3,6 |

| | | |
|----|---------|-----|
| CC | HR003CC | 2,6 |
| PL | HR003PL | 4,2 |
| SS | HR003SS | 3,3 |
| II | HR003II | 3,9 |
| RS | HR003RS | 3,9 |
| OS | HR003OS | 4,2 |
| RR | HR003RR | 3,6 |
| BB | HR003BB | 3,6 |

PACKAGING

L: 135 mm
 D: 115 mm
 H: 105 mm
 0,4 kg

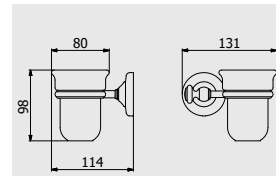

ARTICLE | ARTICOLO | ARTICLE

HR004

Towel holder

Porta salvietta

Porte-serviette



| CODICE / COEFFICIENTE | CODE / COEFFICIENT | CODE / COEFFICIENT |
|-----------------------|--------------------|--------------------|
| CC | HR004CC | 3,9 |
| PL | HR004PL | 6,2 |
| SS | HR004SS | 4,9 |
| II | HR004II | 5,9 |
| RS | HR004RS | 5,9 |
| OS | HR004OS | 6,2 |
| RR | HR004RR | 5,5 |
| BB | HR004BB | 5,5 |

| | | |
|----|---------|-----|
| CC | HR004CC | 3,9 |
| PL | HR004PL | 6,2 |
| SS | HR004SS | 4,9 |
| II | HR004II | 5,9 |
| RS | HR004RS | 5,9 |
| OS | HR004OS | 6,2 |
| RR | HR004RR | 5,5 |
| BB | HR004BB | 5,5 |

PACKAGING

L: 605 mm
 D: 85 mm
 H: 60 mm
 0,6 kg

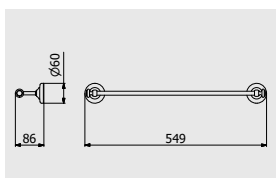

ARTICLE | ARTICOLO | ARTICLE

HR005

Swiveable towel holder

Porta salvietta doppio

Porte-serviettes noeud



| CODICE / COEFFICIENTE | CODE / COEFFICIENT | CODE / COEFFICIENT |
|-----------------------|--------------------|--------------------|
| CC | HR005CC | 4,9 |
| PL | HR005PL | 7,8 |
| SS | HR005SS | 6,1 |
| II | HR005II | 7,4 |
| RS | HR005RS | 7,4 |
| OS | HR005OS | 7,8 |
| RR | HR005RR | 6,9 |
| BB | HR005BB | 6,9 |

| | | |
|----|---------|-----|
| CC | HR005CC | 4,9 |
| PL | HR005PL | 7,8 |
| SS | HR005SS | 6,1 |
| II | HR005II | 7,4 |
| RS | HR005RS | 7,4 |
| OS | HR005OS | 7,8 |
| RR | HR005RR | 6,9 |
| BB | HR005BB | 6,9 |

PACKAGING

L: 440 mm
 D: 60 mm
 H: 60 mm
 0,5 kg

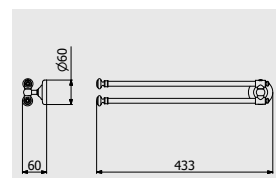

ARTICLE | ARTICOLO | ARTICLE

HR014

Towel holder
Porta salvietta
Porte-serviette

| CODICE / COEFFICIENTE | CODE / COEFFICIENT | |
|-----------------------|--------------------|-----|
| CC | HR014CC | 3,5 |
| PL | HR014PL | 5,6 |
| SS | HR014SS | 4,4 |
| II | HR014II | 5,3 |
| RS | HR014RS | 5,3 |
| OS | HR014OS | 5,6 |
| RR | HR014RR | 4,9 |
| BB | HR014BB | 4,9 |

PACKAGING

L: 135 mm
D: 115 mm
H: 105 mm

0,4 kg

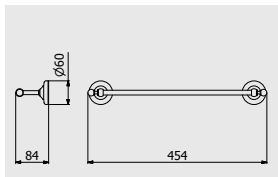

ARTICLE | ARTICOLO | ARTICLE

HR006

Towel holder
Porta salvietta
Porte-serviette

| CODICE / COEFFICIENTE | CODE / COEFFICIENT | |
|-----------------------|--------------------|-----|
| CC | HR006CC | 3,5 |
| PL | HR006PL | 5,6 |
| SS | HR006SS | 4,4 |
| II | HR006II | 5,3 |
| RS | HR006RS | 5,3 |
| OS | HR006OS | 5,6 |
| RR | HR006RR | 4,9 |
| BB | HR006BB | 4,9 |

PACKAGING

L: 310 mm
D: 85 mm
H: 60 mm

0,4 kg

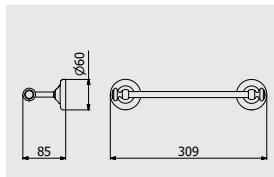

ARTICLE | ARTICOLO | ARTICLE

HR007

Ring Towel holder
Porta salvietta ad anello
Porte-serviette anneau

| CODICE / COEFFICIENTE | CODE / COEFFICIENT | |
|-----------------------|--------------------|-----|
| CC | HR007CC | 2,5 |
| PL | HR007PL | 4,0 |
| SS | HR007SS | 3,1 |
| II | HR007II | 3,8 |
| RS | HR007RS | 3,8 |
| OS | HR007OS | 4,0 |
| RR | HR007RR | 3,5 |
| BB | HR007BB | 3,5 |

PACKAGING

L: 195 mm
D: 60 mm
H: 215 mm

0,3 kg

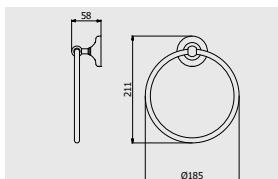

ARTICLE | ARTICOLO | ARTICLE

HR008

Robe Hook
Appendino a parete
Cintre

| CODICE / COEFFICIENTE | CODE / COEFFICIENT | |
|-----------------------|--------------------|-----|
| CC | HR008CC | 1,4 |
| PL | HR008PL | 2,2 |
| SS | HR008SS | 1,8 |
| II | HR008II | 2,1 |
| RS | HR008RS | 2,1 |
| OS | HR008OS | 2,2 |
| RR | HR008RR | 2,0 |
| BB | HR008BB | 2,0 |

PACKAGING

L: 60 mm
D: 65 mm
H: 70 mm

0,2 kg

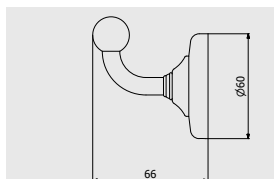

ARTICLE | ARTICOLO | ARTICLE

HR009

Double robe hook
Doppio appendino a paret
Double cintre

| CODICE / COEFFICIENTE | CODE / COEFFICIENT | |
|-----------------------|--------------------|-----|
| CC | HR009CC | 1,7 |
| PL | HR009PL | 2,7 |
| SS | HR009SS | 2,1 |
| II | HR009II | 2,6 |
| RS | HR009RS | 2,6 |
| OS | HR009OS | 2,7 |
| RR | HR009RR | 2,4 |
| BB | HR009BB | 2,4 |

PACKAGING

L: 80 mm
D: 60 mm
H: 80 mm

0,4 kg

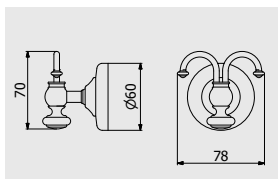

ARTICLE | ARTICOLO | ARTICLE

HR010

Shelf
Mensola
Etager

| CODICE / COEFFICIENTE | CODE / COEFFICIENT | |
|-----------------------|--------------------|-----|
| CC | HR010CC | 4,5 |
| PL | HR010PL | 7,2 |
| SS | HR010SS | 5,6 |
| II | HR010II | 6,8 |
| RS | HR010RS | 6,8 |
| OS | HR010OS | 7,2 |
| RR | HR010RR | 6,3 |
| BB | HR010BB | 6,3 |

PACKAGING

L: 600 mm
D: 135 mm
H: 65 mm

0,5 kg

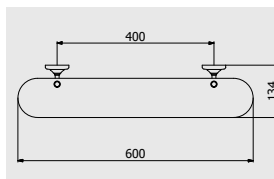

Hermes

ARTICLE | ARTICOLO | ARTICLE

HR012

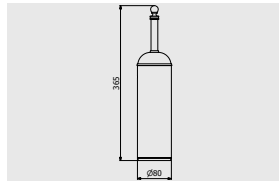

Toilet brush holder

Porta scopino da terra

Porte balayette au sol

| CODICE / COEFFICIENTE | CODE / COEFFICIENT | |
|-----------------------|--------------------|-----|
| CC | HR012CC | 4,5 |
| PL | HR012PL | 7,2 |
| SS | HR012SS | 5,6 |
| II | HR012II | 6,8 |
| RS | HR012RS | 6,8 |
| OS | HR012OS | 7,2 |
| RR | HR012RR | 6,3 |
| BB | HR012BB | 6,3 |

PACKAGING

L: 80 mm
D: 80 mm
H: 365 mm

0,8 kg

ARTICLE | ARTICOLO | ARTICLE

HR013

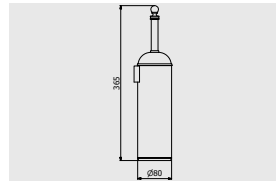

Wall toilet brush holder

Porta scopino da parete

Porte balayette

| CODICE / COEFFICIENTE | CODE / COEFFICIENT | |
|-----------------------|--------------------|-----|
| CC | HR013CC | 4,8 |
| PL | HR013PL | 7,7 |
| SS | HR013SS | 6,0 |
| II | HR013II | 7,2 |
| RS | HR013RS | 7,2 |
| OS | HR013OS | 7,7 |
| RR | HR013RR | 6,7 |
| BB | HR013BB | 6,7 |

PACKAGING

L: 80 mm
D: 80 mm
H: 365 mm

0,8 kg

ARTICLE | ARTICOLO | ARTICLE

HR011

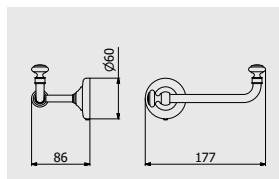

Toilet paper holder

Porta rotolo

Porte rouleaux de toilette

| CODICE / COEFFICIENTE | CODE / COEFFICIENT | |
|-----------------------|--------------------|-----|
| CC | HR011CC | 2,9 |
| PL | HR011PL | 4,6 |
| SS | HR011SS | 3,6 |
| II | HR011II | 4,4 |
| RS | HR011RS | 4,4 |
| OS | HR011OS | 4,6 |
| RR | HR011RR | 4,1 |
| BB | HR011BB | 4,1 |

PACKAGING

L: 195 mm
D: 85 mm
H: 80 mm

0,5 kg



Hermes

KUSASI / KUSASI SHORT

A small wave that interrupt the straight trait.

Una piccola onda che interferisce interrompendo la linea retta.
Une petite onde qui interfère en interrompant la ligne droite.

A fragmented line, a small wave that interferes interrupting the straight trait: the Kusasi collection represents the contrast between a squared and linear volume and a curvilinear rebel detail, that interrupts its geometry by softening it. The traditional lever can be replaced by a shorter one, accentuating the sinuous wavy features.

Un tratto non lineare, una piccola onda che interferisce interrompendo la linea retta: la collezione Kusasi rappresenta il contrasto tra un volume squadrato e lineare e un particolare curvilineo ribelle, che ne interrompe la geometria, ammorbidendola. La leva tradizionale può essere sostituita da una più corta, ad accentuare il sinuoso tratto ondivago.

Un trait non linéaire, une petite onde qui interfère en interrompant la ligne droite: la collection Kusasi représente le contraste entre un volume carré et linéaire et un détail curviligne rebelle, qui interrompt sa géométrie et l'adoucit. Le levier traditionnel peut être remplacé par un levier plus court, pour accentuer la sinieuse ligne ondulée.



KITCHEN
AVAILABLE



DOUBLE LEVER



LEAD FREE



ZINC FREE





Kusasi

DESIGN
MAURIZIO DURANTI



- ↑ KU200CC
 Monohole washbasin mixer
 Miscelatore lavabo monoforo
 Mitigeur lavabo
- ↙ KS203CC
 Monohole washbasin mixer
 Miscelatore lavabo monoforo
 Mitigeur lavabo
- KU202SS
 Tall monohole washbasin mixer
 Miscelatore lavabo monoforo alto
 Mitigeur lavabo haut







← KU299CC
Monohole free-standing washbasin mixer
Miscelatore lavabo da terra
Mitigeur Lavabo Free standing

↗ KS201CC
Mini monohole washbasin mixer
Miscelatore lavabo monoforo mini
Mitigeur lavabo Mini

→ KU206CC
Wall mounted washbasin mixer
Miscelatore lavabo due fori a parete
Mitigeur lavabo mural



Kusasi



↖ **KU314CC**
Three ways wall shower mixer complete with shower kit
 Miscelatore doccia a parete con deviatore tre vie e doccino integrato
 Mitigeur douche mural trois voies avec inverseur et douchette encastrée

← **KS314CC**
Three ways wall shower mixer complete with shower kit
 Miscelatore doccia a parete con deviatore tre vie e doccino integrato
 Mitigeur douche mural trois voies avec inverseur et douchette encastrée

↗ **KU350CC**
Wall mounted shower mixer with shower kit
 Doccia esterno a parete completo di kit doccia
 Mitigeur de douche externe avec flexible et douchette



Kusasi





← **KU399CC**
Free-standing bath filler with shower kit
Bordo vasca da terra con kit doccia
Bain douche complet alimentation au sol

↑ **KU250CC**
Wall mounted bath filler complete with hand shower kit
Bordo vasca esterno a parete completo di kit doccia
Mitigeur Bain/douche Mural avec douchette encastrée

→ **KU706CC**
Exposed parts for bidet spray complete with mixer
Set di parti esterne per Idroscopino igienico con miscelatore
Partie extérieure pour douchette hygiénique avec mitigeur



Kusasi

LEVER | LEVA | LEVIER

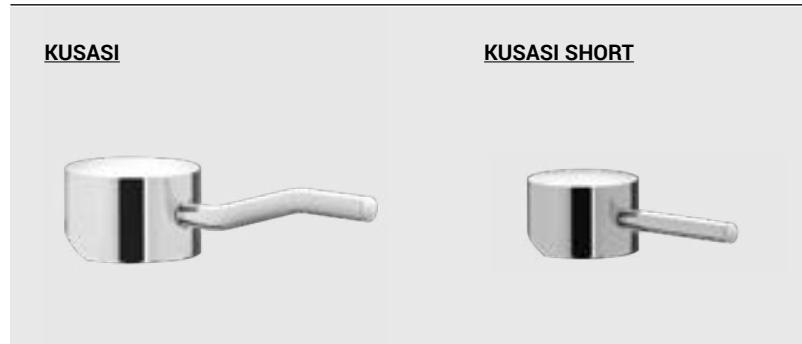

ARTICLE | ARTICOLO | ARTICLE

KU200 / KS200



Monohole washbasin mixer complete with drain

Miscelatore lavabo monoforo completo di scarico automatico

Mitigeur Lavabo complet avec bonde automatique

CODE / COEFFICIENT | CODICE / COEFFICIENTE |
CODE / COEFFICIENT

| | CC | SS | NP | KU200CC | KS200CC | KU200SS | KS200SS | KU200NP | KS200NP | |
|--|----|----|----|---------|---------|---------|---------|---------|---------|-----|
| | | | | | | | | | | 5,7 |
| | | | | | | | | | | 7,1 |
| | | | | | | | | | | 6,8 |

PACKAGING

L: 340 mm
D: 180 mm
H: 70 mm

2,0 kg

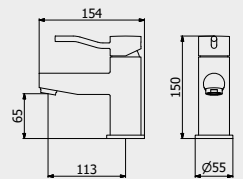

PORTATE | WATER FLOW | DÉBIT D'EAU

| 1 BAR | 2 BAR | 3 BAR |
|-------|--------|--------|
| 9 l/m | 12 l/m | 15 l/m |

ARTICLE | ARTICOLO | ARTICLE

KS201



Mini monohole washbasin mixer complete with drain

Miscelatore lavabo monoforo mini completo di scarico automatico

Mitigeur lavabo Mini complet avec bonde automatique

CODE / COEFFICIENT | CODICE / COEFFICIENTE |
CODE / COEFFICIENT

| | CC | SS | NP | KS201CC | KS201SS | KS201NP | |
|--|----|----|----|---------|---------|---------|-----|
| | | | | | | | 5,2 |
| | | | | | | | 6,5 |
| | | | | | | | 6,2 |

PACKAGING

L: 340 mm
D: 180 mm
H: 70 mm

1,7 kg

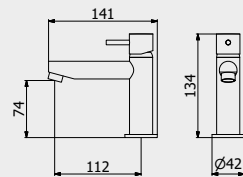

PORTATE | WATER FLOW | DÉBIT D'EAU

| 1 BAR | 2 BAR | 3 BAR |
|-------|--------|--------|
| 9 l/m | 12 l/m | 15 l/m |

ARTICLE | ARTICOLO | ARTICLE

KU202 / KS202



Tall monohole washbasin mixer complete with drain

Miscelatore lavabo alto monoforo completo di scarico automatico

Mitigeur Lavabo haut complet avec bonde automatique

CODE / COEFFICIENT | CODICE / COEFFICIENTE |
CODE / COEFFICIENT

| | CC | SS | NP | KU202CC | KS202CC | KU202SS | KS202SS | KU202NP | KS202NP | |
|--|----|----|----|---------|---------|---------|---------|---------|---------|------|
| | | | | | | | | | | 9,7 |
| | | | | | | | | | | 12,1 |
| | | | | | | | | | | 11,6 |

PACKAGING

L: 455 mm
D: 310 mm
H: 75 mm

3,5 kg

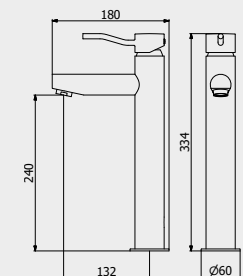

PORTATE | WATER FLOW | DÉBIT D'EAU

| 1 BAR | 2 BAR | 3 BAR |
|-------|--------|--------|
| 9 l/m | 12 l/m | 15 l/m |



ARTICLE | ARTICOLO | ARTICLE

KS203



Mini tall monohole washbasin mixer complete with drain
 Miscelatore lavabo alto monoforo mini completo di scarico automatico
 Mitigeur lavabo Mini haut complet avec bonde automatique

| CODE / COEFFICIENT | CODICE / COEFFICIENTE | |
|--------------------|-----------------------|------|
| CC | KS203CC | 8,8 |
| SS | KU203SS | 10,9 |
| NP | KU203NP | 10,5 |

PACKAGING

L: 455 mm
 D: 310 mm
 H: 75 mm
 3,3 kg

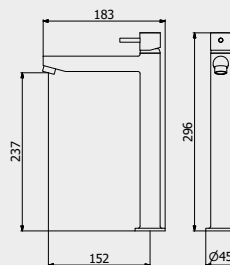

PORTATE | WATER FLOW | DÉBIT D'EAU

| 1 BAR | 2 BAR | 3 BAR |
|-------|--------|--------|
| 7 l/m | 10 l/m | 13 l/m |

ARTICLE | ARTICOLO | ARTICLE

KU206 / KS206



Wall mounted washbasin mixer complete with drain
 Miscelatore lavabo due fori a parete completo di scarico automatico
 Mitigeur lavabo mural complet avec bonde automatique

| CODE / COEFFICIENT | CODICE / COEFFICIENTE | |
|--------------------|-----------------------|--|
|--------------------|-----------------------|--|

| | | | |
|----|----------|----------|------|
| CC | EKU206CC | EKS206CC | 8,4 |
| SS | EKU206SS | EKS206SS | 10,5 |
| NP | EKU206NP | EKS206NP | 10,1 |

PACKAGING

L: 265 mm
 D: 260 mm
 H: 70 mm
 1,2 kg

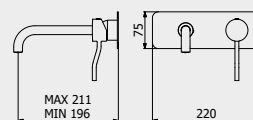

PORTATE | WATER FLOW | DÉBIT D'EAU

| 1 BAR | 2 BAR | 3 BAR |
|---------|----------|--------|
| 7,6 l/m | 10,5 l/m | 13 l/m |

Built-in body to be purchased separately

Corpo incasso da acquistare separatamente
 Corps intégré à acheter séparément



CODICE | CODE | CODE

INC206XXXN_19

COEFFICIENTE | COEFFICIENT | COEFFICIENT

2,9



ARTICLE | ARTICOLO | ARTICLE

KU207 / KS207



Wall mounted washbasin mixer with long spout complete with drain
 Miscelatore lavabo due fori a parete con bocca lunga completo di scarico
 Mitigeur lavabo mural bec long complet avec bonde automatique

| CODE / COEFFICIENT | CODICE / COEFFICIENTE | |
|--------------------|-----------------------|--|
|--------------------|-----------------------|--|

| | | | |
|----|----------|----------|------|
| CC | EKU207CC | EKS207CC | 9,6 |
| SS | EKU207SS | EKS207SS | 12,0 |
| NP | EKU207NP | EKS207NP | 11,5 |

PACKAGING

L: 265 mm
 D: 260 mm
 H: 70 mm
 1,2 kg

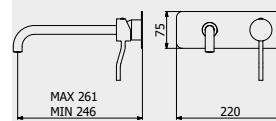

PORTATE | WATER FLOW | DÉBIT D'EAU

| 1 BAR | 2 BAR | 3 BAR |
|---------|----------|--------|
| 7,6 l/m | 10,5 l/m | 13 l/m |

Built-in body to be purchased separately

Corpo incasso da acquistare separatamente
 Corps intégré à acheter séparément



CODICE | CODE | CODE

INC206XXXN_19

COEFFICIENTE | COEFFICIENT | COEFFICIENT

2,9



Kusasi

ARTICLE | ARTICOLO | ARTICLE

KU208 / KS208



Wall mounted washbasin mixer with short spout complete with drain
 Miscelatore lavabo due fori a parete con bocca corta completo di scarico
 Mitigeur lavabo mural bec court complet avec bonde automatique

CODE / COEFFICIENT | CODICE / COEFFICIENTE |
 CODE / COEFFICIENT

| | CC | SS | NP | EKU208CC | EKS208CC | EKU208SS | EKS208SS | EKU208NP | EKS208NP | |
|--|----|----|----|----------|----------|----------|----------|----------|----------|------|
| | ● | ● | ● | | | | | | | 9,6 |
| | ● | ● | ● | | | | | | | 12,0 |
| | ● | ● | ● | | | | | | | 11,5 |

PACKAGING
 L: 265 mm
 D: 260 mm
 H: 70 mm
 1,2 kg

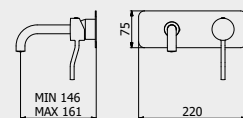

PORTATE | WATER FLOW | DÉBIT D'EAU

| | | |
|---------|----------|--------|
| 1 BAR | 2 BAR | 3 BAR |
| 7,6 l/m | 10,5 l/m | 13 l/m |

Built-in body to be purchased separately

Corpo incasso da acquistare separatamente

Corps intégré à acheter séparément



CODICE | CODE | CODE

INC206XXXN_19

COEFFICIENTE | COEFFICIENT | COEFFICIENT

2,9



ARTICLE | ARTICOLO | ARTICLE

KU210 / KS210

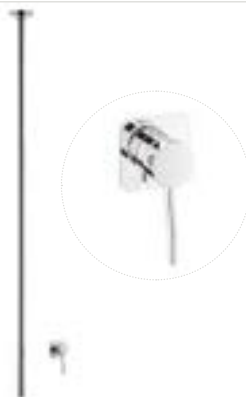

Ceiling spout with wall mounted mixer
 Bocca da soffitto con comando remoto ad incasso
 Mitigeur lavabo mural avec bec plafond complet avec bonde automatique

CODE / COEFFICIENT | CODICE / COEFFICIENTE |
 CODE / COEFFICIENT

| | CC | SS | NP | EKU210CC | EKS210CC | EKU210SS | EKS210SS | EKU210NP | EKS210NP | |
|--|----|----|----|----------|----------|----------|----------|----------|----------|------|
| | ● | ● | ● | | | | | | | 27,5 |
| | ● | ● | ● | | | | | | | 34,4 |
| | ● | ● | ● | | | | | | | 33,0 |

PACKAGING
 L: 150 mm
 D: 190 mm
 H: 98 mm
 L: 1700 mm
 Ø: 70 mm
 4,5 kg

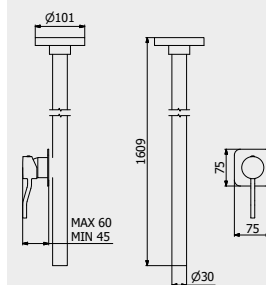

PORTATE | WATER FLOW | DÉBIT D'EAU

| | | |
|---------|---------|-------|
| 1 BAR | 2 BAR | 3 BAR |
| 4,3 l/m | 5,2 l/m | 7 l/m |

Built-in body to be purchased separately

Corpo incasso da acquistare separatamente

Corps intégré à acheter séparément



CODICE | CODE | CODE

INC300XXXN_19

COEFFICIENTE | COEFFICIENT | COEFFICIENT

1,8

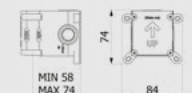

ARTICLE | ARTICOLO | ARTICLE

KU299 / KS299



Monohole free-standing washbasin mixer complete with drain
 Miscelatore lavabo da terra completo di scarico automatico
 Mitigeur lavabo free standing complet avec bonde automatique

CODE / COEFFICIENT | CODICE / COEFFICIENTE |
 CODE / COEFFICIENT

| | CC | SS | NP | EKU299CC | EKS299CC | EKU299SS | EKS299SS | EKU299NP | EKS299NP | |
|--|----|----|----|----------|----------|----------|----------|----------|----------|------|
| | ● | ● | ● | | | | | | | 23,1 |
| | ● | ● | ● | | | | | | | 28,9 |
| | ● | ● | ● | | | | | | | 27,7 |

PACKAGING
 L: 782 mm
 D: 133 mm
 H: 80 mm
 9,3 kg

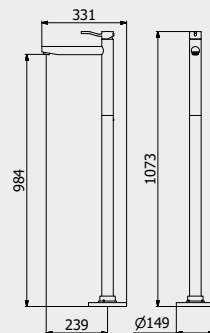

PORTATE | WATER FLOW | DÉBIT D'EAU

| | | |
|----------|----------|----------|
| 1 BAR | 2 BAR | 3 BAR |
| 10,4 l/m | 11,5 l/m | 15,5 l/m |

Built-in body to be purchased separately
 AVAILABLE FROM JANUARY 2020

Corpo incasso da acquistare separatamente
 DISPONIBILE DA GENNAIO 2020

Corps intégré à acheter séparément
 DISPONIBLE À PARTIR DE JANVIER 2020



CODICE | CODE | CODE

INC399XXXN_19

COEFFICIENTE | COEFFICIENT | COEFFICIENT

2,8

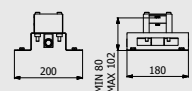

ARTICLE | ARTICOLO | ARTICLE

KU390 / KS390



Three holes washbasin set with tall spout

Lavabo tre fori bocca alta completo di scarico automatico

Lavabo trois trous bec haut

CODE / COEFFICIENT | CODICE / COEFFICIENTE |
CODE / COEFFICIENT

| | CC | KS390CC | 18,8 |
|---|----|---------|------|
| ● | SS | KU390SS | 23,4 |
| ● | NP | KU390NP | 22,5 |

PACKAGING

| | |
|----|-----------|
| 📦 | L: 455 mm |
| | D: 310 mm |
| | H: 75 mm |
| ⚖️ | 5,2 kg |

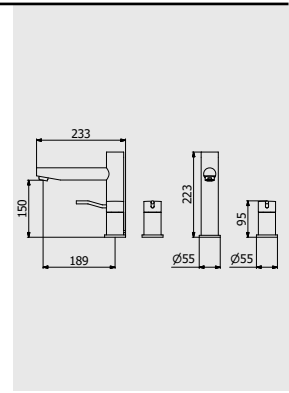

PORTATE | WATER FLOW | DÉBIT D'EAU

| | | |
|----------|----------|--------|
| 1 BAR | 2 BAR | 3 BAR |
| 10,3 l/m | 14,5 l/m | 18 l/m |

ARTICLE | ARTICOLO | ARTICLE

KU392 / KS392



Three holes washbasin set with low spout

Lavabo tre fori a bocca bassa completo di scarico automatico

Lavabo trois trous bec bas

CODE / COEFFICIENT | CODICE / COEFFICIENTE |
CODE / COEFFICIENT

| | CC | KS392CC | 15,1 |
|---|----|---------|------|
| ● | SS | KU392SS | 18,9 |
| ● | NP | KU392NP | 18,2 |

PACKAGING

| | |
|----|-----------|
| 📦 | L: 370 mm |
| | D: 270 mm |
| | H: 80 mm |
| ⚖️ | 4,2 kg |

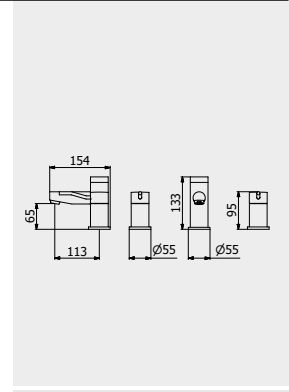

PORTATE | WATER FLOW | DÉBIT D'EAU

| | | |
|-------|--------|--------|
| 1 BAR | 2 BAR | 3 BAR |
| 9 l/m | 13 l/m | 18 l/m |

ARTICLE | ARTICOLO | ARTICLE

KU220 / KS220



Monohole bidet mixer complete with drain

Miscelatore bidet monoforo completo di scarico automatico

Mitigeur bidet complet avec bonde automatique

CODE / COEFFICIENT | CODICE / COEFFICIENTE |
CODE / COEFFICIENT

| | CC | KS220CC | 5,7 |
|---|----|---------|-----|
| ● | SS | KU220SS | 7,1 |
| ● | NP | KU220NP | 6,8 |

PACKAGING

| | |
|----|-----------|
| 📦 | L: 340 mm |
| | D: 180 mm |
| | H: 70 mm |
| ⚖️ | 1,8 kg |

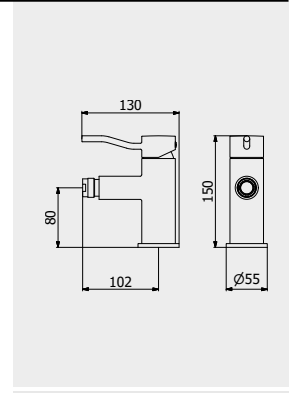

PORTATE | WATER FLOW | DÉBIT D'EAU

| | | |
|-------|--------|--------|
| 1 BAR | 2 BAR | 3 BAR |
| 9 l/m | 12 l/m | 15 l/m |

ARTICLE | ARTICOLO | ARTICLE

KU300 / KS300



Exposed parts for manual wall mixer

Set di parti esterne per miscelatore a parete ad una via

Partie extérieure pour mitigeur encastré à une voie

CODE / COEFFICIENT | CODICE / COEFFICIENTE |
CODE / COEFFICIENT

| | CC | EKU300CC | EKS300CC | 2,8 |
|--|----|----------|----------|-----|
| | SS | EKU300SS | EKS300SS | 3,5 |
| | NP | EKU300NP | EKS300NP | 3,4 |

PACKAGING

 L: 150 mm
D: 190 mm
H: 98 mm

1,2 kg

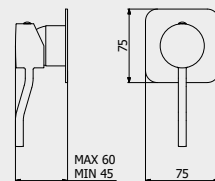

PORTATE | WATER FLOW | DÉBIT D'EAU

| 1 BAR | 2 BAR | 3 BAR |
|----------|----------|--------|
| 11,5 l/m | 16,3 l/m | 20 l/m |

Built-in body to be purchased separately

Corpo incasso da acquistare separatamente

Corps intégré à acheter séparément



CODICE | CODE | CODE

INC300XXXN_19

COEFFICIENTE | COEFFICIENT | COEFFICIENT

1,8



ARTICLE | ARTICOLO | ARTICLE

KU310 / KS310



Exposed parts for manual wall mixer with two ways diverter

Miscelatore doccia a parete con deviatore due vie

Mitigeur douche mural deux voies avec inverseur

CODE / COEFFICIENT | CODICE / COEFFICIENTE |
CODE / COEFFICIENT

| | CC | EKU310CC | EKS310CC | 5,0 |
|--|---|----------|----------|-----|
| | SS <th>EKU310SS</th> <th>EKS310SS</th> <td>6,3</td> | EKU310SS | EKS310SS | 6,3 |
| | NP <th>EKU310NP</th> <th>EKS310NP</th> <td>6,0</td> | EKU310NP | EKS310NP | 6,0 |

PACKAGING

 L: 150 mm
D: 190 mm
H: 98 mm

1,2 kg

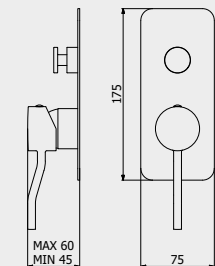

PORTATE | WATER FLOW | DÉBIT D'EAU

| 1 BAR | 2 BAR | 3 BAR |
|---------|----------|--------|
| 9,2 l/m | 12,5 l/m | 16 l/m |

Built-in body to be purchased separately

Corpo incasso da acquistare separatamente

Corps intégré à acheter séparément



CODICE | CODE | CODE

INC310XXXN_19

COEFFICIENTE | COEFFICIENT | COEFFICIENT

3,3

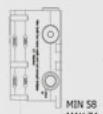

ARTICLE | ARTICOLO | ARTICLE

KU312 / KS312



Exposed parts for manual wall mixer with three ways diverter

Set di parti esterne per miscelatore a parete a tre vie

Mitigeur douche mural trois voies avec inverseur

CODE / COEFFICIENT | CODICE / COEFFICIENTE |
CODE / COEFFICIENT

| | CC | EKU312CC | EKS312CC | 6,3 |
|--|---|----------|----------|-----|
| | SS <th>EKU312SS</th> <th>EKS312SS</th> <td>7,9</td> | EKU312SS | EKS312SS | 7,9 |
| | NP <th>EKU312NP</th> <th>EKS312NP</th> <td>7,6</td> | EKU312NP | EKS312NP | 7,6 |

PACKAGING

 L: 150 mm
D: 190 mm
H: 98 mm

1,2 kg

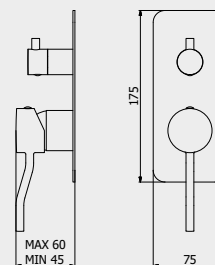

PORTATE | WATER FLOW | DÉBIT D'EAU

| 1 BAR | 2 BAR | 3 BAR |
|---------|----------|----------|
| 8,3 l/m | 11,7 l/m | 14,3 l/m |

Built-in body to be purchased separately

Corpo incasso da acquistare separatamente

Corps intégré à acheter séparément



CODICE | CODE | CODE

INC312XXXN_19

COEFFICIENTE | COEFFICIENT | COEFFICIENT

3,3



ARTICLE | ARTICOLO | ARTICLE

KU313 / KS313



Exposed parts for manual wall mixer with 2 ways with shower kit
 Set di parti esterne per miscelatore a parete a due vie completo di kit doccia
 Partie extérieure pour mitigeur encastré à deux voies avec douchette

CODE / COEFFICIENT | CODICE / COEFFICIENTE | PACKAGING
 CODE / COEFFICIENT

| | CC | EKU313CC | EKS313CC | 10,1 | L: 370 mm D: 270 mm H: 80 mm 1,9 kg |
|--|----|----------|----------|------|--|
| | SS | EKU313SS | EKS313SS | 12,6 | |
| | NP | EKU313NP | EKS313NP | 12,1 | |

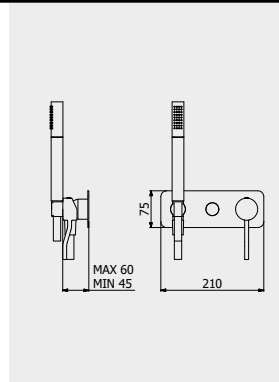

PORTATE | WATER FLOW | DÉBIT D'EAU

| 1 BAR | 2 BAR | 3 BAR |
|--------|----------|----------|
| 10 l/m | 14,1 l/m | 17,1 l/m |

Built-in body to be purchased separately

Corpo incasso da acquistare separatamente

Corps intégré à acheter séparément



CODICE | CODE | CODE

INC313XXXN_19

COEFFICIENTE | COEFFICIENT | COEFFICIENT

3,6

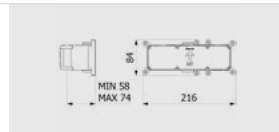

ARTICLE | ARTICOLO | ARTICLE

KU314 / KS314



Exposed parts for manual wall mixer with 3 ways with shower kit
 Set di parti esterne per miscelatore a parete a tre vie completo di kit doccia
 Partie extérieure pour mitigeur encastré à trois voies avec douchette

CODE / COEFFICIENT | CODICE / COEFFICIENTE | PACKAGING
 CODE / COEFFICIENT

| | CC | EKU314CC | EKS314CC | 11,4 | L: 370 mm D: 270 mm H: 80 mm 1,9 kg |
|--|----|----------|----------|------|--|
| | SS | EKU314SS | EKS314SS | 14,3 | |
| | NP | EKU314NP | EKS314NP | 13,7 | |

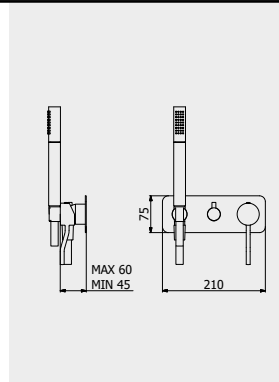

PORTATE | WATER FLOW | DÉBIT D'EAU

| 1 BAR | 2 BAR | 3 BAR |
|---------|----------|----------|
| 9,5 l/m | 13,4 l/m | 16,9 l/m |

Built-in body to be purchased separately

Corpo incasso da acquistare separatamente

Corps intégré à acheter séparément



CODICE | CODE | CODE

INC314XXXN_19

COEFFICIENTE | COEFFICIENT | COEFFICIENT

3,7

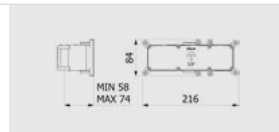

ARTICLE | ARTICOLO | ARTICLE

KU250 / KS250



Wall mounted bath filler complete with hand shower kit
 Bordo vasca esterno a parete completo di kit doccia
 Mitigeur Bain/douche Mural avec douchette encastrée

CODE / COEFFICIENT | CODICE / COEFFICIENTE | PACKAGING
 CODE / COEFFICIENT

| | CC | KU250CC | KS250CC | 8,7 | L: 220 mm D: 200 mm H: 150 mm 2,5 kg |
|--|----|---------|---------|------|---|
| | SS | KU250SS | KS250SS | 10,9 | |
| | NP | KU250NP | KS250NP | 10,4 | |

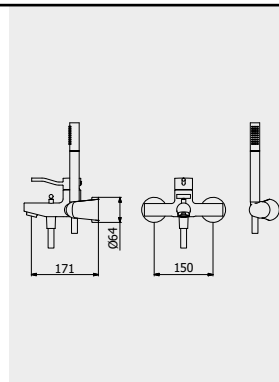

PORTATE | WATER FLOW | DÉBIT D'EAU

| 1 BAR | 2 BAR | 3 BAR |
|--------|----------|--------|
| 10 l/m | 14,3 l/m | 18 l/m |

Kusasi

ARTICLE | ARTICOLO | ARTICLE

KU350 / KS350



Wall mounted shower mixer with shower kit

Doccia esterno a parete completo di kit doccia

Mitigeur de douche externe avec flexible et douchette

CODE / COEFFICIENT | CODICE / COEFFICIENTE |
CODE / COEFFICIENT

| | CC | KU250CC | KS250CC | 6,8 |
|--|----|---------|---------|-----|
| | SS | KU250SS | KS250SS | 8,5 |
| | NP | KU250NP | KS250NP | 8,2 |

PACKAGING

L: 220 mm
D: 200 mm
H: 150 mm

1,7 kg

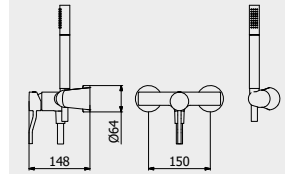

PORTATE | WATER FLOW | DÉBIT D'EAU

| 1 BAR | 2 BAR | 3 BAR |
|--------|--------|--------|
| 10 l/m | 15 l/m | 18 l/m |

ARTICLE | ARTICOLO | ARTICLE

KU396 / KS396



Four holes deck mounted bath filler with shower kit

Bordo vasca quattro fori con deviatore e kit doccia

Bain/douche quatre trous avec inverseur et Kit Douche

CODE / COEFFICIENT | CODICE / COEFFICIENTE |
CODE / COEFFICIENT

| | CC | KU396CC | KS396CC | 20,6 |
|--|----|---------|---------|------|
| | SS | KU396SS | KS396SS | 25,8 |
| | NP | KU396NP | KS396NP | 24,7 |

PACKAGING

L: 455 mm
D: 310 mm
H: 75 mm

6,2 kg

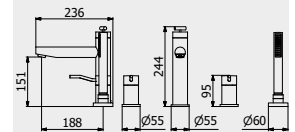

PORTATE | WATER FLOW | DÉBIT D'EAU

| 1 BAR | 2 BAR | 3 BAR |
|--------|--------|----------|
| 11 l/m | 15 l/m | 20,5 l/m |

ARTICLE | ARTICOLO | ARTICLE

KU397 / KS397



4 holes bath filler with overflow outlet connection, diverter and shower kit

Bordo vasca 4 fori per colonna riempimento con deviatore e kit doccia

Bain/douche 4 trous avec inverseur et Kit Douche pour remplissage ETP

CODE / COEFFICIENT | CODICE / COEFFICIENTE |
CODE / COEFFICIENT

| | CC | KU397CC | KS397CC | 14,9 |
|--|----|---------|---------|------|
| | SS | KU397SS | KS397SS | 18,6 |
| | NP | KU397NP | KS397NP | 17,9 |

PACKAGING

L: 455 mm
D: 310 mm
H: 75 mm

4,7 kg

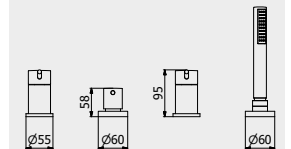

PORTATE | WATER FLOW | DÉBIT D'EAU

| 1 BAR | 2 BAR | 3 BAR |
|----------|-------|----------|
| 10,5 l/m | 5 l/m | 20,5 l/m |



ARTICLE | ARTICOLO | ARTICLE

KU399 / KS399



Free-standing bath filler with shower kit
Bordo vasca da terra con kit doccia
Bain douche complet alimentation au sol

CODICE / COEFFICIENT | CODICE / COEFFICIENTE |
CODE / COEFFICIENT

| | CC | EKU399CC | EKS399CC | 25,3 | | |
|--|----|----------|----------|------|--|--|
| | SS | EKU399SS | EKS399SS | 31,6 | | |
| | NP | EKU399NP | EKS399NP | 30,4 | | |

PACKAGING
L: 1100 mm
D: 395 mm
H: 150 mm
7,9 kg

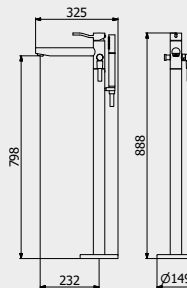

PORTATE | WATER FLOW | DÉBIT D'EAU

| 1 BAR | 2 BAR | 3 BAR |
|----------|--------|----------|
| 11,2 l/m | 16 l/m | 19,5 l/m |

Built-in body to be purchased separately
AVAILABLE FROM JANUARY 2020
Corpo incasso da acquistare separatamente
DISPONIBILE DA GENNAIO 2020
Corps intégré à acheter séparément
DISPONIBLE À PARTIR DE JANVIER 2020



CODICE | CODE | CODE

INC399XXXN_19

COEFFICIENTE | COEFFICIENT | COEFFICIENT

2,8

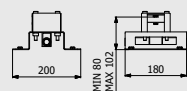

ARTICLE | ARTICOLO | ARTICLE

MT320



Wall mounted spout
Bocca d'erogazione a parete
Bec de remplissage mural

CODICE / COEFFICIENTE | CODE /
COEFFICIENT | CODE / COEFFICIENT

| | CC | MT320CC | 2,1 | | |
|--|--|---------|-----|--|--|
| | NP | MT250NP | 2,6 | | |
| | SS <th>MT320SS</th> <td>2,5</td> <td></td> <td></td> | MT320SS | 2,5 | | |

PACKAGING
L: 150 mm
D: 190 mm
H: 98 mm
0,2 kg

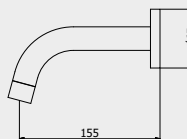

PORTATE | WATER FLOW | DÉBIT D'EAU

| 1 BAR | 2 BAR | 3 BAR |
|---------|----------|----------|
| 9,9 l/m | 13,8 l/m | 16,8 l/m |

ARTICLE | ARTICOLO | ARTICLE

MT321



Short wall mounted spout
Bocca d'erogazione corta a parete
Bec de remplissage mural court

CODICE / COEFFICIENTE | CODE /
COEFFICIENT | CODE / COEFFICIENT

| | CC | MT321CC | 2,5 | | |
|--|--|---------|-----|--|--|
| | PL <th>MT321PL</th> <td>3,1</td> <td></td> <td></td> | MT321PL | 3,1 | | |
| | SS <th>MT321SS</th> <td>3,0</td> <td></td> <td></td> | MT321SS | 3,0 | | |

PACKAGING
L: 150 mm
D: 190 mm
H: 98 mm
0,2 kg

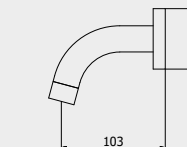

PORTATE | WATER FLOW | DÉBIT D'EAU

| 1 BAR | 2 BAR | 3 BAR |
|---------|----------|----------|
| 9,9 l/m | 13,8 l/m | 16,8 l/m |

ARTICLE | ARTICOLO | ARTICLE

MT322



Long wall mounted spout
Bocca d'erogazione lunga a parete
Bec de remplissage mural long

CODICE / COEFFICIENTE | CODE /
COEFFICIENT | CODE / COEFFICIENT

| | CC | MT322CC | 2,5 | | |
|--|--|---------|-----|--|--|
| | PL <th>MT322PL</th> <td>3,1</td> <td></td> <td></td> | MT322PL | 3,1 | | |
| | SS <th>MT322SS</th> <td>3,0</td> <td></td> <td></td> | MT322SS | 3,0 | | |

PACKAGING
L: 150 mm
D: 190 mm
H: 98 mm
0,2 kg

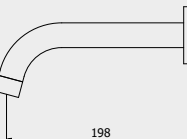

PORTATE | WATER FLOW | DÉBIT D'EAU

| 1 BAR | 2 BAR | 3 BAR |
|---------|----------|----------|
| 9,9 l/m | 13,8 l/m | 16,8 l/m |

Kusasi

ARTICLE | ARTICOLO | ARTICLE

KU706 / KS706



Exposed parts for bidet spray complete with mixer

Set di parti esterne per Idroscopino igienico con miscelatore

Partie extérieure pour douchette hygiénique avec mitigeur

CODE / COEFFICIENT | CODICE / COEFFICIENTE |
CODE / COEFFICIENT

| | CC | EKU706CC | EKS706CC | 8,4 |
|--|----|----------|----------|------|
| | SS | EKU706SS | EKS706SS | 10,5 |
| | NP | EKU706NP | EKS706NP | 10,1 |

PACKAGING

L: 370 mm
D: 270 mm
H: 80 mm

3,1 kg

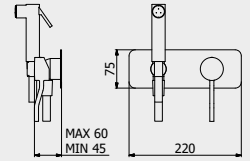

PORTATE | WATER FLOW | DÉBIT D'EAU

| 1 BAR | 2 BAR | 3 BAR |
|---------|---------|-------|
| 2,3 l/m | 3,2 l/m | 4 l/m |

Built-in body to be purchased separately

Corpo incasso da acquistare separatamente

Corps intégré à acheter séparément



CODICE | CODE | CODE

INC206XXXN_19

COEFFICIENTE | COEFFICIENT | COEFFICIENT

2,9



ARTICLE | ARTICOLO | ARTICLE

KU370 / KS370



Single Lever kitchen mixer

Lavello monoforo

Évier de cuisine

CODE / COEFFICIENT | CODICE / COEFFICIENTE |
CODE / COEFFICIENT

| | CC | KU370CC | KS370CC | 9,9 |
|--|--|---------|---------|------|
| | SS <th>KU370SS</th> <th>KS370SS</th> <td>12,4</td> | KU370SS | KS370SS | 12,4 |
| | NP <th>KU370NP</th> <th>KS370NP</th> <td>11,9</td> | KU370NP | KS370NP | 11,9 |

PACKAGING

L: 455 mm
D: 310 mm
H: 75 mm

3,6 kg

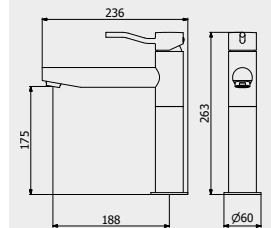

PORTATE | WATER FLOW | DÉBIT D'EAU

| 1 BAR | 2 BAR | 3 BAR |
|-------|--------|--------|
| 9 l/m | 13 l/m | 16 l/m |

ARTICLE | ARTICOLO | ARTICLE

KU385 / KS385



Side lever kitchen mixer

Miscelatore lavello monoforo con leva laterale

Évier de cuisine avec levier latéral

CODE / COEFFICIENT | CODICE / COEFFICIENTE |
CODE / COEFFICIENT

| | CC | KU385CC | KS385CC | 7,4 |
|--|---|---------|---------|-----|
| | SS <th>KU385SS</th> <th>KS385SS</th> <td>9,3</td> | KU385SS | KS385SS | 9,3 |
| | NP <th>KU385NP</th> <th>KS385NP</th> <td>8,9</td> | KU385NP | KS385NP | 8,9 |

PACKAGING

L: 370 mm
D: 270 mm
H: 80 mm

2,4 kg

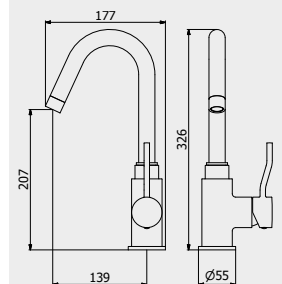

PORTATE | WATER FLOW | DÉBIT D'EAU

| 1 BAR | 2 BAR | 3 BAR |
|-------|----------|--------|
| 9 l/m | 12,5 l/m | 15 l/m |



MODERNA / ACCESSORIES COLLECTION

ARTICLE | ARTICOLO | ARTICLE

M0001

Wall soap-holder

Porta sapone a muro
Porte distributeur de savon encastré

CODE / COEFFICIENT | CODICE /
COEFFICIENTE | CODE / COEFFICIENT

CC M0001CC 1,5

PACKAGING

L: 110 mm
D: 130 mm
H: 50 mm

0,4 kg

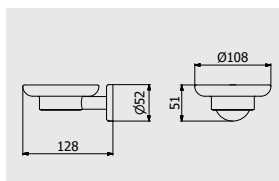

ARTICLE | ARTICOLO | ARTICLE

M0002

Wall soap dispenser holder

Porta dispenser sapone liquido a parete
Porte distributeur de savon en verre gravé

CODE / COEFFICIENT | CODICE /
COEFFICIENTE | CODE / COEFFICIENT

CC M0002CC 2,3

PACKAGING

L: 80 mm
D: 130 mm
H: 180 mm

0,1 kg

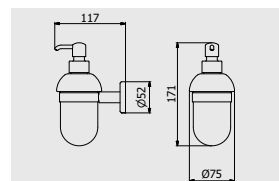

ARTICLE | ARTICOLO | ARTICLE

M0003

Wall toothbrush holder

Bicchiera porta spazzolino a parete
Porte-verre en verre gravé

CODE / COEFFICIENT | CODICE /
COEFFICIENTE | CODE / COEFFICIENT

CC M0003CC 1,5

PACKAGING

L: 70 mm
D: 110 mm
H: 100 mm

0,4 kg

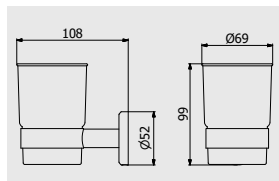

ARTICLE | ARTICOLO | ARTICLE

M0004

Towel holder

Porta salvietta
Porte-serviette

CODE / COEFFICIENT | CODICE /
COEFFICIENTE | CODE / COEFFICIENT

CC M0004CC 2,4

PACKAGING

L: 650 mm
D: 70 mm
H: 50 mm

0,5 kg

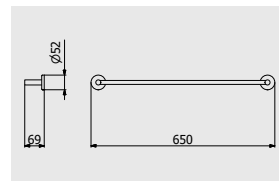

ARTICLE | ARTICOLO | ARTICLE

M0014

Towel holder

Porta salvietta
Porte-serviette

CODE / COEFFICIENT | CODICE /
COEFFICIENTE | CODE / COEFFICIENT

CC M0014CC 2,2

PACKAGING

L: 500 mm
D: 70 mm
H: 50 mm

0,5 kg

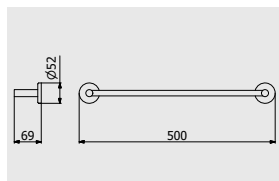

ARTICLE | ARTICOLO | ARTICLE

M0006

Towel holder

Porta salvietta
Porte-serviette

CODE / COEFFICIENT | CODICE /
COEFFICIENTE | CODE / COEFFICIENT

CC M0006CC 2,1

PACKAGING

L: 350 mm
D: 70 mm
H: 50 mm

0,4 kg

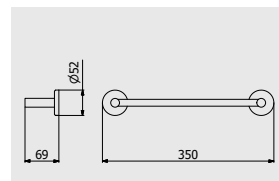

Kusasi

ARTICLE | ARTICOLO | ARTICLE

M0007



Ring Towel holder

Porta salvietta ad anello

Porte-serviette anneau

CODE / COEFFICIENT | CODICE /
COEFFICIENTE | CODE / COEFFICIENT

CC M0007CC 1,6

PACKAGING

L: 180 mm
D: 70 mm
H: 200 mm

0,8 kg

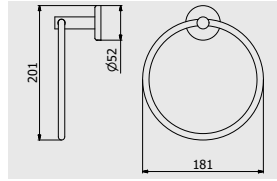

ARTICLE | ARTICOLO | ARTICLE

M0008



Robe Hook

Appendino a parete

Cintre

CODE / COEFFICIENT | CODICE /
COEFFICIENTE | CODE / COEFFICIENT

CC M0008CC 0,9

PACKAGING

L: 50 mm
D: 50 mm
H: 50 mm

0,3 kg

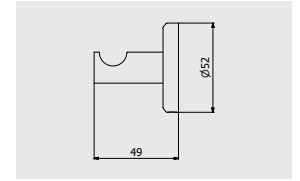

ARTICLE | ARTICOLO | ARTICLE

M0009



Double robe hook

Doppio appendino a parete

Double cintre

CODE / COEFFICIENT | CODICE /
COEFFICIENTE | CODE / COEFFICIENT

CC M0009CC 1,4

PACKAGING

L: 70 mm
D: 70 mm
H: 50 mm

0,1 kg

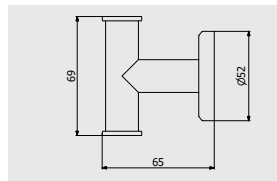

ARTICLE | ARTICOLO | ARTICLE

M0010



Shelf

Mensola

Etagère

CODE / COEFFICIENT | CODICE /
COEFFICIENTE | CODE / COEFFICIENT

CC M0010CC 3,0

PACKAGING

L: 600 mm
D: 140 mm
H: 50 mm

0,3 kg

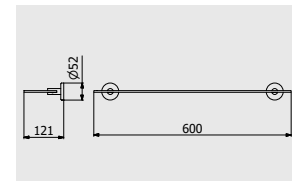

ARTICLE | ARTICOLO | ARTICLE

M0005



Swiveable towel holder

Porta salvietta doppio

Porte-serviette noeud

CODE / COEFFICIENT | CODICE /
COEFFICIENTE | CODE / COEFFICIENT

CC M0005CC 3,5

PACKAGING

L: 430 mm
D: 70 mm
H: 50 mm

0,5 kg

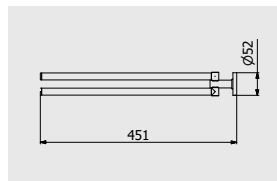

ARTICLE | ARTICOLO | ARTICLE

M0011



Toilet paper holder

Porta rotolo

Porte rouleaux de toilette

CODE / COEFFICIENT | CODICE /
COEFFICIENTE | CODE / COEFFICIENT

CC M0011CC 1,4

PACKAGING

L: 150 mm
D: 70 mm
H: 50 mm

0,2 kg

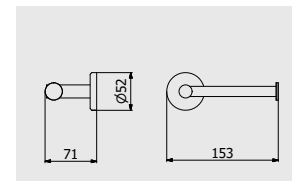

ARTICLE | ARTICOLO | ARTICLE

M0012



Toilet brush holder

Porta scopino da terra

Porte balayette au sol

CODE / COEFFICIENT | CODICE /
COEFFICIENTE | CODE / COEFFICIENT

CC M0012CC 2,5

PACKAGING

L: 80 mm
D: 80 mm
H: 380 mm

0,7 kg

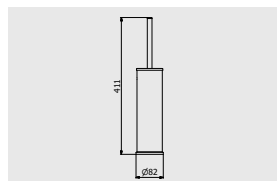

ARTICLE | ARTICOLO | ARTICLE

M0013



Wall toilet brush holder

Porta scopino da parete

Porte balayette

CODE / COEFFICIENT | CODICE /
COEFFICIENTE | CODE / COEFFICIENT

CC M0013CC 2,9

PACKAGING

L: 80 mm
D: 80 mm
H: 380 mm

0,7 kg

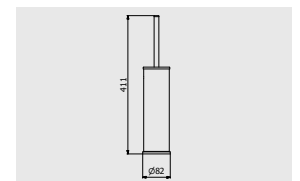

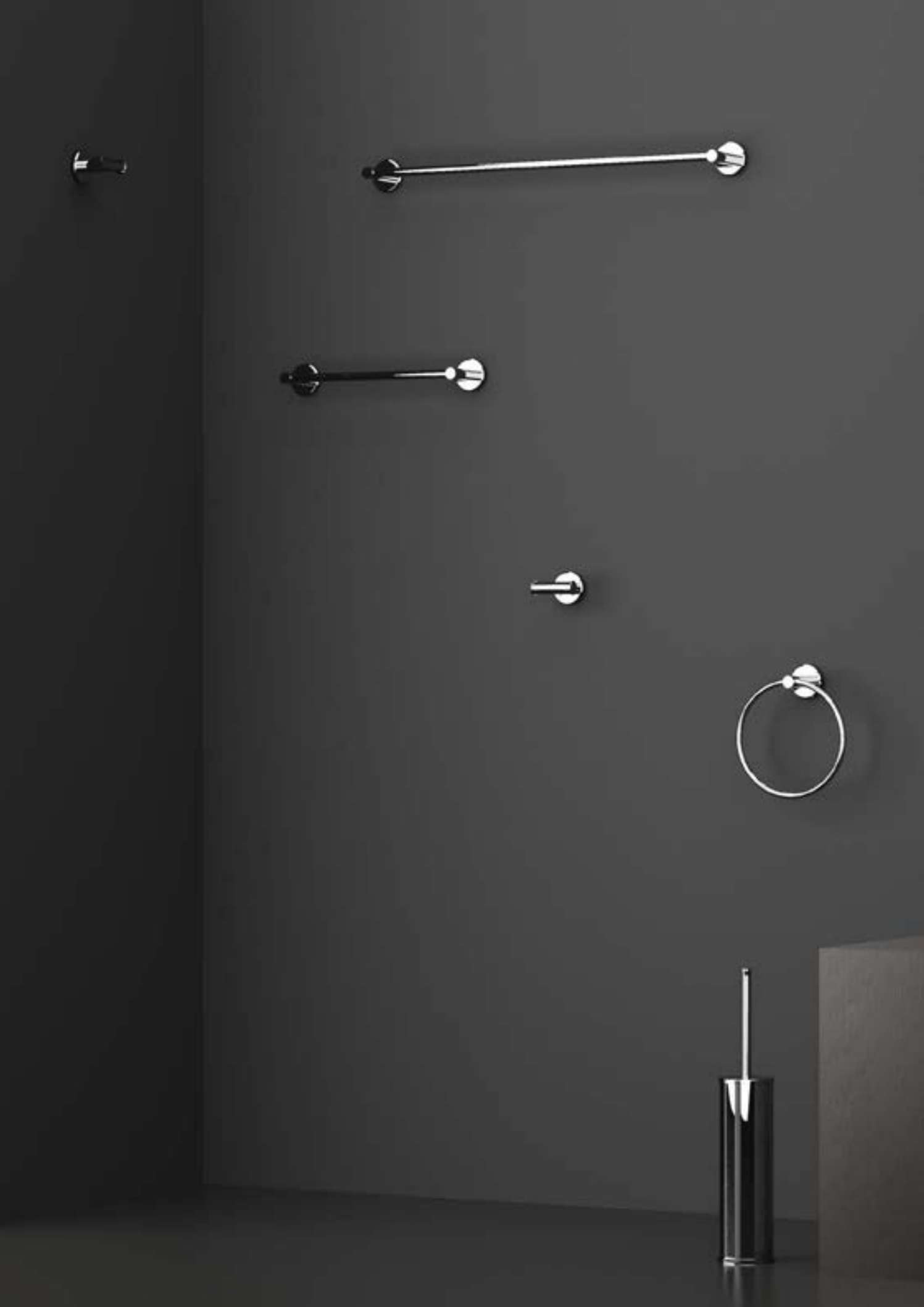

POWA

The smartest and most intuitive electronic faucets we've ever designed.

I rubinetti elettronici più intuitivi e intelligenti che abbiamo mai progettato.

Les robinets électroniques les plus intuitifs et intelligents que nous ayons jamais conçus

The POWA collection offers a range of four electronic mixers, washbasin or wall mounted washbasin, capable of combining technology and high functionality. By reducing water consumption thanks to its infrared electronic controls, the POWA collection makes its faucets perfect for all the public and commercial spaces.

La collezione POWA offre una gamma di quattro miscelatori elettrici, capaci di combinare innovazione tecnologica e alta funzionalità. Riducendo i consumi idrici grazie a comandi elettronici a infrarossi, la collezione POWA rende i suoi rubinetti perfetti per tutti gli spazi, privati e commerciali.

La collection POWA propose une gamme de quatre mitigeurs électroniques, lavabo ou lavabo mural, capables de combiner technologie et haute fonctionnalité. En réduisant la consommation d'eau grâce aux commandes électroniques infrarouges, la collection POWA rend ses robinets parfaits pour tous les espaces, publiques et commerciaux.



LEAD FREE



ZINC FREE



ELECTRONIC



ARTICLE | ARTICOLO | ARTICLE

EL001



Square wall mounted electronic mixer complete with stabilized power supply for mains
Miscelatore lavabo a parete quadro completo di centralina e comando a sensore.
Mitigeur de lavabo mural électroniques carré avec boîtier électrique et commande par capteur.

| CODICE / COEFFICIENTE | CODE / COEFFICIENT | |
|-----------------------|--------------------|------|
| CC | EL001CC | 62,5 |
| SS | EL001SS | 70,0 |
| BO | EL001BO | 70,0 |
| NP | EL001NP | 70,0 |
| CF | EL001CF | 70,0 |
| CS | EL001CS | 70,0 |
| II | EL001II | 70,0 |
| IS | EL001IS | 70,0 |
| RS | EL001RS | 70,0 |
| SR | EL001SR | 70,0 |
| OO | EL001OO | 70,0 |
| OS | EL001OS | 70,0 |

PACKAGING

L: 240 mm
D: 215 mm
H: 110 mm
2,5 kg

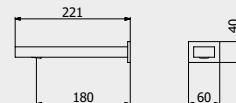

PORTATE | WATER FLOW | DÉBIT D'EAU

| | | |
|---------|-------|-------|
| 1 BAR | 2 BAR | 3 BAR |
| 4,5 l/m | 6 l/m | 6 l/m |

ARTICLE | ARTICOLO | ARTICLE

EL002



Round wall mounted electronic mixer complete with stabilized power supply for mains
Miscelatore lavabo a parete rotondo completo di centralina e comando a sensore.
Mitigeur de lavabo mural électroniques rond avec boîtier électrique et commande par capteur.

| CODICE / COEFFICIENTE | CODE / COEFFICIENT | |
|-----------------------|--------------------|------|
| CC | EL002CC | 62,5 |

PACKAGING

L: 240 mm
D: 215 mm
H: 110 mm
2,5 kg



PORTATE | WATER FLOW | DÉBIT D'EAU

| | | |
|---------|-------|-------|
| 1 BAR | 2 BAR | 3 BAR |
| 4,5 l/m | 6 l/m | 6 l/m |

ARTICLE | ARTICOLO | ARTICLE

EL003



Square electronic mixer complete with stabilized power supply for mains
Miscelatore lavabo quadro completo di centralina e comando a sensore.
Mitigeur de lavabo électroniques carré avec boîtier électrique et commande par capteur.

| CODICE / COEFFICIENTE | CODE / COEFFICIENT | |
|-----------------------|--------------------|------|
| CC | EL003CC | 62,5 |
| SS | EL003SS | 70,0 |
| BO | EL003BO | 70,0 |
| NP | EL003NP | 70,0 |
| CF | EL003CF | 70,0 |
| CS | EL003CS | 70,0 |
| II | EL003II | 70,0 |
| IS | EL003IS | 70,0 |
| RS | EL003RS | 70,0 |
| SR | EL003SR | 70,0 |
| OO | EL003OO | 70,0 |
| OS | EL003OS | 70,0 |

PACKAGING

L: 240 mm
D: 215 mm
H: 110 mm
2,5 kg

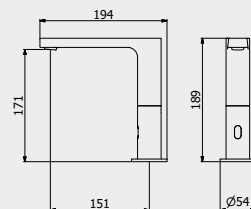

PORTATE | WATER FLOW | DÉBIT D'EAU

| | | |
|---------|-------|-------|
| 1 BAR | 2 BAR | 3 BAR |
| 4,5 l/m | 6 l/m | 6 l/m |

ARTICLE | ARTICOLO | ARTICLE

EL004



Round electronic mixer complete with stabilized power supply for mains
Miscelatore lavabo tondo completo di centralina e comando a sensore.
Mitigeur de lavabo électroniques rond avec boîtier électrique et commande par capteur.

| CODICE / COEFFICIENTE | CODE / COEFFICIENT | |
|-----------------------|--------------------|------|
| CC | EL004CC | 62,5 |
| SS | EL004SS | 70,0 |
| BO | EL004BO | 70,0 |
| NP | EL004NP | 70,0 |
| CF | EL004CF | 70,0 |
| CS | EL004CS | 70,0 |
| II | EL004II | 70,0 |
| IS | EL004IS | 70,0 |
| RS | EL004RS | 70,0 |
| SR | EL004SR | 70,0 |
| OO | EL004OO | 70,0 |
| OS | EL004OS | 70,0 |

PACKAGING

L: 240 mm
D: 215 mm
H: 110 mm
2,5 kg

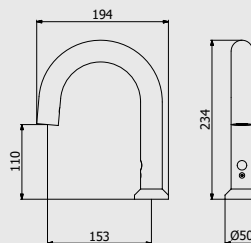

PORTATE | WATER FLOW | DÉBIT D'EAU

| | | |
|---------|-------|-------|
| 1 BAR | 2 BAR | 3 BAR |
| 4,5 l/m | 6 l/m | 6 l/m |

Powa

BYE BYE

Born to make a difference.

Progettato per fare la differenza.
Conçu pour faire la différence.

The BYE BYE cover plates are a perfect mix of efficiency and refinement. Compatible with the UP720 / Sigma 8 and UP320 / Sigma13 toilet tanks and equipped with a double water flush, they can be customized in thirteen finishes matching the faucet collections, for a flawless elegance in your bathroom.

Le placche BYE BYE sono un mix perfetto di efficacia e ricercatezza. Compatibili con le cassette UP720 / Sigma 8 e UP320 / Sigma13 e dotate di scarico con doppio volume d'acqua, sono personalizzabili in tredici finiture coordinate alle collezioni rubinetti, per un bagno impeccabile nella sua eleganza.

Les plaques BYE BYE allient parfaitement l'efficacité au raffinement. Compatibles avec les réservoirs de chasse UP720 / Sigma 8 et UP320 / Sigma13 et équipées de double débit d'eau, elles peuvent être personnalisées en treize finitions, coordonnées aux collections de robinets, pour une salle de bains d'une élégance impeccable.



DOUBLE WATER
FLUSH



5 mm
THICKNESS



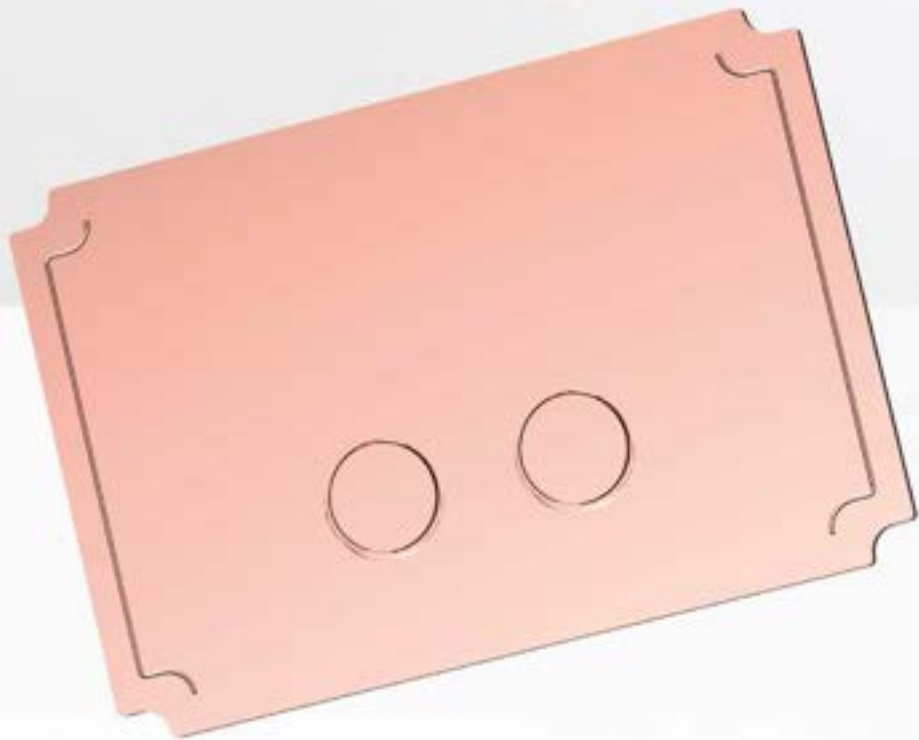
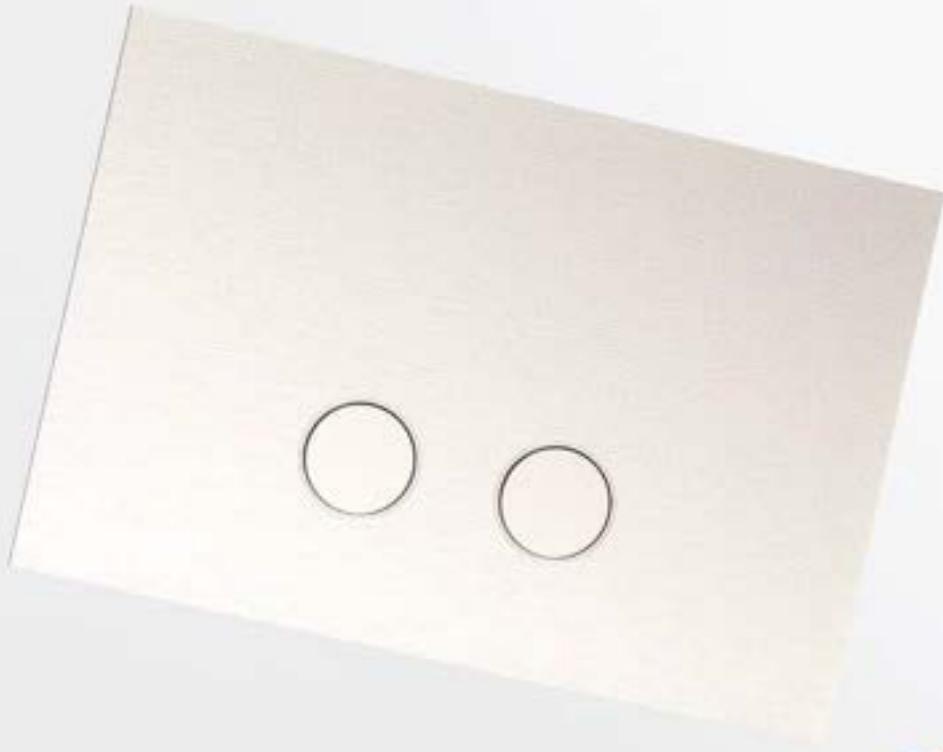

Bye Bye



ARTICLE | ARTICOLO | ARTICLE

BB001



WC cover plate "MODERNA" with double water flush

Placca per cassetta WC "MODERNA" a doppio volume d'acqua.

Plaque de chasse d'eau WC "MODERNA" à double débit d'eau

| CODE / COEFFICIENT | CODICE / COEFFICIENTE | |
|--------------------|-----------------------|------|
| CC | BB001CC | 12,5 |
| SS | BB001SS | 15,6 |
| ON | BB001ON | 12,5 |
| BO | BB001BO | 15,0 |
| NP | BB001NP | 15,0 |
| CF | BB001CF | 18,8 |
| CS | BB001CS | 20,0 |
| II | BB001II | 18,8 |
| IS | BB001IS | 20,0 |
| RS | BB001RS | 18,8 |
| SR | BB001SR | 20,0 |
| OO | BB001OO | 18,8 |
| OS | BB001OS | 20,0 |

PACKAGING

L: 350 mm
D: 270 mm
H: 45 mm

3,2 kg

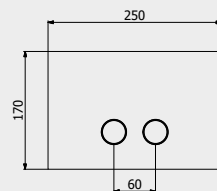

COMPATIBILITY | COMPATIBILITÀ | COMPATIBILITÉ

UP720 / sigma 8

UP320 / Sigma13

ARTICLE | ARTICOLO | ARTICLE

BB002



WC cover plate "HERMES - BIRKIN" with double water flush

Placca per cassetta WC "HERMES - BIRKIN" a doppio volume d'acqua.

Plaque de chasse d'eau WC "HERMES - BIRKIN" à double débit d'eau

| CODE / COEFFICIENT | CODICE / COEFFICIENTE | |
|--------------------|-----------------------|------|
| CC | BB002CC | 12,5 |
| PL | BB002PL | 20,0 |
| SS | BB002SS | 15,6 |
| II | BB002II | 18,8 |
| RS | BB002RS | 18,8 |
| OS | BB002OS | 20,0 |
| RR | BB002RR | 17,5 |
| BB | BB002BB | 17,5 |

PACKAGING

L: 350 mm
D: 270 mm
H: 45 mm

3,2 kg

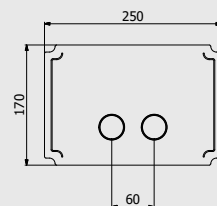

COMPATIBILITY | COMPATIBILITÀ | COMPATIBILITÉ

UP720 / sigma 8

UP320 / Sigma12



Bye Bye

THERMOSTATIQUE



AQUA
P. 526

SHOWER HEADS



AQUARIVA
P. 580



AQUABEAT
P. 592



ONAIR 2.0
P. 606



DROP
P. 612



MONAMOUR
SHOWER HEADS
+ ARMS
P. 618

SHOWER COLUMNS



WALLPAPER
P. 632



MONAMOUR
P. 638



OTHER
P. 642

SHOWER & CO.



HANDSHOWER
P. 652



DUPLEX
P. 654



SHOWER RAIL
P. 658



BODYJET
P. 660



SHUT OFF
P. 662



STOP VALVES
P. 663



WATER OUTLET
P. 664



BOTTLE TRAP
P. 665

SW

**SHOWER
DOCCIA
DOUCHE**

AQUA

The latest generation thermostatic valves collection.

La collezione di valvole termostatiche di ultima generazione.
La collection de vannes thermostatiques de dernière génération.

AQUA is a new-generation collection of high-performance thermostats, which guarantees perfect temperature and jet controls thanks to its universal built-in bodies. The result of an innovative evolution, Aqua technology is now applied to complex shower systems, through an array of products that ranges from the two-way and three-way diverters to the one-way to five-way independent controls, for an autonomous and simple handling.

AQUA è una collezione di nuova generazione di termostatici ad alte prestazioni, che grazie a corpi incasso universali garantisce il perfetto controllo della temperatura e dei comandi doccia. Frutto di un'evoluzione innovativa, la tecnologia Aqua è ora al servizio di impianti doccia complessi, grazie a una gamma di prodotti che spazia da due deviatori, a due e a tre vie, fino ai comandi indipendenti da una a cinque vie, per una gestione autonoma e semplice.

AQUA est une collection de thermostatiques à haute performance de nouvelle génération qui, grâce à ses corps encastrés universels, assure un contrôle parfait de la température et des commandes douche. Fruit d'une évolution innovante, la technologie Aqua est à présent au service d'installations hydrauliques complexes, grâce à une gamme de produits allant de deux déviateurs, bidirectionnel et tridirectionnel, jusqu'aux commandes indépendants d'un à cinq voies, pour une gestion autonome et simple.



LEAD FREE



ZINC FREE





Features.

Caratteristiche.
Caractéristiques.

1 HIGH FLOW

High flow 3/4" thermostatic cartridge.
Flow rate: 45 liters per minute at 3 bars.

ALTA PORTATA

Cartuccia termostatica 3-4" ad alta portata.
Velocità del flusso: 45 litri al minuto a 3 bar.

HAUT DÉBIT

Cartouche thermostatique 3-4" à débit élevé.
Vitesse du débit: 45 litres par minute à 3 bars.

3 REVERSIBLE

Reversible service check valves with filters and improved stop mechanism.

REVERSIBILE

Valvole di ritegno reversibili con filtri e meccanismo di bloccaggio ottimizzati.

RÉVERSIBLE

Clapets de retenue réversibles avec filtres et mécanisme de blocage perfectionné.

5 SHUTOFF VALVE

Shut-off valve outlets: connections right, left or both sides simultaneously.

VALVOLA DI ARRESTO

Prese della valvola di arresto: attacco a destra, sinistra o sui due lati contemporaneamente.

VANNE D'ARRÊT

Prises de la vanne d'arrêt: à droite, à gauche ou des deux côtés simultanément.

2 UNIVERSAL

Universal inlets for 1/2" and 3/4" connections (built-in adaptors: female threads for 1/2" connections and male threads for 3/4")

UNIVERSALE

Prese universali per attacchi da 1-2" e 3-4" (adattatori a incasso: connettore femmina per attacchi da 1-2" e maschio per 3-4").

UNIVERSEL

Prises universelles pour connexions de 1-2" et 3-4" (adaptateurs encastrés: connecteur femelle de 1-2" et connecteur mâle de 3-4")

4 FINISHES

European made nickel plated solid brass rough and cartridges

FINITURE

Cartucce in ottone massiccio grezzo nichelato di fabbricazione Europea.

FINITIONS

Cartouches en laiton nickelé brut fabriquées en Europe.

6 REMOVABLE

Removable plug at the top for an extra independent shut-off valve connection.

RIMOVIBILE

Spina rimovibile nella parte superiore, per un attacco della valvola di arresto ultra indipendente.

AMOVIBLE

Fiche amovibile dans la partie supérieure, pour une jonction extra indépendant de la vanne d'arrêt.







One solution for every shower.

Una soluzione per ogni doccia.
 Une solution pour chaque douche.



Thermostatic valve
1 WAY FREE

Valvola
 termostatica con 1
 via indipendente

Valve
 thermostatique par
 1 voie d'arrêt



Thermostatic valve
2 WAYS FREE

Valvola
 termostatica con 2
 vie indipendenti

Valve
 thermostatique par
 2 voies d'arrêt



Thermostatic valve
3 WAYS FREE

Valvola
 termostatica con 3
 vie indipendenti

Valve
 thermostatique par
 3 voies d'arrêt



Thermostatic valve
4 WAYS FREE

Valvola
 termostatica con 4
 vie indipendenti

Valve
 thermostatique par
 4 voies d'arrêt



Thermostatic valve
5 WAYS FREE

Valvola
 termostatica con 5
 vie indipendenti

Valve
 thermostatique par
 5 voies d'arrêt



Thermostatic valve
2 WAYS DIVERTER

Valvola
 termostatica con 2
 vie deviate

Valve
 thermostatique à 2
 voies déviées



Thermostatic valve
3 WAYS DIVERTER

Valvola
 termostatica con 3
 vie deviate

Valve
 thermostatique à 3
 voies déviées

POSSIBLE FUNCTIONS | POSSIBILI FUNZIONI | FONCTIONS POSSIBLES

| | | | | | | |
|--|--|--|--|--|--|--|
| | | | | | | |
| | | | | | | |
| | | | | | | |
| | | | | | | |
| | | | | | | |

Aqua

Thermostatic valve

**1
WAY
FREE**

RECESSED BODY PRICE
PREZZO CORPO INCASSO
PRIX PARTIE ENCASTRÉ

IUA100CCXN_1 8,6

PLATE AND HANDLES TRIMKIT
KIT PIASTRA E MANIGLIE
KIT PLAQUE ET POIGNÉE

EUA111CCNHJ 17,4

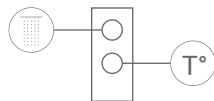

Thermostatic valve

**2
WAYS
FREE**

RECESSED BODY PRICE
PREZZO CORPO INCASSO
PRIX PARTIE ENCASTRÉ

IUA200CCXN_1 9,5

PLATE AND HANDLES TRIMKIT
KIT PIASTRA E MANIGLIE
KIT PLAQUE ET POIGNÉE

EUA222CCNMR2 26,8

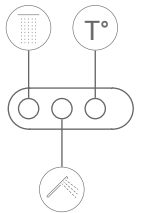

Thermostatic valve

**3
WAYS
FREE**

RECESSED BODY PRICE
PREZZO CORPO INCASSO
PRIX PARTIE ENCASTRÉ

IUA300CCXN_1 10,3

PLATE AND HANDLES TRIMKIT
KIT PIASTRA E MANIGLIE
KIT PLAQUE ET POIGNÉE

EUA312CCNKU 26,3

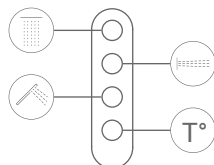

Thermostatic valve

**4
WAYS
FREE**

RECESSED BODY PRICE
PREZZO CORPO INCASSO
PRIX PARTIE ENCASTRÉ

IUA400CCXN_1 12,4

PLATE AND HANDLES TRIMKIT
KIT PIASTRA E MANIGLIE
KIT PLAQUE ET POIGNÉE

EUA421CCNID1 32,1

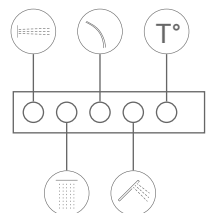

Thermostatic valve

5
WAYS
FREE

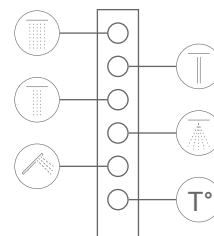

RECESSED BODY PRICE
PREZZO CORPO INCASSO
PRIX PARTIE ENCASTRÉ

IUA500CCXN_1 14,0

PLATE AND HANDLES TRIMKIT
KIT PIASTRA E MANIGLIE
KIT PLAQUE ET POIGNÉE

EUA511CCNHJ 37,4

Thermostatic valve

2
WAYS
DIVERTER

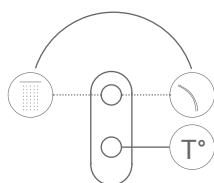

RECESSED BODY PRICE
PREZZO CORPO INCASSO
PRIX PARTIE ENCASTRÉ

IUA002CCXN_1 8,8

PLATE AND HANDLES TRIMKIT
KIT PIASTRA E MANIGLIE
KIT PLAQUE ET POIGNÉE

EUA612CCNKU 17,4

Thermostatic valve

3
WAYS
DIVERTER

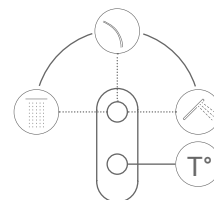

RECESSED BODY PRICE
PREZZO CORPO INCASSO
PRIX PARTIE ENCASTRÉ

IUA003CCXN_1 9,4

PLATE AND HANDLES TRIMKIT
KIT PIASTRA E MANIGLIE
KIT PLAQUE ET POIGNÉE

EUA712CCNKU 17,4

Aqua

Aesthetics.

Estetica.
Esthétique

The eclectic AQUA collection also offers twelve different types of handles and three different plates, which can be installed vertically or horizontally to satisfy all tastes and adapt to all environments.

La versatile collezione Aqua dispone inoltre di dodici diverse tipologie di maniglia e di tre diverse piastre, installabili in posizione verticale o orizzontale, per soddisfare tutti i gusti e adattarsi a tutti gli ambienti.
De plus, la collection universelle Aqua dispose de douze types de poignées et trois PLAQUEEs différentes, qui peuvent être installés en position verticale ou horizontale, pour satisfaire tous les goûts et s'adapter à tous les milieux.



Love Me



Belmondo



Bold



Hermes



Kusasi



Rubacuori



Wow



Hey Joe



Batlò



Marmo Black
Marquina



Marmo White
Carrara



Industria



Birkin



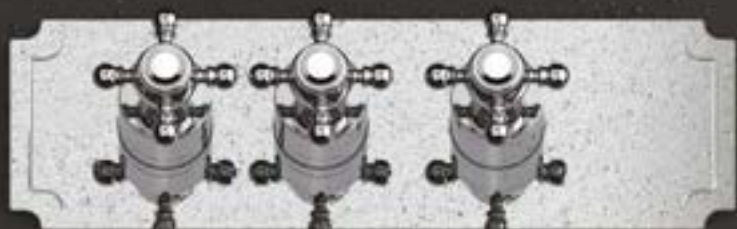

AQUA

Thermostatic 1 way

Termostatico 1 via
Thermostatique 1 voie

ARTICLE | ARTICOLO | ARTICLE

IUA100CCXN_1

Only the built-in 1\2" thermostatic unit of compact size, horizontal / vertical installation
Solo parte incasso termostatico 1/2 " ingombro ridotto, installazione orizzontale / verticale.
Seulement partie encastré du thermostatique 1/2" économie d'espace, installation horizontale / vertical.

CODE / COEFFICIENT | CODICE / COEFFICIENTE | CODE / COEFFICIENT

8,6

TECHNICAL DATA

Minimum dynamic pressure 0,5 bar
Maximum operational pressure 5 bar
Recommended operational pressure da 1 a 5 bar
Maximum hot water temperature 80°C

GENERAL FEATURES

Installation depth from 80 mm to 90 mm.
The intakes are fitted with G1/2" female G3/4" Male threaded connection, the outlets only G1/2"F (1, 2 or 3 way).
The temperature regulator lever is pre-set at 38°C.
Use of a pressure reducer is recommended if pressures in the system exceed 5 bar.

DATI TECNICI

Pressione dinamica minima 0,5 bar
Pressione di esercizio massima 5 bar
Pressione di utilizzo raccomandata da 1 a 5 bar
Temperatura massima acqua calda 80°C

CARATTERISTICHE GENERALI

Profondità di installazione da 80 mm a 90 mm.
Le entrate vengono fornite con filetto G1/2" femmina G3/4" maschio, le uscite solo G1/2"F (1, 2 o 3 vie).
La maniglia di regolazione temperatura, viene pre-settata a 38°C.
Si raccomanda l'utilizzo di un riduttore di pressione, se all'interno dell'impianto, si hanno pressioni superiori a 5 bar.

DONNÉES TECHNIQUES

Pression dynamique minimum 0,5 bar
Pression de service maximale de 5 bar
Pression d'utilisation conseillé de 1 à 5 bar
Température maximale de l'eau chaude 80 ° C

CARACTERISTIQUES GENERALES

Profondeur de montage de 80 mm à 90 mm.
Les entrées sont fournis avec filetage G1/2" femelle G3/4" mâle, les sorties G1/2"F (1,2,ou 3 voies).
La poignée de réglage de la température, est pré-réglée à 38 ° C Si à l'intérieur du système vous avez des pressions supérieures à 5 bars, il est recommandé l'utilisation d'un réducteur de pression..

Built-in part - Parte incasso - Corps encastré

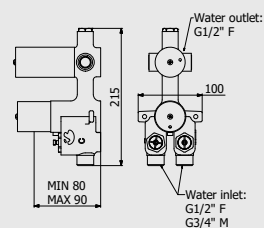

Plate and handles - Parte esterna - Plaque et poignée

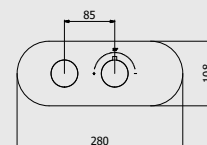
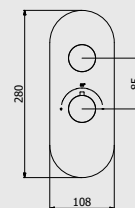

Plate and handles - Parte esterna - Plaque et poignée



PACKAGING

L: 240 mm D: 115 mm H: 160 mm 3,4 kg

ORIENTATION | ORIENTAZIONE | ORIENTATION

2 ways to Installation: horizontal or vertical
2 modalità di installazione: verticale o orizzontale
2 modalités de installation: vertical ou horizontal .

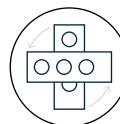

FOR ALL MODELS
PER TUTTI I MODELLI
POUR TOUS LES MODÈLES



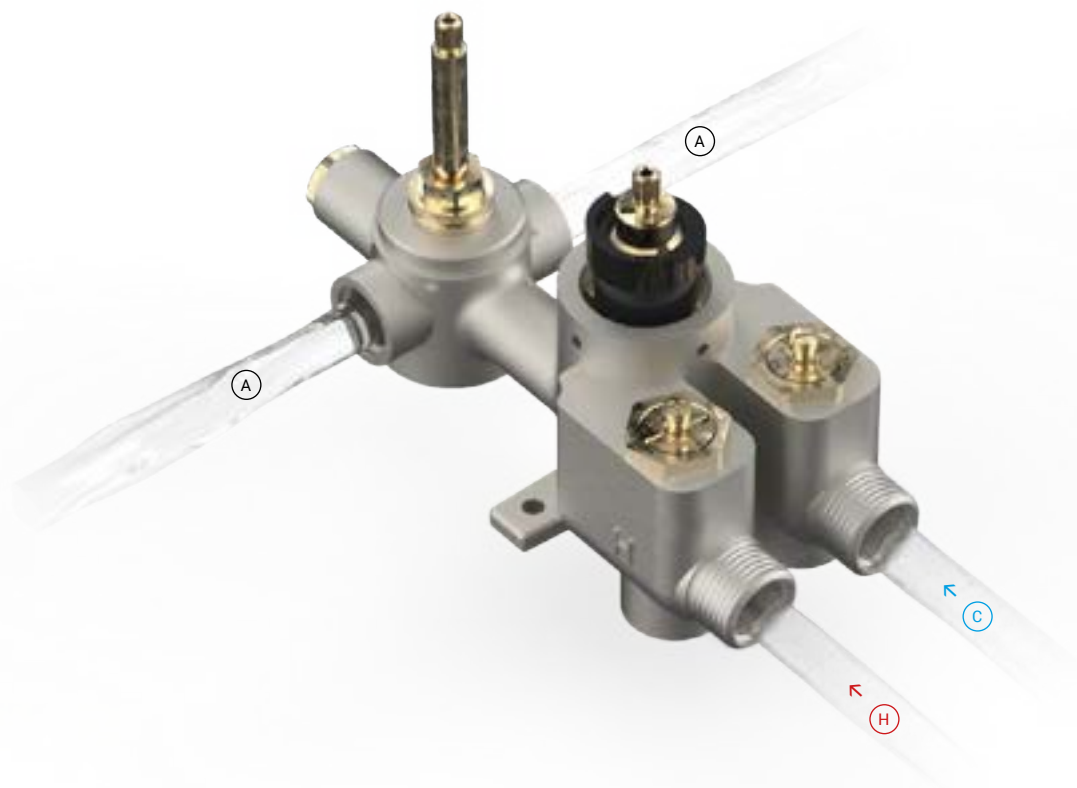

A Mixed water outlet
Uscita acqua miscelata
Sortie eau mélangé



H Hot water
Acqua calda
Eau chaude



C Cold water
Acqua fredda
Eau froide

Aqua

PORTATE | WATER FLOW | DÉBIT D'EAU

| 0.2 BAR | 0.5 BAR | 1 BAR | 2 BAR | 3 BAR | 4 BAR | 5 BAR |
|----------|---------|--------|--------|--------|--------|--------|
| 10,7 l/m | 18 l/m | 26 l/m | 37 l/m | 45 l/m | 51 l/m | 56 l/m |

Hey Joe!



RECESSED BODY
CORPO INCASSO
PARTIE ENCASTRÉ
IUA100CCXN_1 8,6

PACKAGING

L: 530 mm
D: 145 mm
H: 90 mm

4,16 kg



VERTICAL | VERTICALE | VERTICAL

| PLATE AND HANDLES TRIMKIT KIT PIASTRA E MANIGLIE KIT PLAQUE ET POIGNÉE | | |
|--|-------------|------|
| CC | EUA112CCNHJ | 17,3 |
| SS | EUA112SSNHJ | 21,6 |
| BO | EUA112BONHJ | 20,8 |
| NP | EUA112NPNHJ | 20,8 |
| CF | EUA112CFNHJ | 26,0 |
| CS | EUA112CSNHJ | 27,7 |
| OO | EUA112OONHJ | 26,0 |
| II | EUA112IINHJ | 26,0 |
| IS | EUA112ISNHJ | 27,7 |
| RS | EUA112RSNHJ | 26,0 |
| SR | EUA112SRNHJ | 27,7 |
| OS | EUA112OSNHJ | 27,7 |

HORIZONTAL | ORIZZONTALE | HORIZONTAL

| PLATE AND HANDLES TRIMKIT KIT PIASTRA E MANIGLIE KIT PLAQUE ET POIGNÉE | | |
|--|-------------|------|
| CC | EUA122CCNHJ | 17,3 |
| SS | EUA122SSNHJ | 21,6 |
| BO | EUA122BONHJ | 20,8 |
| NP | EUA122NPNHJ | 20,8 |
| CF | EUA122CFNHJ | 26,0 |
| CS | EUA122CSNHJ | 27,7 |
| OO | EUA122OONHJ | 26,0 |
| II | EUA122IINHJ | 26,0 |
| IS | EUA122ISNHJ | 27,7 |
| RS | EUA122RSNHJ | 26,0 |
| SR | EUA122SRNHJ | 27,7 |
| OS | EUA122OSNHJ | 27,7 |

Loveme



RECESSED BODY
CORPO INCASSO
PARTIE ENCASTRÉ
IUA100CCXN_1 8,6

PACKAGING

L: 530 mm
D: 145 mm
H: 90 mm

4,16 kg



VERTICAL | VERTICALE | VERTICAL

| PLATE AND HANDLES TRIMKIT KIT PIASTRA E MANIGLIE KIT PLAQUE ET POIGNÉE | | |
|--|-------------|------|
| CC | EUA112CCNLM | 17,3 |
| SS | EUA112SSNLM | 21,6 |
| BO | EUA112BONLM | 20,8 |
| NP | EUA112NPNLM | 20,8 |
| CS | EUA112CSNLM | 27,7 |
| IS | EUA112ISNLM | 27,7 |
| SR | EUA112SRNLM | 27,7 |
| OS | EUA112OSNLM | 27,7 |
| ON | EUA112ONNLM | 17,3 |

HORIZONTAL | ORIZZONTALE | HORIZONTAL

| PLATE AND HANDLES TRIMKIT KIT PIASTRA E MANIGLIE KIT PLAQUE ET POIGNÉE | | |
|--|-------------|------|
| CC | EUA122CCNLM | 17,3 |
| SS | EUA122SSNLM | 21,6 |
| BO | EUA122BONLM | 20,8 |
| NP | EUA122NPNLM | 20,8 |
| CS | EUA122CSNLM | 27,7 |
| IS | EUA122ISNLM | 27,7 |
| SR | EUA122SRNLM | 27,7 |
| OS | EUA122OSNLM | 27,7 |
| ON | EUA122ONNLM | 17,3 |

Belmondo



RECESSED BODY
CORPO INCASSO
PARTIE ENCASTRÉ
IUA100CCXN_1 8,6

PACKAGING

L: 530 mm
D: 145 mm
H: 90 mm

4,16 kg



VERTICAL | VERTICALE | VERTICAL

| PLATE AND HANDLES TRIMKIT KIT PIASTRA E MANIGLIE KIT PLAQUE ET POIGNÉE | | |
|--|-------------|------|
| CC | EUA112CCNBT | 17,3 |
| OO | EUA112OONBT | 26,0 |
| II | EUA112IINBT | 26,0 |
| RS | EUA112RSNBT | 26,0 |
| PL | EUA112PLNBT | 27,7 |

HORIZONTAL | ORIZZONTALE | HORIZONTAL

| PLATE AND HANDLES TRIMKIT KIT PIASTRA E MANIGLIE KIT PLAQUE ET POIGNÉE | | |
|--|-------------|------|
| CC | EUA122CCNBT | 17,3 |
| OO | EUA122OONBT | 26,0 |
| II | EUA122IINBT | 26,0 |
| RS | EUA122RSNBT | 26,0 |
| PL | EUA122PLNBT | 27,7 |

Batlò



RECESSED BODY
CORPO INCASSO
PARTIE ENCASTRÉ
IUA100CCXN_1 8,6

PACKAGING

L: 530 mm
D: 145 mm
H: 90 mm

4,16 kg



VERTICAL | VERTICALE | VERTICAL

| PLATE AND HANDLES TRIMKIT KIT PIASTRA E MANIGLIE KIT PLAQUE ET POIGNÉE | | |
|--|-------------|------|
| CC | EUA112CCNBI | 17,3 |
| SS | EUA112SSNBI | 21,6 |
| BO | EUA112BONBI | 20,8 |
| NP | EUA112NPNBI | 20,8 |
| CF | EUA112CFNBI | 26,0 |
| CS | EUA112CSNBI | 27,7 |
| OO | EUA112OONBI | 26,0 |
| II | EUA112IINBI | 26,0 |
| IS | EUA112ISNBI | 27,7 |
| RS | EUA112RSNBI | 26,0 |
| SR | EUA112SRNBI | 27,7 |
| OS | EUA112OSNBI | 27,7 |

HORIZONTAL | ORIZZONTALE | HORIZONTAL

| PLATE AND HANDLES TRIMKIT KIT PIASTRA E MANIGLIE KIT PLAQUE ET POIGNÉE | | |
|--|-------------|------|
| CC | EUA122CCNBI | 17,3 |
| SS | EUA122SSNBI | 21,6 |
| BO | EUA122BONBI | 20,8 |
| NP | EUA122NPNBI | 20,8 |
| CF | EUA122CFNBI | 26,0 |
| CS | EUA122CSNBI | 27,7 |
| OO | EUA122OONBI | 26,0 |
| II | EUA122IINBI | 26,0 |
| IS | EUA122ISNBI | 27,7 |
| RS | EUA122RSNBI | 26,0 |
| SR | EUA122SRNBI | 27,7 |
| OS | EUA122OSNBI | 27,7 |

Kusasi



RECESSED BODY
CORPO INCASSO
PARTIE ENCASTRÉ
IUA100CCXN_1 8,6

PACKAGING

L: 530 mm
D: 145 mm
H: 90 mm

4,16 kg



VERTICAL | VERTICALE | VERTICAL

| PLATE AND HANDLES TRIMKIT KIT PIASTRA E MANIGLIE KIT PLAQUE ET POIGNÉE | | |
|--|-------------|------|
| CC | EUA112CCNKU | 17,3 |
| SS | EUA112SSNKU | 21,6 |
| NP | EUA112NPNKU | 20,8 |

HORIZONTAL | ORIZZONTALE | HORIZONTAL

| PLATE AND HANDLES TRIMKIT KIT PIASTRA E MANIGLIE KIT PLAQUE ET POIGNÉE | | |
|--|-------------|------|
| CC | EUA122CCNKU | 17,3 |
| SS | EUA122SSNKU | 21,6 |
| NP | EUA122NPNKU | 20,8 |

Wow



RECESSED BODY
CORPO INCASSO
PARTIE ENCASTRÉ
IUA100CCXN_1 8,6

PACKAGING

L: 530 mm
D: 145 mm
H: 90 mm

4,16 kg

VERTICAL | VERTICALE | VERTICAL

PLATE AND HANDLES TRIMKIT
KIT PIASTRA E MANIGLIE
KIT PLAQUE ET POIGNÉE

| | | |
|----|-------------|------|
| CC | EUA112CCNWO | 17,3 |
| SS | EUA112SSNWO | 21,6 |
| BO | EUA112BONWO | 20,8 |
| NP | EUA112NPNWO | 20,8 |
| OO | EUA112OONWO | 26,0 |

HORIZONTAL | ORIZZONTALE | HORIZONTAL

PLATE AND HANDLES TRIMKIT
KIT PIASTRA E MANIGLIE
KIT PLAQUE ET POIGNÉE

| | | |
|----|-------------|------|
| CC | EUA122CCNWO | 17,3 |
| SS | EUA122SSNWO | 21,6 |
| BO | EUA122BONWO | 20,8 |
| NP | EUA122NPNWO | 20,8 |
| OO | EUA122OONWO | 26,0 |

Industria



RECESSED BODY
CORPO INCASSO
PARTIE ENCASTRÉ
IUA100CCXN_1 8,6

PACKAGING

L: 530 mm
D: 145 mm
H: 90 mm

4,16 kg

VERTICAL | VERTICALE | VERTICAL

PLATE AND HANDLES TRIMKIT
KIT PIASTRA E MANIGLIE
KIT PLAQUE ET POIGNÉE

| | | |
|----|--------------|------|
| CC | EUA112CCNID1 | 17,3 |
| SS | EUA112SSNID1 | 21,6 |
| NP | EUA112NPNID1 | 20,8 |
| CF | EUA112CFNID1 | 26,0 |
| CS | EUA112CSNID1 | 27,7 |
| OO | EUA112OONID1 | 26,0 |
| II | EUA112IINID1 | 26,0 |
| IS | EUA112ISNID1 | 27,7 |
| RS | EUA112RSNID1 | 26,0 |
| SR | EUA112SRNID1 | 27,7 |
| OS | EUA112OSNID1 | 27,7 |
| ON | EUA112ONNID1 | 17,3 |

HORIZONTAL | ORIZZONTALE | HORIZONTAL

PLATE AND HANDLES TRIMKIT
KIT PIASTRA E MANIGLIE
KIT PLAQUE ET POIGNÉE

| | | |
|----|--------------|------|
| CC | EUA122CCNID1 | 17,3 |
| SS | EUA122SSNID1 | 21,6 |
| NP | EUA122NPNID1 | 20,8 |
| CF | EUA122CFNID1 | 26,0 |
| CS | EUA122CSNID1 | 27,7 |
| OO | EUA122OONID1 | 26,0 |
| II | EUA122IINID1 | 26,0 |
| IS | EUA122ISNID1 | 27,7 |
| RS | EUA122RSNID1 | 26,0 |
| SR | EUA122SRNID1 | 27,7 |
| OS | EUA122OSNID1 | 27,7 |
| ON | EUA122ONNID1 | 17,3 |

Bold



RECESSED BODY
CORPO INCASSO
PARTIE ENCASTRÉ
IUA100CCXN_1 8,6

PACKAGING

L: 530 mm
D: 145 mm
H: 90 mm

4,16 kg

VERTICAL | VERTICALE | VERTICAL

PLATE AND HANDLES TRIMKIT
KIT PIASTRA E MANIGLIE
KIT PLAQUE ET POIGNÉE

| | | |
|----|-------------|------|
| CC | EUA112CCNB1 | 18,3 |
| SS | EUA112SSNB1 | 22,9 |
| NP | EUA112NPNB1 | 22,0 |
| CF | EUA112CFNB1 | 27,5 |
| CS | EUA112CSNB1 | 29,3 |
| OO | EUA112OONB1 | 27,5 |
| II | EUA112IINB1 | 27,5 |
| IS | EUA112ISNB1 | 29,3 |
| RS | EUA112RSNB1 | 27,5 |
| SR | EUA112SRNB1 | 29,3 |
| OS | EUA112OSNB1 | 29,3 |
| ON | EUA112ONNB1 | 18,3 |

HORIZONTAL | ORIZZONTALE | HORIZONTAL

PLATE AND HANDLES TRIMKIT
KIT PIASTRA E MANIGLIE
KIT PLAQUE ET POIGNÉE

| | | |
|----|-------------|------|
| CC | EUA122CCNB1 | 18,3 |
| SS | EUA122SSNB1 | 22,9 |
| NP | EUA122NPNB1 | 22,0 |
| CF | EUA122CFNB1 | 27,5 |
| CS | EUA122CSNB1 | 29,3 |
| OO | EUA122OONB1 | 27,5 |
| II | EUA122IINB1 | 27,5 |
| IS | EUA122ISNB1 | 29,3 |
| RS | EUA122RSNB1 | 27,5 |
| SR | EUA122SRNB1 | 29,3 |
| OS | EUA122OSNB1 | 29,3 |
| ON | EUA122ONNB1 | 18,3 |

Birkin



RECESSED BODY
CORPO INCASSO
PARTIE ENCASTRÉ
IUA100CCXN_1 8,6

PACKAGING

L: 530 mm
D: 145 mm
H: 90 mm

4,16 kg

VERTICAL | VERTICALE | VERTICAL

PLATE AND HANDLES TRIMKIT
KIT PIASTRA E MANIGLIE
KIT PLAQUE ET POIGNÉE

| | | |
|----|--------------|------|
| CC | EUA112CCNBR3 | 22,3 |
| SS | EUA112SSNBR3 | 27,9 |
| RS | EUA112RSNBR3 | 33,5 |
| OS | EUA112OSNBR3 | 35,7 |
| PL | EUA112PLNBR3 | 35,7 |

HORIZONTAL | ORIZZONTALE | HORIZONTAL

PLATE AND HANDLES TRIMKIT
KIT PIASTRA E MANIGLIE
KIT PLAQUE ET POIGNÉE

| | | |
|----|--------------|------|
| CC | EUA122CCNBR3 | 22,3 |
| SS | EUA122SSNBR3 | 27,9 |
| RS | EUA122RSNBR3 | 33,5 |
| OS | EUA122OSNBR3 | 35,7 |
| PL | EUA122PLNBR3 | 35,7 |

Marmo



RECESSED BODY
CORPO INCASSO
PARTIE ENCASTRÉ
IUA100CCXN_1 8,6

PACKAGING

L: 530 mm
D: 145 mm
H: 90 mm

4,24 kg

MARBLE

White Carrara

Black Marquina

VERTICAL | VERTICALE | VERTICAL

PLATE AND HANDLES TRIMKIT
KIT PIASTRA E MANIGLIE
KIT PLAQUE ET POIGNÉE

| | | | |
|----|--------------|--------------|------|
| CC | EUA112CCNMR1 | EUA112CCNMR2 | 20,7 |
| SS | EUA112SSNMR1 | EUA112SSNMR2 | 25,9 |
| BO | EUA112BONMR1 | EUA112BONMR2 | 24,9 |
| NP | EUA112NPNMR1 | EUA112NPNMR2 | 24,9 |
| CF | EUA112CFNMR1 | EUA112CFNMR2 | 31,1 |
| CS | EUA112CSNMR1 | EUA112CSNMR2 | 33,2 |
| OO | EUA112OONMR1 | EUA112OONMR2 | 31,1 |
| II | EUA112IINMR1 | EUA112IINMR2 | 31,1 |
| IS | EUA112ISNMR1 | EUA112ISNMR2 | 33,2 |
| RS | EUA112RSNMR1 | EUA112RSNMR2 | 31,1 |
| SR | EUA112SRNMR1 | EUA112SRNMR2 | 33,2 |
| OS | EUA112OSNMR1 | EUA112OSNMR2 | 33,2 |
| ON | EUA112ONNMR1 | EUA112PLNMR2 | 20,7 |
| PL | EUA112PLNMR1 | EUA112PLNMR2 | 33,2 |

HORIZONTAL | ORIZZONTALE | HORIZONTAL

PLATE AND HANDLES TRIMKIT
KIT PIASTRA E MANIGLIE
KIT PLAQUE ET POIGNÉE

| | | | |
|----|--------------|--------------|------|
| CC | EUA122CCNMR1 | EUA122CCNMR2 | 20,7 |
| SS | EUA122SSNMR1 | EUA122SSNMR2 | 25,9 |
| BO | EUA122BONMR1 | EUA122BONMR2 | 24,9 |
| NP | EUA122NPNMR1 | EUA122NPNMR2 | 24,9 |
| CF | EUA122CFNMR1 | EUA122CFNMR2 | 31,1 |
| CS | EUA122CSNMR1 | EUA122CSNMR2 | 33,2 |
| OO | EUA122OONMR1 | EUA122OONMR2 | 31,1 |
| II | EUA122IINMR1 | EUA122IINMR2 | 31,1 |
| IS | EUA122ISNMR1 | EUA122ISNMR2 | 33,2 |
| RS | EUA122RSNMR1 | EUA122RSNMR2 | 31,1 |
| SR | EUA122SRNMR1 | EUA122SRNMR2 | 33,2 |
| OS | EUA122OSNMR1 | EUA122OSNMR2 | 33,2 |
| ON | EUA122ONNMR1 | EUA122PLNMR2 | 20,7 |
| PL | EUA122PLNMR1 | EUA122PLNMR2 | 33,2 |

Aqua

Rubacuori



RECESSED BODY
CORPO INCASSO
PARTIE ENCASTRÉ
IUA100CCXN_1 8,6

PACKAGING

L: 530 mm
D: 145 mm
H: 90 mm

4,16 kg



VERTICAL | VERTICALE | VERTICAL

PLATE AND HANDLES TRIMKIT
KIT PIASTRA E MANIGLIE
KIT PLAQUE ET POIGNÉE

| | | |
|----|-------------|------|
| CC | EUA111CCNRU | 17,3 |
| SS | EUA111SSNRU | 21,6 |
| BO | EUA111BONRU | 20,8 |
| NP | EUA111NPNRU | 20,8 |
| CF | EUA111CFNRU | 26,0 |
| CS | EUA111CSNRU | 27,7 |
| OO | EUA111OONRU | 26,0 |
| II | EUA111IINRU | 26,0 |
| IS | EUA111ISNRU | 27,7 |
| RS | EUA111RSNRU | 26,0 |
| SR | EUA111SRNRU | 27,7 |
| OS | EUA111OSNRU | 27,7 |

HORIZONTAL | ORIZZONTALE | HORIZONTAL

PLATE AND HANDLES TRIMKIT
KIT PIASTRA E MANIGLIE
KIT PLAQUE ET POIGNÉE

| | | |
|----|-------------|------|
| CC | EUA121CCNRU | 17,3 |
| SS | EUA121SSNRU | 21,6 |
| BO | EUA121BONRU | 20,8 |
| NP | EUA121NPNRU | 20,8 |
| CF | EUA121CFNRU | 26,0 |
| CS | EUA121CSNRU | 27,7 |
| OO | EUA121OONRU | 26,0 |
| II | EUA121IINRU | 26,0 |
| IS | EUA121ISNRU | 27,7 |
| RS | EUA121RSNRU | 26,0 |
| SR | EUA121SRNRU | 27,7 |
| OS | EUA121OSNRU | 27,7 |

Hey joe!



RECESSED BODY
CORPO INCASSO
PARTIE ENCASTRÉ
IUA100CCXN_1 8,6

PACKAGING

L: 530 mm
D: 145 mm
H: 90 mm

4,16 kg



VERTICAL | VERTICALE | VERTICAL

PLATE AND HANDLES TRIMKIT
KIT PIASTRA E MANIGLIE
KIT PLAQUE ET POIGNÉE

| | | |
|----|-------------|------|
| CC | EUA111CCNRU | 17,3 |
| SS | EUA111SSNRU | 21,6 |
| BO | EUA111BONRU | 20,8 |
| NP | EUA111NPNRU | 20,8 |
| CF | EUA111CFNRU | 26,0 |
| CS | EUA111CSNRU | 27,7 |
| OO | EUA111OONRU | 26,0 |
| II | EUA111IINRU | 26,0 |
| IS | EUA111ISNRU | 27,7 |
| RS | EUA111RSNRU | 26,0 |
| SR | EUA111SRNRU | 27,7 |
| OS | EUA111OSNRU | 27,7 |

HORIZONTAL | ORIZZONTALE | HORIZONTAL

PLATE AND HANDLES TRIMKIT
KIT PIASTRA E MANIGLIE
KIT PLAQUE ET POIGNÉE

| | | |
|----|-------------|------|
| CC | EUA121CCNRU | 17,3 |
| SS | EUA121SSNRU | 21,6 |
| BO | EUA121BONRU | 20,8 |
| NP | EUA121NPNRU | 20,8 |
| CF | EUA121CFNRU | 26,0 |
| CS | EUA121CSNRU | 27,7 |
| OO | EUA121OONRU | 26,0 |
| II | EUA121IINRU | 26,0 |
| IS | EUA121ISNRU | 27,7 |
| RS | EUA121RSNRU | 26,0 |
| SR | EUA121SRNRU | 27,7 |
| OS | EUA121OSNRU | 27,7 |

Belmondo



RECESSED BODY
CORPO INCASSO
PARTIE ENCASTRÉ
IUA100CCXN_1 8,6

PACKAGING

L: 530 mm
D: 145 mm
H: 90 mm

4,16 kg



VERTICAL | VERTICALE | VERTICAL

PLATE AND HANDLES TRIMKIT
KIT PIASTRA E MANIGLIE
KIT PLAQUE ET POIGNÉE

| | | |
|----|-------------|------|
| CC | EUA111CCNBT | 17,3 |
| OO | EUA111OONBT | 26,0 |
| II | EUA111IINBT | 26,0 |
| RS | EUA111RSNBT | 26,0 |
| PL | EUA111PLNBT | 27,7 |

HORIZONTAL | ORIZZONTALE | HORIZONTAL

PLATE AND HANDLES TRIMKIT
KIT PIASTRA E MANIGLIE
KIT PLAQUE ET POIGNÉE

| | | |
|----|-------------|------|
| CC | EUA121CCNBT | 17,3 |
| OO | EUA121OONBT | 26,0 |
| II | EUA121IINBT | 26,0 |
| RS | EUA121RSNBT | 26,0 |
| PL | EUA121PLNBT | 27,7 |

Kusasi



RECESSED BODY
CORPO INCASSO
PARTIE ENCASTRÉ
IUA100CCXN_1 8,6

PACKAGING

L: 530 mm
D: 145 mm
H: 90 mm

4,16 kg



VERTICAL | VERTICALE | VERTICAL

PLATE AND HANDLES TRIMKIT
KIT PIASTRA E MANIGLIE
KIT PLAQUE ET POIGNÉE

| | | |
|----|-------------|------|
| CC | EUA111CCNKU | 17,3 |
| SS | EUA111SSNKU | 21,6 |
| NP | EUA111NPNKU | 20,8 |

HORIZONTAL | ORIZZONTALE | HORIZONTAL

PLATE AND HANDLES TRIMKIT
KIT PIASTRA E MANIGLIE
KIT PLAQUE ET POIGNÉE

| | | |
|----|-------------|------|
| CC | EUA121CCNKU | 17,3 |
| SS | EUA121SSNKU | 21,6 |
| NP | EUA121NPNKU | 20,8 |

Wow



RECESSED BODY
CORPO INCASSO
PARTIE ENCASTRÉ
IUA100CCXN_1 8,6

PACKAGING

L: 530 mm
D: 145 mm
H: 90 mm

4,16 kg



VERTICAL | VERTICALE | VERTICAL

PLATE AND HANDLES TRIMKIT
KIT PIASTRA E MANIGLIE
KIT PLAQUE ET POIGNÉE

| | | |
|----|-------------|------|
| CC | EUA111CCNWO | 17,3 |
| SS | EUA111SSNWO | 21,6 |
| BO | EUA111BONWO | 20,8 |
| NP | EUA111NPNWO | 20,8 |
| OO | EUA111OONWO | 26,0 |

HORIZONTAL | ORIZZONTALE | HORIZONTAL

PLATE AND HANDLES TRIMKIT
KIT PIASTRA E MANIGLIE
KIT PLAQUE ET POIGNÉE

| | | |
|----|-------------|------|
| CC | EUA121CCNWO | 17,3 |
| SS | EUA121SSNWO | 21,6 |
| BO | EUA121BONWO | 20,8 |
| NP | EUA121NPNWO | 20,8 |
| OO | EUA121OONWO | 26,0 |

Industria



RECESSED BODY
CORPO INCASSO
PARTIE ENCASTRÉ
IUA100CCXN_1 8,6

PACKAGING
L: 530 mm
D: 145 mm
H: 90 mm
4,16 kg

VERTICAL | VERTICALE | VERTICAL

PLATE AND HANDLES TRIMKIT
KIT PIASTRA E MANIGLIE
KIT PLAQUE ET POIGNÉE

| | | |
|----|--------------|------|
| CC | EUA111CCNID1 | 17,3 |
| SS | EUA111SSNID1 | 21,6 |
| NP | EUA111NPNID1 | 20,8 |
| CF | EUA111CFNID1 | 26,0 |
| CS | EUA111CSNID1 | 27,7 |
| OO | EUA111OONID1 | 26,0 |
| II | EUA111IINID1 | 26,0 |
| IS | EUA111ISNID1 | 27,7 |
| RS | EUA111RSNID1 | 26,0 |
| SR | EUA111SRNID1 | 27,7 |
| OS | EUA111OSNID1 | 27,7 |
| ON | EUA111ONNID1 | 17,3 |

HORIZONTAL | ORIZZONTALE | HORIZONTAL

PLATE AND HANDLES TRIMKIT
KIT PIASTRA E MANIGLIE
KIT PLAQUE ET POIGNÉE

| | | |
|----|--------------|------|
| CC | EUA121CCNID1 | 17,3 |
| SS | EUA121SSNID1 | 21,6 |
| NP | EUA121NPNID1 | 20,8 |
| CF | EUA121CFNID1 | 26,0 |
| CS | EUA121CSNID1 | 27,7 |
| OO | EUA121OONID1 | 26,0 |
| II | EUA121IINID1 | 26,0 |
| IS | EUA121ISNID1 | 27,7 |
| RS | EUA121RSNID1 | 26,0 |
| SR | EUA121SRNID1 | 27,7 |
| OS | EUA121OSNID1 | 27,7 |
| ON | EUA121ONNID1 | 17,3 |

Marmo



RECESSED BODY
CORPO INCASSO
PARTIE ENCASTRÉ
IUA100CCXN_1 8,6

PACKAGING
L: 530 mm
D: 145 mm
H: 90 mm
4,24 kg

MARBLE
White Carrara
Black Marquina

VERTICAL | VERTICALE | VERTICAL

PLATE AND HANDLES TRIMKIT
KIT PIASTRA E MANIGLIE
KIT PLAQUE ET POIGNÉE

| | | | |
|----|--------------|--------------|------|
| CC | EUA111CCNMR1 | EUA111CCNMR2 | 20,7 |
| SS | EUA111SSNMR1 | EUA111SSNMR2 | 25,9 |
| BO | EUA111BONMR1 | EUA111BONMR2 | 24,9 |
| NP | EUA111NPNMR1 | EUA111NPNMR2 | 24,9 |
| CF | EUA111CFNMR1 | EUA111CFNMR2 | 31,1 |
| CS | EUA111CSNMR1 | EUA111CSNMR2 | 33,2 |
| OO | EUA111OONMR1 | EUA111OONMR2 | 31,1 |
| II | EUA111IINMR1 | EUA111IINMR2 | 31,1 |
| IS | EUA111ISNMR1 | EUA111ISNMR2 | 33,2 |
| RS | EUA111RSNMR1 | EUA111RSNMR2 | 31,1 |
| SR | EUA111SRNMR1 | EUA111SRNMR2 | 33,2 |
| OS | EUA111OSNMR1 | EUA111OSNMR2 | 33,2 |
| ON | EUA111ONNMR1 | EUA111PLNMR2 | 20,7 |
| PL | EUA111PLNMR1 | EUA111PLNMR2 | 33,2 |

HORIZONTAL | ORIZZONTALE | HORIZONTAL

PLATE AND HANDLES TRIMKIT
KIT PIASTRA E MANIGLIE
KIT PLAQUE ET POIGNÉE

| | | | |
|----|--------------|--------------|------|
| CC | EUA121CCNMR1 | EUA121CCNMR2 | 20,7 |
| SS | EUA121SSNMR1 | EUA121SSNMR2 | 25,9 |
| BO | EUA121BONMR1 | EUA121BONMR2 | 24,9 |
| NP | EUA121NPNMR1 | EUA121NPNMR2 | 24,9 |
| CF | EUA121CFNMR1 | EUA121CFNMR2 | 31,1 |
| CS | EUA121CSNMR1 | EUA121CSNMR2 | 33,2 |
| OO | EUA121OONMR1 | EUA121OONMR2 | 31,1 |
| II | EUA121IINMR1 | EUA121IINMR2 | 31,1 |
| IS | EUA121ISNMR1 | EUA121ISNMR2 | 33,2 |
| RS | EUA121RSNMR1 | EUA121RSNMR2 | 31,1 |
| SR | EUA121SRNMR1 | EUA121SRNMR2 | 33,2 |
| OS | EUA121OSNMR1 | EUA121OSNMR2 | 33,2 |
| ON | EUA121ONNMR1 | EUA121PLNMR2 | 20,7 |
| PL | EUA121PLNMR1 | EUA121PLNMR2 | 33,2 |

Hermes



RECESSED BODY
CORPO INCASSO
PARTIE ENCASTRÉ
IUA100CCXN_1 8,6

PACKAGING
L: 530 mm
D: 145 mm
H: 90 mm
4,16 kg

VERTICAL | VERTICALE | VERTICAL

PLATE AND HANDLES TRIMKIT
KIT PIASTRA E MANIGLIE
KIT PLAQUE ET POIGNÉE

| | | |
|----|-------------|------|
| CC | EUA115CCNHR | 17,4 |
| SS | EUA115SSNHR | 21,8 |
| II | EUA115IINHR | 26,1 |
| RS | EUA115RSNHR | 26,1 |
| OS | EUA115OSNHR | 27,9 |
| RR | EUA115RRNHR | 24,4 |
| BB | EUA115BBNHR | 24,4 |
| PL | EUA115PLNHR | 27,9 |

HORIZONTAL | ORIZZONTALE | HORIZONTAL

PLATE AND HANDLES TRIMKIT
KIT PIASTRA E MANIGLIE
KIT PLAQUE ET POIGNÉE

| | | |
|----|-------------|------|
| CC | EUA125CCNHR | 17,4 |
| SS | EUA125SSNHR | 21,8 |
| II | EUA115IINHR | 26,1 |
| RS | EUA125RSNHR | 26,1 |
| OS | EUA125OSNHR | 27,9 |
| RR | EUA125RRNHR | 24,4 |
| BB | EUA125BBNHR | 24,4 |
| PL | EUA125PLNHR | 27,9 |

Birkin



RECESSED BODY
CORPO INCASSO
PARTIE ENCASTRÉ
IUA100CCXN_1 8,6

PACKAGING
L: 530 mm
D: 145 mm
H: 90 mm
4,16 kg

VERTICAL | VERTICALE | VERTICAL

PLATE AND HANDLES TRIMKIT
KIT PIASTRA E MANIGLIE
KIT PLAQUE ET POIGNÉE

| | | |
|----|--------------|------|
| CC | EUA115CCNBR3 | 22,3 |
| SS | EUA115SSNBR3 | 27,9 |
| RS | EUA115RSNBR3 | 33,5 |
| OS | EUA115OSNBR3 | 35,7 |
| PL | EUA115PLNBR3 | 35,7 |

HORIZONTAL | ORIZZONTALE | HORIZONTAL

PLATE AND HANDLES TRIMKIT
KIT PIASTRA E MANIGLIE
KIT PLAQUE ET POIGNÉE

| | | |
|----|--------------|------|
| CC | EUA125CCNBR3 | 22,3 |
| SS | EUA125SSNBR3 | 27,9 |
| RS | EUA125RSNBR3 | 33,5 |
| OS | EUA125OSNBR3 | 35,7 |
| PL | EUA125PLNBR3 | 35,7 |

Aqua

AQUA

Thermostatic 2 ways

Termostatico 2 vie
Thermostatique 2 voies

ARTICLE | ARTICOLO | ARTICLE

IUA200CCXN_1

Only the built-in 1\2" thermostatic unit of compact size, horizontal / vertical installation
Solo parte incasso termostatico 1/2 " ingombro ridotto, installazione orizzontale / verticale.
Seulement partie encastré du thermostatique 1/2" économie d'espace, installation horizontale / vertical.

CODE / COEFFICIENT | CODICE / COEFFICIENTE | CODE / COEFFICIENT

9,5

TECHNICAL DATA

Minimum dynamic pressure 0,5 bar
Maximum operational pressure 5 bar
Recommended operational pressure da 1 a 5 bar
Maximum hot water temperature 80°C

GENERAL FEATURES

Installation depth from 80 mm to 90 mm.
The intakes are fitted with G1/2" female G3/4" Male threaded connection, the outlets only G1/2"F (1, 2 or 3 way).
The temperature regulator lever is pre-set at 38°C.
Use of a pressure reducer is recommended if pressures in the system exceed 5 bar.

DATI TECNICI

Pressione dinamica minima 0,5 bar
Pressione di esercizio massima 5 bar
Pressione di utilizzo raccomandata da 1 a 5 bar
Temperatura massima acqua calda 80°C

CARATTERISTICHE GENERALI

Profondità di installazione da 80 mm a 90 mm.
Le entrate vengono fornite con filetto G1/2" femmina G3/4" maschio, le uscite solo G1/2"F (1, 2 o 3 vie).
La maniglia di regolazione temperatura, viene pre-settata a 38°C.
Si raccomanda l'utilizzo di un riduttore di pressione, se all'interno dell'impianto, si hanno pressioni superiori a 5 bar.

DONNÉES TECHNIQUES

Pression dynamique minimum 0,5 bar
Pression de service maximale de 5 bar
Pression d'utilisation conseillé de 1 à 5 bar
Température maximale de l'eau chaude 80 ° C

CARACTERISTIQUES GENERALES

Profondeur de montage de 80 mm à 90 mm.
Les entrées sont fournis avec filetage G1/2" femelle G3/4" mâle, les sorties G1/2"F (1,2,ou 3 voies).
La poignée de réglage de la température, est pré-réglée à 38 ° C Si à l'intérieur du système vous avez des pressions supérieures à 5 bars, il est recommandé l'utilisation d'un réducteur de pression..

Built-in part - Parte incasso - Corps encastré

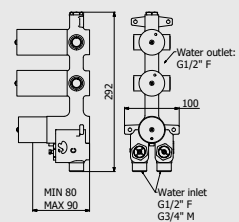

Plate and handles - Parte esterna - Plaque et poignée

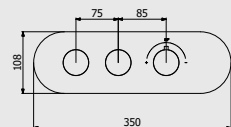
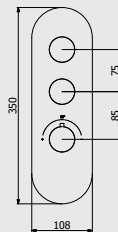

Plate and handles - Parte esterna - Plaque et poignée



PACKAGING

L: 240 mm D: 115 mm H: 160 mm 3,9 kg

ORIENTATION | ORIENTAZIONE | ORIENTATION

2 ways to installation: horizontal or vertical
2 modalità di installazione: verticale o orizzontale
2 modalitè de installation: vertical ou horizontal .

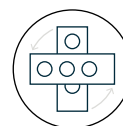

FOR ALL MODELS
PER TUTTI I MODELLI
POUR TOUS LES MODÈLES



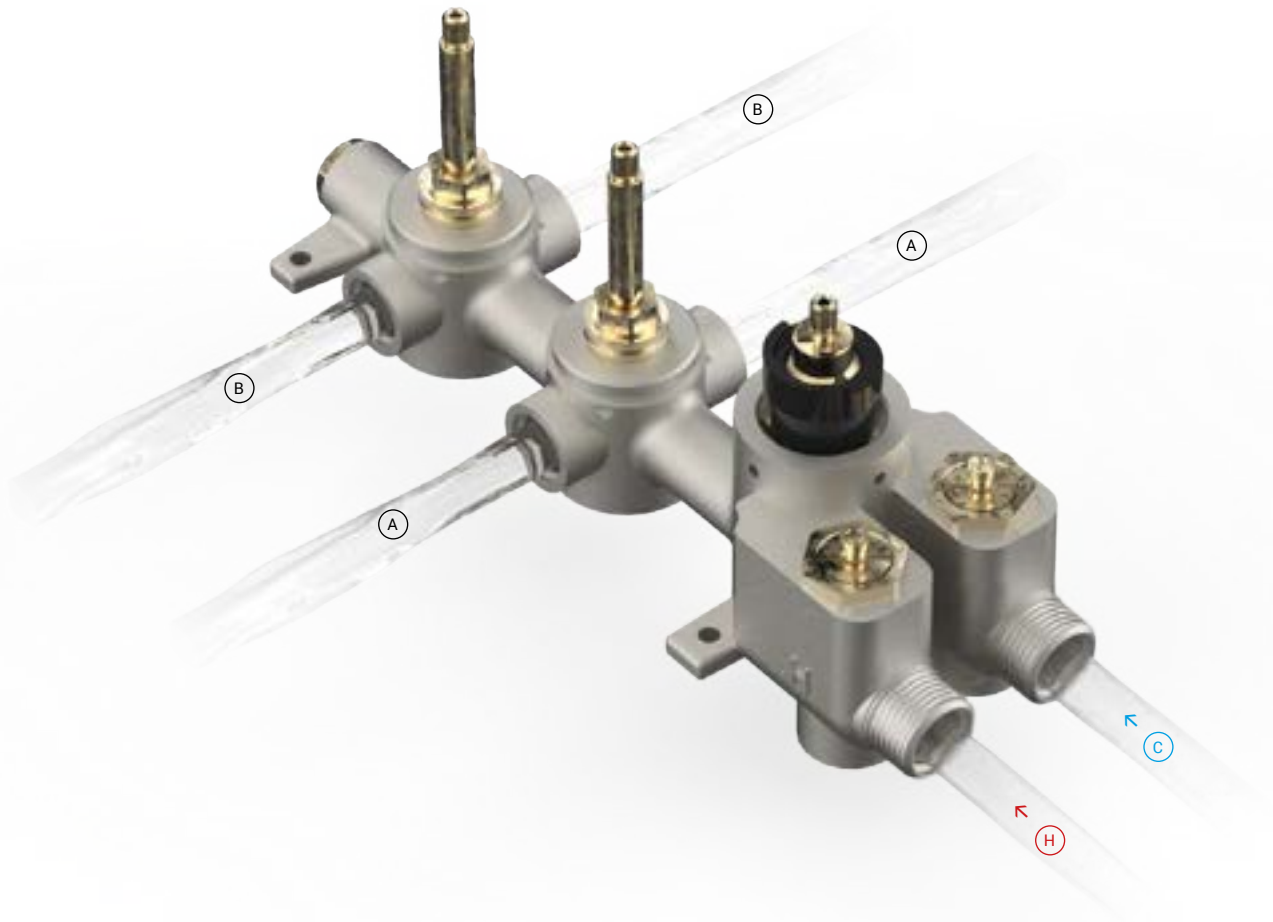

A Mixed water outlet
Uscita acqua miscelata
Sortie eau mélangé



B Mixed water outlet
Uscita acqua miscelata
Sortie eau mélangé



H Hot water
Acqua calda
Eau chaude



C Cold water
Acqua fredda
Eau froide

Aqua

PORTATE | WATER FLOW | DÉBIT D'EAU

| 0.2 BAR | 0.5 BAR | 1 BAR | 2 BAR | 3 BAR | 4 BAR | 5 BAR |
|----------|---------|--------|--------|--------|--------|--------|
| 10,7 l/m | 18 l/m | 26 l/m | 37 l/m | 45 l/m | 51 l/m | 56 l/m |

Hey Joe!



RECESSED BODY
CORPO INCASSO
PARTIE ENCASTRÉ
IUA200CCXN_1 9,5

PACKAGING

L: 530 mm
D: 145 mm
H: 90 mm

4,16 kg



VERTICAL | VERTICALE | VERTICAL

PLATE AND HANDLES TRIMKIT
KIT PIASTRA E MANIGLIE
KIT PLAQUE ET POIGNÉE

| | | |
|----|-------------|------|
| CC | EUA212CCNHJ | 21,8 |
| SS | EUA212SSNHJ | 27,3 |
| BO | EUA212BONHJ | 26,2 |
| NP | EUA212NPNHJ | 26,2 |
| CF | EUA212CFNHJ | 32,7 |
| CS | EUA212CSNHJ | 34,9 |
| OO | EUA212OONHJ | 32,7 |
| II | EUA212IINHJ | 32,7 |
| IS | EUA212ISNHJ | 34,9 |
| RS | EUA212RSNHJ | 32,7 |
| SR | EUA212SRNHJ | 34,9 |
| OS | EUA212OSNHJ | 34,9 |

HORIZONTAL | ORIZZONTALE | HORIZONTAL

PLATE AND HANDLES TRIMKIT
KIT PIASTRA E MANIGLIE
KIT PLAQUE ET POIGNÉE

| | | |
|----|-------------|------|
| CC | EUA222CCNHJ | 21,8 |
| SS | EUA222SSNHJ | 27,3 |
| BO | EUA222BONHJ | 26,2 |
| NP | EUA222NPNHJ | 26,2 |
| CF | EUA222CFNHJ | 32,7 |
| CS | EUA222CSNHJ | 34,9 |
| OO | EUA222OONHJ | 32,7 |
| II | EUA222IINHJ | 32,7 |
| IS | EUA222ISNHJ | 34,9 |
| RS | EUA222RSNHJ | 32,7 |
| SR | EUA222SRNHJ | 34,9 |
| OS | EUA222OSNHJ | 34,9 |

Loveme



RECESSED BODY
CORPO INCASSO
PARTIE ENCASTRÉ
IUA200CCXN_1 9,5

PACKAGING

L: 530 mm
D: 145 mm
H: 90 mm

4,16 kg



VERTICAL | VERTICALE | VERTICAL

PLATE AND HANDLES TRIMKIT
KIT PIASTRA E MANIGLIE
KIT PLAQUE ET POIGNÉE

| | | |
|----|-------------|------|
| CC | EUA212CCNLM | 21,8 |
| SS | EUA212SSNLM | 27,3 |
| BO | EUA212BONLM | 26,2 |
| NP | EUA212NPNLM | 26,2 |
| CS | EUA212CSNLM | 34,9 |
| IS | EUA212ISNLM | 34,9 |
| SR | EUA212SRNLM | 34,9 |
| OS | EUA212OSNLM | 34,9 |
| ON | EUA212ONNLM | 21,8 |

HORIZONTAL | ORIZZONTALE | HORIZONTAL

PLATE AND HANDLES TRIMKIT
KIT PIASTRA E MANIGLIE
KIT PLAQUE ET POIGNÉE

| | | |
|----|-------------|------|
| CC | EUA222CCNLM | 21,8 |
| SS | EUA222SSNLM | 27,3 |
| BO | EUA222BONLM | 26,2 |
| NP | EUA222NPNLM | 26,2 |
| CS | EUA222CSNLM | 34,9 |
| IS | EUA222ISNLM | 34,9 |
| SR | EUA222SRNLM | 34,9 |
| OS | EUA222OSNLM | 34,9 |
| ON | EUA222ONNLM | 21,8 |

Belmondo



RECESSED BODY
CORPO INCASSO
PARTIE ENCASTRÉ
IUA200CCXN_1 9,5

PACKAGING

L: 530 mm
D: 145 mm
H: 90 mm

4,16 kg



VERTICAL | VERTICALE | VERTICAL

PLATE AND HANDLES TRIMKIT
KIT PIASTRA E MANIGLIE
KIT PLAQUE ET POIGNÉE

| | | |
|----|-------------|------|
| CC | EUA212CCNBT | 21,8 |
| OO | EUA212OONBT | 32,7 |
| II | EUA212IINBT | 32,7 |
| RS | EUA212RSNBT | 32,7 |
| PL | EUA212PLNBT | 34,9 |

HORIZONTAL | ORIZZONTALE | HORIZONTAL

PLATE AND HANDLES TRIMKIT
KIT PIASTRA E MANIGLIE
KIT PLAQUE ET POIGNÉE

| | | |
|----|-------------|------|
| CC | EUA222CCNBT | 21,8 |
| OO | EUA222OONBT | 32,7 |
| II | EUA222IINBT | 32,7 |
| RS | EUA222RSNBT | 32,7 |
| PL | EUA222PLNBT | 34,9 |

Batlò



RECESSED BODY
CORPO INCASSO
PARTIE ENCASTRÉ
IUA200CCXN_1 9,5

PACKAGING

L: 530 mm
D: 145 mm
H: 90 mm

4,16 kg



VERTICAL | VERTICALE | VERTICAL

PLATE AND HANDLES TRIMKIT
KIT PIASTRA E MANIGLIE
KIT PLAQUE ET POIGNÉE

| | | |
|----|-------------|------|
| CC | EUA212CCNBI | 21,8 |
| SS | EUA212SSNBI | 27,3 |
| BO | EUA212BONBI | 26,2 |
| NP | EUA212NPNBI | 26,2 |
| CF | EUA212CFNBI | 32,7 |
| CS | EUA212CSNBI | 34,9 |
| OO | EUA212OONBI | 32,7 |
| II | EUA212IINBI | 32,7 |
| IS | EUA212ISNBI | 34,9 |
| RS | EUA212RSNBI | 32,7 |
| SR | EUA212SRNBI | 34,9 |
| OS | EUA212OSNBI | 34,9 |

HORIZONTAL | ORIZZONTALE | HORIZONTAL

PLATE AND HANDLES TRIMKIT
KIT PIASTRA E MANIGLIE
KIT PLAQUE ET POIGNÉE

| | | |
|----|-------------|------|
| CC | EUA222CCNBI | 21,8 |
| SS | EUA222SSNBI | 27,3 |
| BO | EUA222BONBI | 26,2 |
| NP | EUA222NPNBI | 26,2 |
| CF | EUA222CFNBI | 32,7 |
| CS | EUA222CSNBI | 34,9 |
| OO | EUA222OONBI | 32,7 |
| II | EUA222IINBI | 32,7 |
| IS | EUA222ISNBI | 34,9 |
| RS | EUA222RSNBI | 32,7 |
| SR | EUA222SRNBI | 34,9 |
| OS | EUA222OSNBI | 34,9 |

Kusasi



RECESSED BODY
CORPO INCASSO
PARTIE ENCASTRÉ
IUA200CCXN_1 9,5

PACKAGING

L: 530 mm
D: 145 mm
H: 90 mm

4,16 kg



VERTICAL | VERTICALE | VERTICAL

PLATE AND HANDLES TRIMKIT
KIT PIASTRA E MANIGLIE
KIT PLAQUE ET POIGNÉE

| | | |
|----|-------------|------|
| CC | EUA212CCNKU | 21,8 |
| SS | EUA212SSNKU | 27,3 |
| NP | EUA212NPNKU | 26,2 |

HORIZONTAL | ORIZZONTALE | HORIZONTAL

PLATE AND HANDLES TRIMKIT
KIT PIASTRA E MANIGLIE
KIT PLAQUE ET POIGNÉE

| | | |
|----|-------------|------|
| CC | EUA122CCNKU | 21,8 |
| SS | EUA122SSNKU | 27,3 |
| NP | EUA122NPNKU | 26,2 |

Wow

RECESSED BODY
CORPO INCASSO
PARTIE ENCASTRÉ

IUA200CCXN_1 9,5







PACKAGING

 L: 530 mm
D: 145 mm
H: 90 mm

 4,16 kg





VERTICAL | VERTICALE | VERTICAL

PLATE AND HANDLES TRIMKIT
KIT PIASTRA E MANIGLIE
KIT PLAQUE ET POIGNÉE

| | | | |
|---|----|-------------|------|
|  | CC | EUA212CCNWO | 21,8 |
|  | SS | EUA212SSNWO | 27,3 |
|  | BO | EUA212BONWO | 26,2 |
|  | NP | EUA212NPNWO | 26,2 |
|  | OO | EUA212OONWO | 32,7 |

HORIZONTAL | ORIZZONTALE | HORIZONTAL

PLATE AND HANDLES TRIMKIT
KIT PIASTRA E MANIGLIE
KIT PLAQUE ET POIGNÉE

| | | | |
|---|----|-------------|------|
|  | CC | EUA222CCNWO | 21,8 |
|  | SS | EUA222SSNWO | 27,3 |
|  | BO | EUA222BONWO | 26,2 |
|  | NP | EUA222NPNWO | 26,2 |
|  | OO | EUA222OONWO | 32,7 |

Industria

RECESSED BODY
CORPO INCASSO
PARTIE ENCASTRÉ

IUA200CCXN_1 9,5















PACKAGING

 L: 530 mm
D: 145 mm
H: 90 mm

 4,16 kg













VERTICAL | VERTICALE | VERTICAL

PLATE AND HANDLES TRIMKIT
KIT PIASTRA E MANIGLIE
KIT PLAQUE ET POIGNÉE

| | | | |
|---|----|--------------|------|
|  | CC | EUA212CCNID1 | 21,8 |
|  | SS | EUA212SSNID1 | 27,3 |
|  | NP | EUA212NPNID1 | 26,2 |
|  | CF | EUA212CFNID1 | 32,7 |
|  | CS | EUA212CSNID1 | 34,9 |
|  | OO | EUA212OONID1 | 32,7 |
|  | II | EUA212IINID1 | 32,7 |
|  | IS | EUA212ISNID1 | 34,9 |
|  | RS | EUA212RSNID1 | 32,7 |
|  | SR | EUA212SRNID1 | 34,9 |
|  | OS | EUA212OSNID1 | 34,9 |
|  | ON | EUA212ONNID1 | 21,8 |

HORIZONTAL | ORIZZONTALE | HORIZONTAL

PLATE AND HANDLES TRIMKIT
KIT PIASTRA E MANIGLIE
KIT PLAQUE ET POIGNÉE

| | | | |
|---|----|--------------|------|
|  | CC | EUA222CCNID1 | 21,8 |
|  | SS | EUA222SSNID1 | 27,3 |
|  | NP | EUA222NPNID1 | 26,2 |
|  | CF | EUA222CFNID1 | 32,7 |
|  | CS | EUA222CSNID1 | 34,9 |
|  | OO | EUA222OONID1 | 32,7 |
|  | II | EUA222IINID1 | 32,7 |
|  | IS | EUA222ISNID1 | 34,9 |
|  | RS | EUA222RSNID1 | 32,7 |
|  | SR | EUA222SRNID1 | 34,9 |
|  | OS | EUA222OSNID1 | 34,9 |
|  | ON | EUA222ONNID1 | 21,8 |

Bold

RECESSED BODY
CORPO INCASSO
PARTIE ENCASTRÉ

IUA200CCXN_1 9,5















PACKAGING

 L: 530 mm
D: 145 mm
H: 90 mm

 4,16 kg













VERTICAL | VERTICALE | VERTICAL

PLATE AND HANDLES TRIMKIT
KIT PIASTRA E MANIGLIE
KIT PLAQUE ET POIGNÉE

| | | | |
|---|----|-------------|------|
|  | CC | EUA212CCNB1 | 23,1 |
|  | SS | EUA212SSNB1 | 28,9 |
|  | NP | EUA212NPNB1 | 27,8 |
|  | CF | EUA212CFNB1 | 34,7 |
|  | CS | EUA212CSNB1 | 37,0 |
|  | OO | EUA212OONB1 | 34,7 |
|  | II | EUA212IINB1 | 34,7 |
|  | IS | EUA212ISNB1 | 37,0 |
|  | RS | EUA212RSNB1 | 34,7 |
|  | SR | EUA212SRNB1 | 37,0 |
|  | OS | EUA212OSNB1 | 37,0 |
|  | ON | EUA212ONNB1 | 23,1 |

HORIZONTAL | ORIZZONTALE | HORIZONTAL

PLATE AND HANDLES TRIMKIT
KIT PIASTRA E MANIGLIE
KIT PLAQUE ET POIGNÉE

| | | | |
|---|----|-------------|------|
|  | CC | EUA222CCNB1 | 23,1 |
|  | SS | EUA222SSNB1 | 28,9 |
|  | NP | EUA222NPNB1 | 27,8 |
|  | CF | EUA222CFNB1 | 34,7 |
|  | CS | EUA222CSNB1 | 37,0 |
|  | OO | EUA222OONB1 | 34,7 |
|  | II | EUA222IINB1 | 34,7 |
|  | IS | EUA222ISNB1 | 37,0 |
|  | RS | EUA222RSNB1 | 34,7 |
|  | SR | EUA222SRNB1 | 37,0 |
|  | OS | EUA222OSNB1 | 37,0 |
|  | ON | EUA222ONNB1 | 23,1 |

Birkin

RECESSED BODY
CORPO INCASSO
PARTIE ENCASTRÉ

IUA200CCXN_1 9,5







PACKAGING

 L: 530 mm
D: 145 mm
H: 90 mm

 4,16 kg



VERTICAL | VERTICALE | VERTICAL

PLATE AND HANDLES TRIMKIT
KIT PIASTRA E MANIGLIE
KIT PLAQUE ET POIGNÉE

| | | | |
|---|----|--------------|------|
|  | CC | EUA212CCNBR3 | 29,2 |
|  | SS | EUA212SSNBR3 | 36,5 |
|  | RS | EUA212RSNBR3 | 43,7 |
|  | OS | EUA212OSNBR3 | 46,7 |
|  | PL | EUA212PLNBR3 | 46,7 |

HORIZONTAL | ORIZZONTALE | HORIZONTAL

PLATE AND HANDLES TRIMKIT
KIT PIASTRA E MANIGLIE
KIT PLAQUE ET POIGNÉE

| | | | |
|---|----|--------------|------|
|  | CC | EUA222CCNBR3 | 29,2 |
|  | SS | EUA222SSNBR3 | 36,5 |
|  | RS | EUA222RSNBR3 | 43,7 |
|  | OS | EUA222OSNBR3 | 46,7 |
|  | PL | EUA222PLNBR3 | 46,7 |

Marmo

RECESSED BODY
CORPO INCASSO
PARTIE ENCASTRÉ

IUA200CCXN_1 9,5





PACKAGING

 L: 530 mm
D: 145 mm
H: 90 mm

 4,28 kg

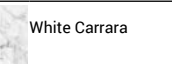













MARBLE

 White Carrara

 Black Marquina















VERTICAL | VERTICALE | VERTICAL

PLATE AND HANDLES TRIMKIT
KIT PIASTRA E MANIGLIE
KIT PLAQUE ET POIGNÉE

| | | | | |
|---|----|--------------|--------------|------|
|  | CC | EUA212CCNMR1 | EUA212CCNMR2 | 26,8 |
|  | SS | EUA212SSNMR1 | EUA212SSNMR2 | 33,5 |
|  | BO | EUA212BONMR1 | EUA212BONMR2 | 32,2 |
|  | NP | EUA212NPNMR1 | EUA212NPNMR2 | 32,2 |
|  | CF | EUA212CFNMR1 | EUA212CFNMR2 | 40,2 |
|  | CS | EUA212CSNMR1 | EUA212CSNMR2 | 42,9 |
|  | OO | EUA212OONMR1 | EUA212OONMR2 | 40,2 |
|  | II | EUA212IINMR1 | EUA212IINMR2 | 40,2 |
|  | IS | EUA212ISNMR1 | EUA212ISNMR2 | 42,9 |
|  | RS | EUA212RSNMR1 | EUA212RSNMR2 | 40,2 |
|  | SR | EUA212SRNMR1 | EUA212SRNMR2 | 42,9 |
|  | OS | EUA212OSNMR1 | EUA212OSNMR2 | 42,9 |
|  | ON | EUA212ONNMR1 | EUA212PLNMR2 | 26,8 |
|  | PL | EUA212PLNMR1 | EUA212PLNMR2 | 42,9 |

HORIZONTAL | ORIZZONTALE | HORIZONTAL

PLATE AND HANDLES TRIMKIT
KIT PIASTRA E MANIGLIE
KIT PLAQUE ET POIGNÉE

| | | | | |
|---|----|--------------|--------------|------|
|  | CC | EUA222CCNMR1 | EUA222CCNMR2 | 26,8 |
|  | SS | EUA222SSNMR1 | EUA222SSNMR2 | 33,5 |
|  | BO | EUA222BONMR1 | EUA222BONMR2 | 32,2 |
|  | NP | EUA222NPNMR1 | EUA222NPNMR2 | 32,2 |
|  | CF | EUA222CFNMR1 | EUA222CFNMR2 | 40,2 |
|  | CS | EUA222CSNMR1 | EUA222CSNMR2 | 42,9 |
|  | OO | EUA222OONMR1 | EUA222OONMR2 | 40,2 |
|  | II | EUA222IINMR1 | EUA222IINMR2 | 40,2 |
|  | IS | EUA222ISNMR1 | EUA222ISNMR2 | 42,9 |
|  | RS | EUA222RSNMR1 | EUA222RSNMR2 | 40,2 |
|  | SR | EUA222SRNMR1 | EUA222SRNMR2 | 42,9 |
|  | OS | EUA222OSNMR1 | EUA222OSNMR2 | 42,9 |
|  | ON | EUA222ONNMR1 | EUA222PLNMR2 | 26,8 |
|  | PL | EUA222PLNMR1 | EUA222PLNMR2 | 42,9 |

Aqua

Rubacuori



RECESSED BODY
CORPO INCASSO
PARTIE ENCASTRÉ
IUA200CCXN_1 9,5

PACKAGING

L: 530 mm
D: 145 mm
H: 90 mm

4,16 kg



VERTICAL | VERTICALE | VERTICAL

PLATE AND HANDLES TRIMKIT
KIT PIASTRÀ E MANIGLIE
KIT PLAQUE ET POIGNÉE

| | | |
|----|-------------|------|
| CC | EUA211CCNRU | 21,8 |
| SS | EUA211SSNRU | 27,3 |
| BO | EUA211BONRU | 26,2 |
| NP | EUA211NPNRU | 26,2 |
| CF | EUA211CFNRU | 32,7 |
| CS | EUA211CSNRU | 34,9 |
| OO | EUA211OONRU | 32,7 |
| II | EUA211IINRU | 32,7 |
| IS | EUA211ISNRU | 34,9 |
| RS | EUA211RSNRU | 32,7 |
| SR | EUA211SRNRU | 34,9 |
| OS | EUA211OSNRU | 34,9 |

HORIZONTAL | ORIZZONTALE | HORIZONTAL

PLATE AND HANDLES TRIMKIT
KIT PIASTRÀ E MANIGLIE
KIT PLAQUE ET POIGNÉE

| | | |
|----|-------------|------|
| CC | EUA221CCNRU | 21,8 |
| SS | EUA221SSNRU | 27,3 |
| BO | EUA221BONRU | 26,2 |
| NP | EUA221NPNRU | 26,2 |
| CF | EUA221CFNRU | 32,7 |
| CS | EUA221CSNRU | 34,9 |
| OO | EUA221OONRU | 32,7 |
| II | EUA221IINRU | 32,7 |
| IS | EUA221ISNRU | 34,9 |
| RS | EUA221RSNRU | 32,7 |
| SR | EUA221SRNRU | 34,9 |
| OS | EUA221OSNRU | 34,9 |

Hey joe!



RECESSED BODY
CORPO INCASSO
PARTIE ENCASTRÉ
IUA200CCXN_1 9,5

PACKAGING

L: 530 mm
D: 145 mm
H: 90 mm

4,16 kg



VERTICAL | VERTICALE | VERTICAL

PLATE AND HANDLES TRIMKIT
KIT PIASTRÀ E MANIGLIE
KIT PLAQUE ET POIGNÉE

| | | |
|----|-------------|------|
| CC | EUA211CCNHJ | 21,8 |
| SS | EUA211SSNHJ | 27,3 |
| BO | EUA211BONHJ | 26,2 |
| NP | EUA211NPNHJ | 26,2 |
| CF | EUA211CFNHJ | 32,7 |
| CS | EUA211CSNHJ | 34,9 |
| OO | EUA211OONHJ | 32,7 |
| II | EUA211IINHJ | 32,7 |
| IS | EUA211ISNHJ | 34,9 |
| RS | EUA211RSNHJ | 32,7 |
| SR | EUA211SRNHJ | 34,9 |
| OS | EUA211OSNHJ | 34,9 |

HORIZONTAL | ORIZZONTALE | HORIZONTAL

PLATE AND HANDLES TRIMKIT
KIT PIASTRÀ E MANIGLIE
KIT PLAQUE ET POIGNÉE

| | | |
|----|-------------|------|
| CC | EUA221CCNHJ | 21,8 |
| SS | EUA221SSNHJ | 27,3 |
| BO | EUA221BONHJ | 26,2 |
| NP | EUA221NPNHJ | 26,2 |
| CF | EUA221CFNHJ | 32,7 |
| CS | EUA221CSNHJ | 34,9 |
| OO | EUA221OONHJ | 32,7 |
| II | EUA221IINHJ | 32,7 |
| IS | EUA221ISNHJ | 34,9 |
| RS | EUA221RSNHJ | 32,7 |
| SR | EUA221SRNHJ | 34,9 |
| OS | EUA221OSNHJ | 34,9 |

Belmondo



RECESSED BODY
CORPO INCASSO
PARTIE ENCASTRÉ
IUA200CCXN_1 9,5

PACKAGING

L: 530 mm
D: 145 mm
H: 90 mm

4,16 kg



VERTICAL | VERTICALE | VERTICAL

PLATE AND HANDLES TRIMKIT
KIT PIASTRÀ E MANIGLIE
KIT PLAQUE ET POIGNÉE

| | | |
|----|-------------|------|
| CC | EUA211CCNBT | 21,8 |
| OO | EUA211OONBT | 32,7 |
| II | EUA211IINBT | 32,7 |
| RS | EUA211RSNBT | 32,7 |
| PL | EUA211PLNBT | 34,9 |

HORIZONTAL | ORIZZONTALE | HORIZONTAL

PLATE AND HANDLES TRIMKIT
KIT PIASTRÀ E MANIGLIE
KIT PLAQUE ET POIGNÉE

| | | |
|----|-------------|------|
| CC | EUA221CCNBT | 21,8 |
| OO | EUA221OONBT | 32,7 |
| II | EUA221IINBT | 32,7 |
| RS | EUA221RSNBT | 32,7 |
| PL | EUA221PLNBT | 34,9 |

Kusasi



RECESSED BODY
CORPO INCASSO
PARTIE ENCASTRÉ
IUA200CCXN_1 9,5

PACKAGING

L: 530 mm
D: 145 mm
H: 90 mm

4,16 kg



VERTICAL | VERTICALE | VERTICAL

PLATE AND HANDLES TRIMKIT
KIT PIASTRÀ E MANIGLIE
KIT PLAQUE ET POIGNÉE

| | | |
|----|-------------|------|
| CC | EUA211CCNKU | 21,8 |
| SS | EUA211SSNKU | 27,3 |
| NP | EUA211NPNKU | 26,2 |

HORIZONTAL | ORIZZONTALE | HORIZONTAL

PLATE AND HANDLES TRIMKIT
KIT PIASTRÀ E MANIGLIE
KIT PLAQUE ET POIGNÉE

| | | |
|----|-------------|------|
| CC | EUA221CCNKU | 21,8 |
| SS | EUA221SSNKU | 27,3 |
| NP | EUA221NPNKU | 26,2 |

Wow



RECESSED BODY
CORPO INCASSO
PARTIE ENCASTRÉ
IUA200CCXN_1 9,5

PACKAGING

L: 530 mm
D: 145 mm
H: 90 mm

4,16 kg



VERTICAL | VERTICALE | VERTICAL

PLATE AND HANDLES TRIMKIT
KIT PIASTRÀ E MANIGLIE
KIT PLAQUE ET POIGNÉE

| | | |
|----|-------------|------|
| CC | EUA211CCNWO | 21,8 |
| SS | EUA211SSNWO | 27,3 |
| BO | EUA211BONWO | 26,2 |
| NP | EUA211NPNWO | 26,2 |
| OO | EUA211OONWO | 32,7 |

HORIZONTAL | ORIZZONTALE | HORIZONTAL

PLATE AND HANDLES TRIMKIT
KIT PIASTRÀ E MANIGLIE
KIT PLAQUE ET POIGNÉE

| | | |
|----|-------------|------|
| CC | EUA221CCNWO | 21,8 |
| SS | EUA221SSNWO | 27,3 |
| BO | EUA221BONWO | 26,2 |
| NP | EUA221NPNWO | 26,2 |
| OO | EUA221OONWO | 32,7 |

Industria

RECESSED BODY
CORPO INCASSO
PARTIE ENCASTRÉ

IUA200CCXN_1 9,5

PACKAGING

L: 530 mm
D: 145 mm
H: 90 mm

4,16 kg

VERTICAL | VERTICALE | VERTICAL

PLATE AND HANDLES TRIMKIT
KIT PIASTRA E MANIGLIE
KIT PLAQUE ET POIGNÉE

| | | |
|----|--------------|------|
| CC | EUA211CCNID1 | 21,8 |
| SS | EUA211SSNID1 | 27,3 |
| NP | EUA211NPNID1 | 26,2 |
| CF | EUA211CFNID1 | 32,7 |
| CS | EUA211CSNID1 | 34,9 |
| OO | EUA211OONID1 | 32,7 |
| II | EUA211IINID1 | 32,7 |
| IS | EUA211ISNID1 | 34,9 |
| RS | EUA211RSNID1 | 32,7 |
| SR | EUA211SRNID1 | 34,9 |
| OS | EUA211OSNID1 | 34,9 |
| ON | EUA211ONNID1 | 21,8 |

HORIZONTAL | ORIZZONTALE | HORIZONTAL

PLATE AND HANDLES TRIMKIT
KIT PIASTRA E MANIGLIE
KIT PLAQUE ET POIGNÉE

| | | |
|----|--------------|------|
| CC | EUA221CCNID1 | 21,8 |
| SS | EUA221SSNID1 | 27,3 |
| NP | EUA221NPNID1 | 26,2 |
| CF | EUA221CFNID1 | 32,7 |
| CS | EUA221CSNID1 | 34,9 |
| OO | EUA221OONID1 | 32,7 |
| II | EUA221IINID1 | 32,7 |
| IS | EUA221ISNID1 | 34,9 |
| RS | EUA221RSNID1 | 32,7 |
| SR | EUA221SRNID1 | 34,9 |
| OS | EUA221OSNID1 | 34,9 |
| ON | EUA221ONNID1 | 21,8 |

Marmo

RECESSED BODY
CORPO INCASSO
PARTIE ENCASTRÉ

IUA200CCXN_1 9,5

L: 530 mm
D: 145 mm
H: 90 mm

4,28 kg

MARBLE

White Carrara

Black Marquina

VERTICAL | VERTICALE | VERTICAL

PLATE AND HANDLES TRIMKIT
KIT PIASTRA E MANIGLIE
KIT PLAQUE ET POIGNÉE

| | | | |
|----|--------------|--------------|------|
| CC | EUA211CCNMR1 | EUA211CCNMR2 | 26,8 |
| SS | EUA211SSNMR1 | EUA211SSNMR2 | 33,5 |
| BO | EUA211BONMR1 | EUA211BONMR2 | 32,2 |
| NP | EUA211NPNMR1 | EUA211NPNMR2 | 32,2 |
| CF | EUA211CFNMR1 | EUA211CFNMR2 | 40,2 |
| CS | EUA211CSNMR1 | EUA211CSNMR2 | 42,9 |
| OO | EUA211OONMR1 | EUA211OONMR2 | 40,2 |
| II | EUA211IINMR1 | EUA211IINMR2 | 40,2 |
| IS | EUA211ISNMR1 | EUA211ISNMR2 | 42,9 |
| RS | EUA211RSNMR1 | EUA211RSNMR2 | 40,2 |
| SR | EUA211SRNMR1 | EUA211SRNMR2 | 42,9 |
| OS | EUA211OSNMR1 | EUA211OSNMR2 | 42,9 |
| ON | EUA211ONNMR1 | EUA211PLNMR2 | 26,8 |
| PL | EUA211PLNMR1 | EUA211PLNMR2 | 42,9 |

HORIZONTAL | ORIZZONTALE | HORIZONTAL

PLATE AND HANDLES TRIMKIT
KIT PIASTRA E MANIGLIE
KIT PLAQUE ET POIGNÉE

| | | | |
|----|--------------|--------------|------|
| CC | EUA221CCNMR1 | EUA221CCNMR2 | 26,8 |
| SS | EUA221SSNMR1 | EUA221SSNMR2 | 33,5 |
| BO | EUA221BONMR1 | EUA221BONMR2 | 32,2 |
| NP | EUA221NPNMR1 | EUA221NPNMR2 | 32,2 |
| CF | EUA221CFNMR1 | EUA221CFNMR2 | 40,2 |
| CS | EUA221CSNMR1 | EUA221CSNMR2 | 42,9 |
| OO | EUA221OONMR1 | EUA221OONMR2 | 40,2 |
| II | EUA221IINMR1 | EUA221IINMR2 | 40,2 |
| IS | EUA221ISNMR1 | EUA221ISNMR2 | 42,9 |
| RS | EUA221RSNMR1 | EUA221RSNMR2 | 40,2 |
| SR | EUA221SRNMR1 | EUA221SRNMR2 | 42,9 |
| OS | EUA221OSNMR1 | EUA221OSNMR2 | 42,9 |
| ON | EUA221ONNMR1 | EUA221PLNMR2 | 26,8 |
| PL | EUA221PLNMR1 | EUA221PLNMR2 | 42,9 |

Hermes

RECESSED BODY
CORPO INCASSO
PARTIE ENCASTRÉ

IUA200CCXN_1 9,5

PACKAGING

L: 530 mm
D: 145 mm
H: 90 mm

4,16 kg

VERTICAL | VERTICALE | VERTICAL

PLATE AND HANDLES TRIMKIT
KIT PIASTRA E MANIGLIE
KIT PLAQUE ET POIGNÉE

| | | |
|----|-------------|------|
| CC | EUA215CCNHR | 21,8 |
| SS | EUA215SSNHR | 27,3 |
| II | EUA215IINHR | 32,7 |
| RS | EUA215RSNHR | 32,7 |
| OS | EUA215OSNHR | 34,9 |
| RR | EUA215RRNHR | 30,5 |
| BB | EUA215BBNHR | 30,5 |
| PL | EUA215PLNHR | 34,9 |

HORIZONTAL | ORIZZONTALE | HORIZONTAL

PLATE AND HANDLES TRIMKIT
KIT PIASTRA E MANIGLIE
KIT PLAQUE ET POIGNÉE

| | | |
|----|-------------|------|
| CC | EUA225CCNHR | 21,8 |
| SS | EUA225SSNHR | 27,3 |
| II | EUA225IINHR | 32,7 |
| RS | EUA225RSNHR | 32,7 |
| OS | EUA225OSNHR | 34,9 |
| RR | EUA225RRNHR | 30,5 |
| BB | EUA225BBNHR | 30,5 |
| PL | EUA225PLNHR | 34,9 |

Birkin

RECESSED BODY
CORPO INCASSO
PARTIE ENCASTRÉ

IUA200CCXN_1 9,5

PACKAGING

L: 530 mm
D: 145 mm
H: 90 mm

4,16 kg

VERTICAL | VERTICALE | VERTICAL

PLATE AND HANDLES TRIMKIT
KIT PIASTRA E MANIGLIE
KIT PLAQUE ET POIGNÉE

| | | |
|----|--------------|------|
| CC | EUA215CCNBR3 | 29,2 |
| SS | EUA215SSNBR3 | 36,5 |
| RS | EUA215RSNBR3 | 43,7 |
| OS | EUA215OSNBR3 | 46,7 |
| PL | EUA215PLNBR3 | 46,7 |

HORIZONTAL | ORIZZONTALE | HORIZONTAL

PLATE AND HANDLES TRIMKIT
KIT PIASTRA E MANIGLIE
KIT PLAQUE ET POIGNÉE

| | | |
|----|--------------|------|
| CC | EUA225CCNBR3 | 29,2 |
| SS | EUA225SSNBR3 | 36,5 |
| RS | EUA225RSNBR3 | 43,7 |
| OS | EUA225OSNBR3 | 46,7 |
| PL | EUA225PLNBR3 | 46,7 |

Aqua

AQUA

Thermostatic 3 ways

Termostatico 3 vie
Thermostatique 3 voies

ARTICLE | ARTICOLO | ARTICLE

IUA300CCXN_1

Only the built-in 1½" thermostatic unit of compact size, horizontal / vertical installation
Solo parte incasso termostatico 1/2 " ingombro ridotto, installazione orizzontale / verticale.
Seulement partie encastré du thermostatique 1/2" économie d'espace, installation horizontale / vertical.

CODE / COEFFICIENT | CODICE / COEFFICIENTE | CODE / COEFFICIENT

10,3

TECHNICAL DATA

Minimum dynamic pressure 0,5 bar
Maximum operational pressure 5 bar
Recommended operational pressure da 1 a 5 bar
Maximum hot water temperature 80°C

GENERAL FEATURES

Installation depth from 80 mm to 90 mm.
The intakes are fitted with G1/2" female G3/4" Male threaded connection, the outlets only G1/2"F (1, 2 or 3 way).
The temperature regulator lever is pre-set at 38°C.
Use of a pressure reducer is recommended if pressures in the system exceed 5 bar.

DATI TECNICI

Pressione dinamica minima 0,5 bar
Pressione di esercizio massima 5 bar
Pressione di utilizzo raccomandata da 1 a 5 bar
Temperatura massima acqua calda 80°C

CARATTERISTICHE GENERALI

Profondità di installazione da 80 mm a 90 mm.
Le entrate vengono fornite con filetto G1/2" femmina G3/4" maschio, le uscite solo G1/2"F (1, 2 o 3 vie).
La maniglia di regolazione temperatura, viene pre-settata a 38°C.
Si raccomanda l'utilizzo di un riduttore di pressione, se all'interno dell'impianto, si hanno pressioni superiori a 5 bar.

DONNÉES TECHNIQUES

Pression dynamique minimum 0,5 bar
Pression de service maximale de 5 bar
Pression d'utilisation conseillé de 1 à 5 bar
Température maximale de l'eau chaude 80 ° C

CARACTERISTIQUES GENERALES

Profondeur de montage de 80 mm à 90 mm.
Les entrées sont fournis avec filetage G1/2" femelle G3/4" mâle, les sorties G1/2"F (1,2,ou 3 voies).
La poignée de réglage de la température, est pré-réglée à 38 ° C Si à l'intérieur du système vous avez des pressions supérieures à 5 bars, il est recommandé l'utilisation d'un réducteur de pression..

Built-in part - Parte incasso - Corps encastré

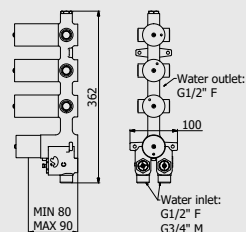

Plate and handles - Parte esterna - Plaque et poignée

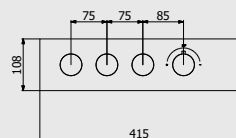
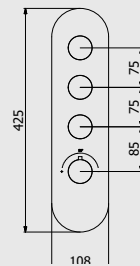

Plate and handles - Parte esterna - Plaque et poignée



PACKAGING

L: 310 mm D: 190 mm H: 165 mm 4,8 kg

ORIENTATION | ORIENTAZIONE | ORIENTATION

2 ways to installation: horizontal or vertical
2 modalità di installazione: verticale o orizzontale
2 modalitè de installation: vertical ou horizontal .

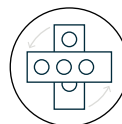

FOR ALL MODELS
PER TUTTI I MODELLI
POUR TOUS LES MODÈLES





A Mixed water outlet
Uscita acqua miscelata
Sortie eau mélangé



B Mixed water outlet
Uscita acqua miscelata
Sortie eau mélangé



C Mixed water outlet
Uscita acqua miscelata
Sortie eau mélangé



H Hot water
Acqua calda
Eau chaude



C Cold water
Acqua fredda
Eau froide

Aqua

PORTATE | WATER FLOW | DÉBIT D'EAU

| 0.2 BAR | 0.5 BAR | 1 BAR | 2 BAR | 3 BAR | 4 BAR | 5 BAR |
|----------|---------|--------|--------|--------|--------|--------|
| 10,7 l/m | 18 l/m | 26 l/m | 37 l/m | 45 l/m | 51 l/m | 56 l/m |

Hey Joe!



RECESSED BODY
CORPO INCASSO
PARTIE ENCASTRÉ
IUA300CCXN_1 10,3

PACKAGING

L: 530 mm
D: 145 mm
H: 90 mm

4,56 kg



VERTICAL | VERTICALE | VERTICAL

PLATE AND HANDLES TRIMKIT
KIT PIASTRA E MANIGLIE
KIT PLAQUE ET POIGNÉE



| | | |
|----|-------------|------|
| CC | EUA312CCNHJ | 25,9 |
| SS | EUA312SSNHJ | 32,4 |
| BO | EUA312BONHJ | 31,1 |
| NP | EUA312NPNHJ | 31,1 |
| CF | EUA312CFNHJ | 38,9 |
| CS | EUA312CSNHJ | 41,5 |
| OO | EUA312OONHJ | 38,9 |
| II | EUA312IINHJ | 38,9 |
| IS | EUA312ISNHJ | 41,5 |
| RS | EUA312RSNHJ | 38,9 |
| SR | EUA312SRNHJ | 41,5 |
| OS | EUA312OSNHJ | 41,5 |

HORIZONTAL | ORIZZONTALE | HORIZONTAL

PLATE AND HANDLES TRIMKIT
KIT PIASTRA E MANIGLIE
KIT PLAQUE ET POIGNÉE



| | | |
|----|-------------|------|
| CC | EUA322CCNHJ | 25,9 |
| SS | EUA322SSNHJ | 32,4 |
| BO | EUA322BONHJ | 31,1 |
| NP | EUA322NPNHJ | 31,1 |
| CF | EUA322CFNHJ | 38,9 |
| CS | EUA322CSNHJ | 41,5 |
| OO | EUA322OONHJ | 38,9 |
| II | EUA322IINHJ | 38,9 |
| IS | EUA322ISNHJ | 41,5 |
| RS | EUA322RSNHJ | 38,9 |
| SR | EUA322SRNHJ | 41,5 |
| OS | EUA322OSNHJ | 41,5 |

Loveme



RECESSED BODY
CORPO INCASSO
PARTIE ENCASTRÉ
IUA300CCXN_1 10,3

PACKAGING

L: 530 mm
D: 145 mm
H: 90 mm

4,56 kg



VERTICAL | VERTICALE | VERTICAL

PLATE AND HANDLES TRIMKIT
KIT PIASTRA E MANIGLIE
KIT PLAQUE ET POIGNÉE



| | | |
|----|-------------|------|
| CC | EUA312CCNLM | 25,9 |
| SS | EUA312SSNLM | 32,4 |
| BO | EUA312BONLM | 31,1 |
| NP | EUA312NPNLM | 31,1 |
| CS | EUA312CSNLM | 41,5 |
| IS | EUA312ISNLM | 41,5 |
| SR | EUA312SRNLM | 41,5 |
| OS | EUA312OSNLM | 41,5 |
| ON | EUA312ONNLM | 25,9 |

HORIZONTAL | ORIZZONTALE | HORIZONTAL

PLATE AND HANDLES TRIMKIT
KIT PIASTRA E MANIGLIE
KIT PLAQUE ET POIGNÉE



| | | |
|----|-------------|------|
| CC | EUA322CCNLM | 25,9 |
| SS | EUA322SSNLM | 32,4 |
| BO | EUA322BONLM | 31,1 |
| NP | EUA322NPNLM | 31,1 |
| CS | EUA322CSNLM | 41,5 |
| IS | EUA322ISNLM | 41,5 |
| SR | EUA322SRNLM | 41,5 |
| OS | EUA322OSNLM | 41,5 |
| ON | EUA322ONNLM | 25,9 |

Belmondo



RECESSED BODY
CORPO INCASSO
PARTIE ENCASTRÉ
IUA300CCXN_1 10,3

PACKAGING

L: 530 mm
D: 145 mm
H: 90 mm

4,56 kg



VERTICAL | VERTICALE | VERTICAL

PLATE AND HANDLES TRIMKIT
KIT PIASTRA E MANIGLIE
KIT PLAQUE ET POIGNÉE



| | | |
|----|-------------|------|
| CC | EUA312CCNBT | 25,9 |
| OO | EUA312OONBT | 38,9 |
| II | EUA312IINBT | 38,9 |
| RS | EUA312RSNBT | 38,9 |
| PL | EUA312PLNBT | 41,5 |

HORIZONTAL | ORIZZONTALE | HORIZONTAL

PLATE AND HANDLES TRIMKIT
KIT PIASTRA E MANIGLIE
KIT PLAQUE ET POIGNÉE



| | | |
|----|-------------|------|
| CC | EUA322CCNBT | 25,9 |
| OO | EUA322OONBT | 38,9 |
| II | EUA322IINBT | 38,9 |
| RS | EUA322RSNBT | 38,9 |
| PL | EUA322PLNBT | 41,5 |

Batlò



RECESSED BODY
CORPO INCASSO
PARTIE ENCASTRÉ
IUA300CCXN_1 10,3

PACKAGING

L: 530 mm
D: 145 mm
H: 90 mm

4,56 kg



VERTICAL | VERTICALE | VERTICAL

PLATE AND HANDLES TRIMKIT
KIT PIASTRA E MANIGLIE
KIT PLAQUE ET POIGNÉE



| | | |
|----|-------------|------|
| CC | EUA312CCNBI | 25,9 |
| SS | EUA312SSNBI | 32,4 |
| BO | EUA312BONBI | 31,1 |
| NP | EUA312NPNBI | 31,1 |
| CF | EUA312CFNBI | 38,9 |
| CS | EUA312CSNBI | 41,5 |
| OO | EUA312OONBI | 38,9 |
| II | EUA312IINBI | 38,9 |
| IS | EUA312ISNBI | 41,5 |
| RS | EUA312RSNBI | 38,9 |
| SR | EUA312SRNBI | 41,5 |
| OS | EUA312OSNBI | 41,5 |

HORIZONTAL | ORIZZONTALE | HORIZONTAL

PLATE AND HANDLES TRIMKIT
KIT PIASTRA E MANIGLIE
KIT PLAQUE ET POIGNÉE



| | | |
|----|-------------|------|
| CC | EUA322CCNBI | 25,9 |
| SS | EUA322SSNBI | 32,4 |
| BO | EUA322BONBI | 31,1 |
| NP | EUA322NPNBI | 31,1 |
| CF | EUA322CFNBI | 38,9 |
| CS | EUA322CSNBI | 41,5 |
| OO | EUA322OONBI | 38,9 |
| II | EUA322IINBI | 38,9 |
| IS | EUA322ISNBI | 41,5 |
| RS | EUA322RSNBI | 38,9 |
| SR | EUA322SRNBI | 41,5 |
| OS | EUA322OSNBI | 41,5 |

Kusasi



RECESSED BODY
CORPO INCASSO
PARTIE ENCASTRÉ
IUA300CCXN_1 10,3

PACKAGING

L: 530 mm
D: 145 mm
H: 90 mm

4,56 kg



VERTICAL | VERTICALE | VERTICAL

PLATE AND HANDLES TRIMKIT
KIT PIASTRA E MANIGLIE
KIT PLAQUE ET POIGNÉE



| | | |
|----|-------------|------|
| CC | EUA312CCNKU | 25,9 |
| SS | EUA312SSNKU | 32,4 |
| NP | EUA312NPNKU | 31,1 |

HORIZONTAL | ORIZZONTALE | HORIZONTAL

PLATE AND HANDLES TRIMKIT
KIT PIASTRA E MANIGLIE
KIT PLAQUE ET POIGNÉE



| | | |
|----|-------------|------|
| CC | EUA322CCNKU | 25,9 |
| SS | EUA322SSNKU | 32,4 |
| NP | EUA322NPNKU | 31,1 |

Wow

RECESSED BODY
CORPO INCASSO
PARTIE ENCASTRÉ

IUA300CCXN_1 10,3



PACKAGING

L: 530 mm
D: 145 mm
H: 90 mm

4,56 kg

VERTICAL | VERTICALE | VERTICAL

PLATE AND HANDLES TRIMKIT
KIT PIASTRA E MANIGLIE
KIT PLAQUE ET POIGNÉE

| | | |
|----|-------------|------|
| CC | EUA312CCNWO | 25,9 |
| SS | EUA312SSNWO | 32,4 |
| BO | EUA312BONWO | 31,1 |
| NP | EUA312NPNWO | 31,1 |
| OO | EUA312OONWO | 38,9 |

HORIZONTAL | ORIZZONTALE | HORIZONTAL

PLATE AND HANDLES TRIMKIT
KIT PIASTRA E MANIGLIE
KIT PLAQUE ET POIGNÉE

| | | |
|----|-------------|------|
| CC | EUA222CCNWO | 25,9 |
| SS | EUA222SSNWO | 32,4 |
| BO | EUA222BONWO | 31,1 |
| NP | EUA222NPNWO | 31,1 |
| OO | EUA222OONWO | 38,9 |

Industria

RECESSED BODY
CORPO INCASSO
PARTIE ENCASTRÉ

IUA300CCXN_1 10,3



PACKAGING

L: 530 mm
D: 145 mm
H: 90 mm

4,56 kg

VERTICAL | VERTICALE | VERTICAL

PLATE AND HANDLES TRIMKIT
KIT PIASTRA E MANIGLIE
KIT PLAQUE ET POIGNÉE

| | | |
|----|--------------|------|
| CC | EUA312CCNID1 | 25,9 |
| SS | EUA312SSNID1 | 32,4 |
| NP | EUA312NPNID1 | 31,1 |
| CF | EUA312CFNID1 | 38,9 |
| CS | EUA312CSNID1 | 41,5 |
| OO | EUA312OONID1 | 38,9 |
| II | EUA312IINID1 | 38,9 |
| IS | EUA312ISNID1 | 41,5 |
| RS | EUA312RSNID1 | 38,9 |
| SR | EUA312SRNID1 | 41,5 |
| OS | EUA312OSNID1 | 41,5 |
| ON | EUA312ONNID1 | 25,9 |

HORIZONTAL | ORIZZONTALE | HORIZONTAL

PLATE AND HANDLES TRIMKIT
KIT PIASTRA E MANIGLIE
KIT PLAQUE ET POIGNÉE

| | | |
|----|--------------|------|
| CC | EUA322CCNID1 | 25,9 |
| SS | EUA322SSNID1 | 32,4 |
| NP | EUA322NPNID1 | 31,1 |
| CF | EUA322CFNID1 | 38,9 |
| CS | EUA322CSNID1 | 41,5 |
| OO | EUA322OONID1 | 38,9 |
| II | EUA322IINID1 | 38,9 |
| IS | EUA322ISNID1 | 41,5 |
| RS | EUA322RSNID1 | 38,9 |
| SR | EUA322SRNID1 | 41,5 |
| OS | EUA322OSNID1 | 41,5 |
| ON | EUA322ONNID1 | 25,9 |

Bold

RECESSED BODY
CORPO INCASSO
PARTIE ENCASTRÉ

IUA300CCXN_1 10,3



PACKAGING

L: 530 mm
D: 145 mm
H: 90 mm

4,56 kg

VERTICAL | VERTICALE | VERTICAL

PLATE AND HANDLES TRIMKIT
KIT PIASTRA E MANIGLIE
KIT PLAQUE ET POIGNÉE

| | | |
|----|-------------|------|
| CC | EUA312CCNB1 | 28,0 |
| SS | EUA312SSNB1 | 34,9 |
| NP | EUA312NPNB1 | 33,5 |
| CF | EUA312CFNB1 | 41,9 |
| CS | EUA312CSNB1 | 44,7 |
| OO | EUA312OONB1 | 41,9 |
| II | EUA312IINB1 | 41,9 |
| IS | EUA312ISNB1 | 44,7 |
| RS | EUA312RSNB1 | 41,9 |
| SR | EUA312SRNB1 | 44,7 |
| OS | EUA312OSNB1 | 44,7 |
| ON | EUA312ONNB1 | 28,0 |

HORIZONTAL | ORIZZONTALE | HORIZONTAL

PLATE AND HANDLES TRIMKIT
KIT PIASTRA E MANIGLIE
KIT PLAQUE ET POIGNÉE

| | | |
|----|-------------|------|
| CC | EUA322CCNB1 | 28,0 |
| SS | EUA322SSNB1 | 34,9 |
| NP | EUA322NPNB1 | 33,5 |
| CF | EUA322CFNB1 | 41,9 |
| CS | EUA322CSNB1 | 44,7 |
| OO | EUA322OONB1 | 41,9 |
| II | EUA322IINB1 | 41,9 |
| IS | EUA322ISNB1 | 44,7 |
| RS | EUA322RSNB1 | 41,9 |
| SR | EUA322SRNB1 | 44,7 |
| OS | EUA322OSNB1 | 44,7 |
| ON | EUA322ONNB1 | 28,0 |

Birkin

RECESSED BODY
CORPO INCASSO
PARTIE ENCASTRÉ

IUA300CCXN_1 10,3



PACKAGING

L: 530 mm
D: 145 mm
H: 90 mm

4,56 kg

VERTICAL | VERTICALE | VERTICAL

PLATE AND HANDLES TRIMKIT
KIT PIASTRA E MANIGLIE
KIT PLAQUE ET POIGNÉE

| | | |
|----|--------------|------|
| CC | EUA312CCNBR3 | 36,0 |
| SS | EUA312SSNBR3 | 45,0 |
| RS | EUA312RSNBR3 | 54,0 |
| OS | EUA312OSNBR3 | 57,6 |
| PL | EUA312PLNBR3 | 57,6 |

HORIZONTAL | ORIZZONTALE | HORIZONTAL

PLATE AND HANDLES TRIMKIT
KIT PIASTRA E MANIGLIE
KIT PLAQUE ET POIGNÉE

| | | |
|----|--------------|------|
| CC | EUA322CCNBR3 | 36,0 |
| SS | EUA322SSNBR3 | 45,0 |
| RS | EUA322RSNBR3 | 54,0 |
| OS | EUA322OSNBR3 | 57,6 |
| PL | EUA322PLNBR3 | 57,6 |

Marmo

RECESSED BODY
CORPO INCASSO
PARTIE ENCASTRÉ

IUA300CCXN_1 10,3



PACKAGING

L: 530 mm
D: 145 mm
H: 90 mm

4,72 kg

MARBLE

White Carrara

Black Marquina



VERTICAL | VERTICALE | VERTICAL

PLATE AND HANDLES TRIMKIT
KIT PIASTRA E MANIGLIE
KIT PLAQUE ET POIGNÉE

| | | | |
|----|--------------|--------------|------|
| CC | EUA312CCNMR1 | EUA312CCNMR2 | 32,8 |
| SS | EUA312SSNMR1 | EUA312SSNMR2 | 41,0 |
| BO | EUA312BONMR1 | EUA312BONMR2 | 39,4 |
| NP | EUA312NPNMR1 | EUA312NPNMR2 | 39,4 |
| CF | EUA312CFNMR1 | EUA312CFNMR2 | 49,3 |
| CS | EUA312CSNMR1 | EUA312CSNMR2 | 52,5 |
| OO | EUA312OONMR1 | EUA312OONMR2 | 49,3 |
| II | EUA312IINMR1 | EUA312IINMR2 | 49,3 |
| IS | EUA312ISNMR1 | EUA312ISNMR2 | 52,5 |
| RS | EUA312RSNMR1 | EUA312RSNMR2 | 49,3 |
| SR | EUA312SRNMR1 | EUA312SRNMR2 | 52,5 |
| OS | EUA312OSNMR1 | EUA312OSNMR2 | 52,5 |
| ON | EUA312ONNMR1 | EUA312PLNMR2 | 32,8 |
| PL | EUA312PLNMR1 | EUA312PLNMR2 | 52,5 |

HORIZONTAL | ORIZZONTALE | HORIZONTAL

PLATE AND HANDLES TRIMKIT
KIT PIASTRA E MANIGLIE
KIT PLAQUE ET POIGNÉE

| | | | |
|----|--------------|--------------|------|
| CC | EUA322CCNMR1 | EUA322CCNMR2 | 32,8 |
| SS | EUA322SSNMR1 | EUA322SSNMR2 | 41,0 |
| BO | EUA322BONMR1 | EUA322BONMR2 | 39,4 |
| NP | EUA322NPNMR1 | EUA322NPNMR2 | 39,4 |
| CF | EUA322CFNMR1 | EUA322CFNMR2 | 49,3 |
| CS | EUA322CSNMR1 | EUA322CSNMR2 | 52,5 |
| OO | EUA322OONMR1 | EUA322OONMR2 | 49,3 |
| II | EUA322IINMR1 | EUA322IINMR2 | 49,3 |
| IS | EUA322ISNMR1 | EUA322ISNMR2 | 52,5 |
| RS | EUA322RSNMR1 | EUA322RSNMR2 | 49,3 |
| SR | EUA322SRNMR1 | EUA322SRNMR2 | 52,5 |
| OS | EUA322OSNMR1 | EUA322OSNMR2 | 52,5 |
| ON | EUA322ONNMR1 | EUA322PLNMR2 | 32,8 |
| PL | EUA322PLNMR1 | EUA322PLNMR2 | 52,5 |

Aqua

Rubacuori



RECESSED BODY
CORPO INCASSO
PARTIE ENCASTRÉ
IUA300CCXN_1 10,3

PACKAGING

L: 530 mm
D: 145 mm
H: 90 mm

4,56 kg



VERTICAL | VERTICALE | VERTICAL

PLATE AND HANDLES TRIMKIT
KIT PIASTRA E MANIGLIE
KIT PLAQUE ET POIGNÉE

| | | |
|----|-------------|------|
| CC | EUA311CCNRU | 25,9 |
| SS | EUA311SSNRU | 32,4 |
| BO | EUA311BONRU | 31,1 |
| NP | EUA311NPNRU | 31,1 |
| CF | EUA311CFNRU | 38,9 |
| CS | EUA311CSNRU | 41,5 |
| OO | EUA311OONRU | 38,9 |
| II | EUA311IINRU | 38,9 |
| IS | EUA311ISNRU | 41,5 |
| RS | EUA311RSNRU | 38,9 |
| SR | EUA311SRNRU | 41,5 |
| OS | EUA311OSNRU | 41,5 |

HORIZONTAL | ORIZZONTALE | HORIZONTAL

PLATE AND HANDLES TRIMKIT
KIT PIASTRA E MANIGLIE
KIT PLAQUE ET POIGNÉE

| | | |
|----|-------------|------|
| CC | EUA321CCNRU | 25,9 |
| SS | EUA321SSNRU | 32,4 |
| BO | EUA321BONRU | 31,1 |
| NP | EUA321NPNRU | 31,1 |
| CF | EUA321CFNRU | 38,9 |
| CS | EUA321CSNRU | 41,5 |
| OO | EUA321OONRU | 38,9 |
| II | EUA321IINRU | 38,9 |
| IS | EUA321ISNRU | 41,5 |
| RS | EUA321RSNRU | 38,9 |
| SR | EUA321SRNRU | 41,5 |
| OS | EUA321OSNRU | 41,5 |

Hey joe!



RECESSED BODY
CORPO INCASSO
PARTIE ENCASTRÉ
IUA300CCXN_1 10,3

PACKAGING

L: 530 mm
D: 145 mm
H: 90 mm

4,56 kg



VERTICAL | VERTICALE | VERTICAL

PLATE AND HANDLES TRIMKIT
KIT PIASTRA E MANIGLIE
KIT PLAQUE ET POIGNÉE

| | | |
|----|-------------|------|
| CC | EUA311CCNHJ | 25,9 |
| SS | EUA311SSNHJ | 32,4 |
| BO | EUA311BONHJ | 31,1 |
| NP | EUA311NPNHJ | 31,1 |
| CF | EUA311CFNHJ | 38,9 |
| CS | EUA311CSNHJ | 41,5 |
| OO | EUA311OONHJ | 38,9 |
| II | EUA311IINHJ | 38,9 |
| IS | EUA311ISNHJ | 41,5 |
| RS | EUA311RSNHJ | 38,9 |
| SR | EUA311SRNHJ | 41,5 |
| OS | EUA311OSNHJ | 41,5 |

HORIZONTAL | ORIZZONTALE | HORIZONTAL

PLATE AND HANDLES TRIMKIT
KIT PIASTRA E MANIGLIE
KIT PLAQUE ET POIGNÉE

| | | |
|----|-------------|------|
| CC | EUA321CCNHJ | 25,9 |
| SS | EUA321SSNHJ | 32,4 |
| BO | EUA321BONHJ | 31,1 |
| NP | EUA321NPNHJ | 31,1 |
| CF | EUA321CFNHJ | 38,9 |
| CS | EUA321CSNHJ | 41,5 |
| OO | EUA321OONHJ | 38,9 |
| II | EUA321IINHJ | 38,9 |
| IS | EUA321ISNHJ | 41,5 |
| RS | EUA321RSNHJ | 38,9 |
| SR | EUA321SRNHJ | 41,5 |
| OS | EUA321OSNHJ | 41,5 |

Belmondo



RECESSED BODY
CORPO INCASSO
PARTIE ENCASTRÉ
IUA300CCXN_1 10,3

PACKAGING

L: 530 mm
D: 145 mm
H: 90 mm

4,56 kg



VERTICAL | VERTICALE | VERTICAL

PLATE AND HANDLES TRIMKIT
KIT PIASTRA E MANIGLIE
KIT PLAQUE ET POIGNÉE

| | | |
|----|-------------|------|
| CC | EUA311CCNBT | 25,9 |
| OO | EUA311OONBT | 38,9 |
| II | EUA311IINBT | 38,9 |
| RS | EUA311RSNBT | 38,9 |
| PL | EUA311PLNBT | 41,5 |

HORIZONTAL | ORIZZONTALE | HORIZONTAL

PLATE AND HANDLES TRIMKIT
KIT PIASTRA E MANIGLIE
KIT PLAQUE ET POIGNÉE

| | | |
|----|-------------|------|
| CC | EUA321CCNBT | 25,9 |
| OO | EUA321OONBT | 38,9 |
| II | EUA321IINBT | 38,9 |
| RS | EUA321RSNBT | 38,9 |
| PL | EUA321PLNBT | 41,5 |

Kusasi



RECESSED BODY
CORPO INCASSO
PARTIE ENCASTRÉ
IUA300CCXN_1 10,3

PACKAGING

L: 530 mm
D: 145 mm
H: 90 mm

4,56 kg



VERTICAL | VERTICALE | VERTICAL

PLATE AND HANDLES TRIMKIT
KIT PIASTRA E MANIGLIE
KIT PLAQUE ET POIGNÉE

| | | |
|----|-------------|------|
| CC | EUA311CCNKU | 25,9 |
| SS | EUA311SSNKU | 32,4 |
| NP | EUA311NPNKU | 31,1 |

HORIZONTAL | ORIZZONTALE | HORIZONTAL

PLATE AND HANDLES TRIMKIT
KIT PIASTRA E MANIGLIE
KIT PLAQUE ET POIGNÉE

| | | |
|----|-------------|------|
| CC | EUA321CCNKU | 25,9 |
| SS | EUA321SSNKU | 32,4 |
| NP | EUA321NPNKU | 31,1 |

Wow



RECESSED BODY
CORPO INCASSO
PARTIE ENCASTRÉ
IUA300CCXN_1 10,3

PACKAGING

L: 530 mm
D: 145 mm
H: 90 mm

4,56 kg



VERTICAL | VERTICALE | VERTICAL

PLATE AND HANDLES TRIMKIT
KIT PIASTRA E MANIGLIE
KIT PLAQUE ET POIGNÉE

| | | |
|----|-------------|------|
| CC | EUA311CCNWO | 25,9 |
| SS | EUA311SSNWO | 32,4 |
| BO | EUA311BONWO | 31,1 |
| NP | EUA311NPNWO | 31,1 |
| OO | EUA311OONWO | 38,9 |

HORIZONTAL | ORIZZONTALE | HORIZONTAL

PLATE AND HANDLES TRIMKIT
KIT PIASTRA E MANIGLIE
KIT PLAQUE ET POIGNÉE

| | | |
|----|-------------|------|
| CC | EUA321CCNWO | 25,9 |
| SS | EUA321SSNWO | 32,4 |
| BO | EUA321BONWO | 31,1 |
| NP | EUA321NPNWO | 31,1 |
| OO | EUA321OONWO | 38,9 |

Industria

RECESSED BODY
CORPO INCASSO
PARTIE ENCASTRÉ

IUA300CCXN_1 10,3

PACKAGING

L: 530 mm
D: 145 mm
H: 90 mm

4,56 kg

VERTICAL | VERTICALE | VERTICAL

PLATE AND HANDLES TRIMKIT
KIT PIASTRA E MANIGLIE
KIT PLAQUE ET POIGNÉE

| | | |
|----|--------------|------|
| CC | EUA311CCNID1 | 25,9 |
| SS | EUA311SSNID1 | 32,4 |
| NP | EUA311NPNID1 | 31,1 |
| CF | EUA311CFNID1 | 38,9 |
| CS | EUA311CSNID1 | 41,5 |
| OO | EUA311OONID1 | 38,9 |
| II | EUA311IINID1 | 38,9 |
| IS | EUA311ISNID1 | 41,5 |
| RS | EUA311RSNID1 | 38,9 |
| SR | EUA311SRNID1 | 41,5 |
| OS | EUA311OSNID1 | 41,5 |
| ON | EUA311ONNID1 | 25,9 |

HORIZONTAL | ORIZZONTALE | HORIZONTAL

PLATE AND HANDLES TRIMKIT
KIT PIASTRA E MANIGLIE
KIT PLAQUE ET POIGNÉE

| | | |
|----|--------------|------|
| CC | EUA321CCNID1 | 25,9 |
| SS | EUA321SSNID1 | 32,4 |
| NP | EUA321NPNID1 | 31,1 |
| CF | EUA321CFNID1 | 38,9 |
| CS | EUA321CSNID1 | 41,5 |
| OO | EUA321OONID1 | 38,9 |
| II | EUA321IINID1 | 38,9 |
| IS | EUA321ISNID1 | 41,5 |
| RS | EUA321RSNID1 | 38,9 |
| SR | EUA321SRNID1 | 41,5 |
| OS | EUA321OSNID1 | 41,5 |
| ON | EUA321ONNID1 | 25,9 |

Marmo

RECESSED BODY
CORPO INCASSO
PARTIE ENCASTRÉ

IUA300CCXN_1 10,3

PACKAGING

L: 530 mm
D: 145 mm
H: 90 mm

4,72 kg

MARBLE

White Carrara

Black Marquina

VERTICAL | VERTICALE | VERTICAL

PLATE AND HANDLES TRIMKIT
KIT PIASTRA E MANIGLIE
KIT PLAQUE ET POIGNÉE

| | | | |
|----|--------------|--------------|------|
| CC | EUA311CCNMR1 | EUA311CCNMR2 | 32,8 |
| SS | EUA311SSNMR1 | EUA311SSNMR2 | 41,0 |
| BO | EUA311BONMR1 | EUA311BONMR2 | 39,4 |
| NP | EUA311NPNMR1 | EUA311NPNMR2 | 39,4 |
| CF | EUA311CFNMR1 | EUA311CFNMR2 | 49,3 |
| CS | EUA311CSNMR1 | EUA311CSNMR2 | 52,5 |
| OO | EUA311OONMR1 | EUA311OONMR2 | 49,3 |
| II | EUA311IINMR1 | EUA311IINMR2 | 49,3 |
| IS | EUA311ISNMR1 | EUA311ISNMR2 | 52,5 |
| RS | EUA311RSNMR1 | EUA311RSNMR2 | 49,3 |
| SR | EUA311SRNMR1 | EUA311SRNMR2 | 52,5 |
| OS | EUA311OSNMR1 | EUA311OSNMR2 | 52,5 |
| ON | EUA311ONNMR1 | EUA311PLNMR2 | 32,8 |
| PL | EUA311PLNMR1 | EUA311PLNMR2 | 52,5 |

HORIZONTAL | ORIZZONTALE | HORIZONTAL

PLATE AND HANDLES TRIMKIT
KIT PIASTRA E MANIGLIE
KIT PLAQUE ET POIGNÉE

| | | | |
|----|--------------|--------------|------|
| CC | EUA321CCNMR1 | EUA321CCNMR2 | 32,8 |
| SS | EUA321SSNMR1 | EUA321SSNMR2 | 41,0 |
| BO | EUA321BONMR1 | EUA321BONMR2 | 39,4 |
| NP | EUA321NPNMR1 | EUA321NPNMR2 | 39,4 |
| CF | EUA321CFNMR1 | EUA321CFNMR2 | 49,3 |
| CS | EUA321CSNMR1 | EUA321CSNMR2 | 52,5 |
| OO | EUA321OONMR1 | EUA321OONMR2 | 49,3 |
| II | EUA321IINMR1 | EUA321IINMR2 | 49,3 |
| IS | EUA321ISNMR1 | EUA321ISNMR2 | 52,5 |
| RS | EUA321RSNMR1 | EUA321RSNMR2 | 49,3 |
| SR | EUA321SRNMR1 | EUA321SRNMR2 | 52,5 |
| OS | EUA321OSNMR1 | EUA321OSNMR2 | 52,5 |
| ON | EUA321ONNMR1 | EUA321PLNMR2 | 32,8 |
| PL | EUA321PLNMR1 | EUA321PLNMR2 | 52,5 |

Hermes

RECESSED BODY
CORPO INCASSO
PARTIE ENCASTRÉ

IUA300CCXN_1 10,3

PACKAGING

L: 530 mm
D: 145 mm
H: 90 mm

4,56 kg

VERTICAL | VERTICALE | VERTICAL

PLATE AND HANDLES TRIMKIT
KIT PIASTRA E MANIGLIE
KIT PLAQUE ET POIGNÉE

| | | |
|----|-------------|------|
| CC | EUA315CCNHR | 26,3 |
| SS | EUA315SSNHR | 32,8 |
| II | EUA315IINHR | 39,4 |
| RS | EUA315RSNHR | 39,4 |
| OS | EUA315OSNHR | 42,0 |
| RR | EUA315RRNHR | 36,8 |
| BB | EUA315BBNHR | 36,8 |
| PL | EUA315PLNHR | 42,0 |

HORIZONTAL | ORIZZONTALE | HORIZONTAL

PLATE AND HANDLES TRIMKIT
KIT PIASTRA E MANIGLIE
KIT PLAQUE ET POIGNÉE

| | | |
|----|-------------|------|
| CC | EUA325CCNHR | 26,3 |
| SS | EUA325SSNHR | 32,8 |
| II | EUA325IINHR | 39,4 |
| RS | EUA325RSNHR | 39,4 |
| OS | EUA325OSNHR | 42,0 |
| RR | EUA325RRNHR | 36,8 |
| BB | EUA325BBNHR | 36,8 |
| PL | EUA325PLNHR | 42,0 |

Birkin

RECESSED BODY
CORPO INCASSO
PARTIE ENCASTRÉ

IUA300CCXN_1 10,3

PACKAGING

L: 530 mm
D: 145 mm
H: 90 mm

4,56 kg

VERTICAL | VERTICALE | VERTICAL

PLATE AND HANDLES TRIMKIT
KIT PIASTRA E MANIGLIE
KIT PLAQUE ET POIGNÉE

| | | |
|----|--------------|------|
| CC | EUA315CCNBR3 | 36,0 |
| SS | EUA315SSNBR3 | 45,0 |
| RS | EUA315RSNBR3 | 54,0 |
| OS | EUA315OSNBR3 | 57,6 |
| PL | EUA315PLNBR3 | 57,6 |

HORIZONTAL | ORIZZONTALE | HORIZONTAL

PLATE AND HANDLES TRIMKIT
KIT PIASTRA E MANIGLIE
KIT PLAQUE ET POIGNÉE

| | | |
|----|--------------|------|
| CC | EUA325CCNBR3 | 36,0 |
| SS | EUA325SSNBR3 | 45,0 |
| RS | EUA325RSNBR3 | 54,0 |
| OS | EUA325OSNBR3 | 57,6 |
| PL | EUA325PLNBR3 | 57,6 |

Aqua

AQUA

Thermostatic 4 ways

Termostatico 4 vie
Thermostatique 4 voies

ARTICLE | ARTICOLO | ARTICLE

IUA400CCXN_1

Only the built-in 1½" thermostatic unit of compact size, horizontal / vertical installation
Solo parte incasso termostatico 1/2 " ingombro ridotto, installazione orizzontale / verticale.
Seulement partie encastré du thermostatique 1/2" économie d'espace, installation horizontale / vertical.

CODE / COEFFICIENT | CODICE / COEFFICIENTE | CODE / COEFFICIENT

12,4

TECHNICAL DATA

Minimum dynamic pressure 0,5 bar
Maximum operational pressure 5 bar
Recommended operational pressure da 1 a 5 bar
Maximum hot water temperature 80°C

GENERAL FEATURES

Installation depth from 80 mm to 90 mm.
The intakes are fitted with G1/2" female G3/4" Male female threaded connection, the outlets only G1/2"F (1, 2 or 3 way).
The temperature regulator lever is pre-set at 38°C.
Use of a pressure reducer is recommended if pressures in the system exceed 5 bar.

DATI TECNICI

Pressione dinamica minima 0,5 bar
Pressione di esercizio massima 5 bar
Pressione di utilizzo raccomandata da 1 a 5 bar
Temperatura massima acqua calda 80°C

CARATTERISTICHE GENERALI

Profondità di installazione da 80 mm a 90 mm.
Le entrate vengono fornite con filetto G1/2" femmina G3/4" maschio, le uscite solo G1/2"F (1, 2 o 3 vie).
La maniglia di regolazione temperatura, viene presettata a 38°C.
Si raccomanda l'utilizzo di un riduttore di pressione, se all'interno dell'impianto, si hanno pressioni superiori a 5 bar.

DONNÉES TECHNIQUES

Pression dynamique minimum 0,5 bar
Pression de service maximale de 5 bar
Pression d'utilisation conseillé de 1 à 5 bar
Température maximale de l'eau chaude 80 ° C

CARACTERISTIQUES GENERALES

Profondeur de montage de 80 mm à 90 mm.
Les entrées sont fournis avec filetage G1/2" femelle G3/4" mâle, les sorties G1/2"F (1,2,ou 3 voies).
La poignée de réglage de la température, est pré-réglée à 38 ° C Si à l'intérieur du système vous avez des pressions supérieures à 5 bars, il est recommandé l'utilisation d'un réducteur de pression..

Built-in part - Parte incasso - Corps encastré

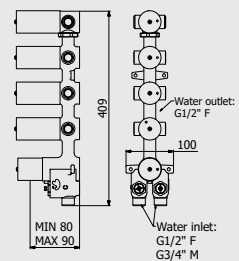

Plate and handles - Parte esterna - Plaque et poignée

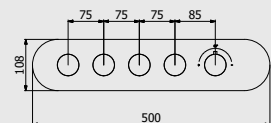
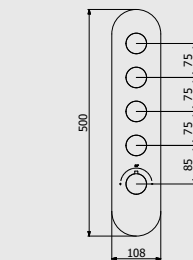

Plate and handles - Parte esterna - Plaque et poignée



PACKAGING

L: 440 mm D: 190 mm H: 165 mm 5,4 kg

ORIENTATION | ORIENTAZIONE | ORIENTATION

2 ways to Installation: horizontal or vertical
2 modalità di installazione: verticale o orizzontale
2 modalitè de installation: vertical ou horizontal.

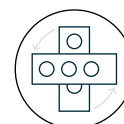

FOR ALL MODELS
PER TUTTI I MODELLI
POUR TOUS LES MODÈLES



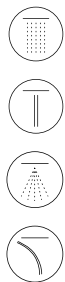
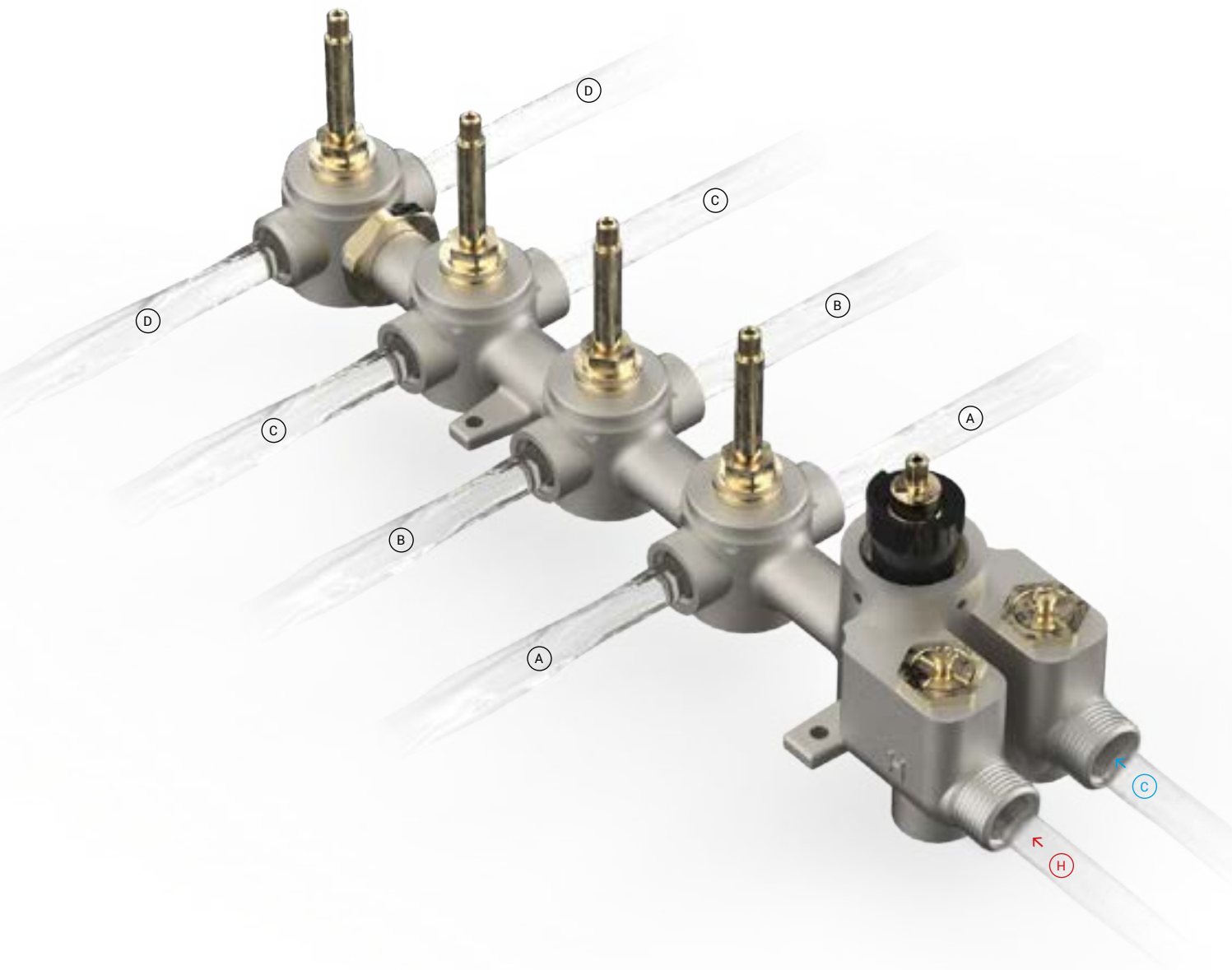

- A **Mixed water outlet**
Uscita acqua miscelata
Sortie eau mélangé
- B **Mixed water outlet**
Uscita acqua miscelata
Sortie eau mélangé
- C **Mixed water outlet**
Uscita acqua miscelata
Sortie eau mélangé
- D **Mixed water outlet**
Uscita acqua miscelata
Sortie eau mélangé

- H** **Hot water**
Acqua calda
Eau chaude
- C** **Cold water**
Acqua fredda
Eau froide

Aqua

PORTATE | WATER FLOW | DÉBIT D'EAU

| 0.2 BAR | 0.5 BAR | 1 BAR | 2 BAR | 3 BAR | 4 BAR | 5 BAR |
|----------|---------|--------|--------|--------|--------|--------|
| 10,7 l/m | 18 l/m | 26 l/m | 37 l/m | 45 l/m | 51 l/m | 56 l/m |

Hey Joe!



RECESSED BODY
CORPO INCASSO
PARTIE ENCASTRÉ
IUA400CCXN_1 12,4

PACKAGING

L: 530 mm
D: 145 mm
H: 90 mm

4,86 kg



VERTICAL | VERTICALE | VERTICAL

PLATE AND HANDLES TRIMKIT
KIT PIASTRA E MANIGLIE
KIT PLAQUE ET POIGNÉE



| | | |
|----|-------------|------|
| CC | EUA412CCNHJ | 32,1 |
| SS | EUA412SSNHJ | 40,2 |
| BO | EUA412BONHJ | 38,6 |
| NP | EUA412NPNHJ | 38,6 |
| CF | EUA412CFNHJ | 48,2 |
| CS | EUA412CSNHJ | 51,4 |
| OO | EUA412OONHJ | 48,2 |
| II | EUA412IINHJ | 48,2 |
| IS | EUA412ISNHJ | 51,4 |
| RS | EUA412RSNHJ | 48,2 |
| SR | EUA412SRNHJ | 51,4 |
| OS | EUA412OSNHJ | 51,4 |

HORIZONTAL | ORIZZONTALE | HORIZONTAL

PLATE AND HANDLES TRIMKIT
KIT PIASTRA E MANIGLIE
KIT PLAQUE ET POIGNÉE



| | | |
|----|-------------|------|
| CC | EUA422CCNHJ | 32,1 |
| SS | EUA422SSNHJ | 40,2 |
| BO | EUA422BONHJ | 38,6 |
| NP | EUA422NPNHJ | 38,6 |
| CF | EUA422CFNHJ | 48,2 |
| CS | EUA422CSNHJ | 51,4 |
| OO | EUA422OONHJ | 48,2 |
| II | EUA422IINHJ | 48,2 |
| IS | EUA422ISNHJ | 51,4 |
| RS | EUA422RSNHJ | 48,2 |
| SR | EUA422SRNHJ | 51,4 |
| OS | EUA422OSNHJ | 51,4 |

Loveme



RECESSED BODY
CORPO INCASSO
PARTIE ENCASTRÉ
IUA400CCXN_1 12,4

PACKAGING

L: 530 mm
D: 145 mm
H: 90 mm

4,86 kg



VERTICAL | VERTICALE | VERTICAL

PLATE AND HANDLES TRIMKIT
KIT PIASTRA E MANIGLIE
KIT PLAQUE ET POIGNÉE



| | | |
|----|-------------|------|
| CC | EUA412CCNLM | 32,1 |
| SS | EUA412SSNLM | 40,2 |
| BO | EUA412BONLM | 38,6 |
| NP | EUA412NPNLM | 38,6 |
| CS | EUA412CSNLM | 51,4 |
| IS | EUA412ISNLM | 51,4 |
| SR | EUA412SRNLM | 51,4 |
| OS | EUA412OSNLM | 51,4 |
| ON | EUA412ONNLM | 32,1 |

HORIZONTAL | ORIZZONTALE | HORIZONTAL

PLATE AND HANDLES TRIMKIT
KIT PIASTRA E MANIGLIE
KIT PLAQUE ET POIGNÉE



| | | |
|----|-------------|------|
| CC | EUA422CCNLM | 32,1 |
| SS | EUA422SSNLM | 40,2 |
| BO | EUA422BONLM | 38,6 |
| NP | EUA422NPNLM | 38,6 |
| CS | EUA422CSNLM | 51,4 |
| IS | EUA422ISNLM | 51,4 |
| SR | EUA422SRNLM | 51,4 |
| OS | EUA422OSNLM | 51,4 |
| ON | EUA422ONNLM | 32,1 |

Belmondo



RECESSED BODY
CORPO INCASSO
PARTIE ENCASTRÉ
IUA400CCXN_1 12,4

PACKAGING

L: 530 mm
D: 145 mm
H: 90 mm

4,86 kg



VERTICAL | VERTICALE | VERTICAL

PLATE AND HANDLES TRIMKIT
KIT PIASTRA E MANIGLIE
KIT PLAQUE ET POIGNÉE



| | | |
|----|-------------|------|
| CC | EUA412CCNBT | 32,1 |
| OO | EUA412OONBT | 48,2 |
| II | EUA412IINBT | 48,2 |
| RS | EUA412RSNBT | 48,2 |
| PL | EUA412PLNBT | 51,4 |

HORIZONTAL | ORIZZONTALE | HORIZONTAL

PLATE AND HANDLES TRIMKIT
KIT PIASTRA E MANIGLIE
KIT PLAQUE ET POIGNÉE



| | | |
|----|-------------|------|
| CC | EUA422CCNBT | 32,1 |
| OO | EUA422OONBT | 48,2 |
| II | EUA422IINBT | 48,2 |
| RS | EUA422RSNBT | 48,2 |
| PL | EUA422PLNBT | 51,4 |

Batlò



RECESSED BODY
CORPO INCASSO
PARTIE ENCASTRÉ
IUA400CCXN_1 12,4

PACKAGING

L: 530 mm
D: 145 mm
H: 90 mm

4,86 kg



VERTICAL | VERTICALE | VERTICAL

PLATE AND HANDLES TRIMKIT
KIT PIASTRA E MANIGLIE
KIT PLAQUE ET POIGNÉE



| | | |
|----|-------------|------|
| CC | EUA412CCNBI | 32,1 |
| SS | EUA412SSNBI | 40,2 |
| BO | EUA412BONBI | 38,6 |
| NP | EUA412NPNBI | 38,6 |
| CF | EUA412CFNBI | 48,2 |
| CS | EUA412CSNBI | 51,4 |
| OO | EUA412OONBI | 48,2 |
| II | EUA412IINBI | 48,2 |
| IS | EUA412ISNBI | 51,4 |
| RS | EUA412RSNBI | 48,2 |
| SR | EUA412SRNBI | 51,4 |
| OS | EUA412OSNBI | 51,4 |

HORIZONTAL | ORIZZONTALE | HORIZONTAL

PLATE AND HANDLES TRIMKIT
KIT PIASTRA E MANIGLIE
KIT PLAQUE ET POIGNÉE



| | | |
|----|-------------|------|
| CC | EUA422CCNBI | 32,1 |
| SS | EUA422SSNBI | 40,2 |
| BO | EUA422BONBI | 38,6 |
| NP | EUA422NPNBI | 38,6 |
| CF | EUA422CFNBI | 48,2 |
| CS | EUA422CSNBI | 51,4 |
| OO | EUA422OONBI | 48,2 |
| II | EUA422IINBI | 48,2 |
| IS | EUA422ISNBI | 51,4 |
| RS | EUA422RSNBI | 48,2 |
| SR | EUA422SRNBI | 51,4 |
| OS | EUA422OSNBI | 51,4 |

Kusasi



RECESSED BODY
CORPO INCASSO
PARTIE ENCASTRÉ
IUA400CCXN_1 12,4

PACKAGING

L: 530 mm
D: 145 mm
H: 90 mm

4,86 kg



VERTICAL | VERTICALE | VERTICAL

PLATE AND HANDLES TRIMKIT
KIT PIASTRA E MANIGLIE
KIT PLAQUE ET POIGNÉE



| | | |
|----|-------------|------|
| CC | EUA412CCNKU | 32,1 |
| SS | EUA412SSNKU | 40,2 |
| NP | EUA412NPNKU | 38,6 |

HORIZONTAL | ORIZZONTALE | HORIZONTAL

PLATE AND HANDLES TRIMKIT
KIT PIASTRA E MANIGLIE
KIT PLAQUE ET POIGNÉE



| | | |
|----|-------------|------|
| CC | EUA422CCNKU | 32,1 |
| SS | EUA422SSNKU | 40,2 |
| NP | EUA422NPNKU | 38,6 |

Wow



RECESSED BODY
CORPO INCASSO
PARTIE ENCASTRÉ

IUA400CCXN_1 12,4

PACKAGING

L: 530 mm
D: 145 mm
H: 90 mm

4,86 kg

VERTICAL | VERTICALE | VERTICAL

PLATE AND HANDLES TRIMKIT
KIT PIASTRA E MANIGLIE
KIT PLAQUE ET POIGNÉE

| | | |
|----|-------------|------|
| CC | EUA412CCNWO | 32,1 |
| SS | EUA412SSNWO | 40,2 |
| BO | EUA412BONWO | 38,6 |
| NP | EUA412NPNWO | 38,6 |
| OO | EUA412OONWO | 48,2 |

HORIZONTAL | ORIZZONTALE | HORIZONTAL

PLATE AND HANDLES TRIMKIT
KIT PIASTRA E MANIGLIE
KIT PLAQUE ET POIGNÉE

| | | |
|----|-------------|------|
| CC | EUA422CCNWO | 32,1 |
| SS | EUA422SSNWO | 40,2 |
| BO | EUA422BONWO | 38,6 |
| NP | EUA422NPNWO | 38,6 |
| OO | EUA422OONWO | 48,2 |

Industria



RECESSED BODY
CORPO INCASSO
PARTIE ENCASTRÉ

IUA400CCXN_1 12,4

PACKAGING

L: 530 mm
D: 145 mm
H: 90 mm

4,86 kg

VERTICAL | VERTICALE | VERTICAL

PLATE AND HANDLES TRIMKIT
KIT PIASTRA E MANIGLIE
KIT PLAQUE ET POIGNÉE

| | | |
|----|--------------|------|
| CC | EUA412CCNID1 | 32,1 |
| SS | EUA412SSNID1 | 40,2 |
| NP | EUA412NPNID1 | 38,6 |
| CF | EUA412CFNID1 | 48,2 |
| CS | EUA412CSNID1 | 51,4 |
| OO | EUA412OONID1 | 48,2 |
| II | EUA412IINID1 | 48,2 |
| IS | EUA412ISNID1 | 51,4 |
| RS | EUA412RSNID1 | 48,2 |
| SR | EUA412SRNID1 | 51,4 |
| OS | EUA412OSNID1 | 51,4 |
| ON | EUA412ONNID1 | 32,1 |

HORIZONTAL | ORIZZONTALE | HORIZONTAL

PLATE AND HANDLES TRIMKIT
KIT PIASTRA E MANIGLIE
KIT PLAQUE ET POIGNÉE

| | | |
|----|--------------|------|
| CC | EUA422CCNID1 | 32,1 |
| SS | EUA422SSNID1 | 40,2 |
| NP | EUA422NPNID1 | 38,6 |
| CF | EUA422CFNID1 | 48,2 |
| CS | EUA422CSNID1 | 51,4 |
| OO | EUA422OONID1 | 48,2 |
| II | EUA422IINID1 | 48,2 |
| IS | EUA422ISNID1 | 51,4 |
| RS | EUA422RSNID1 | 48,2 |
| SR | EUA422SRNID1 | 51,4 |
| OS | EUA422OSNID1 | 51,4 |
| ON | EUA422ONNID1 | 32,1 |

Bold



RECESSED BODY
CORPO INCASSO
PARTIE ENCASTRÉ

IUA400CCXN_1 12,4

PACKAGING

L: 530 mm
D: 145 mm
H: 90 mm

4,86 kg

VERTICAL | VERTICALE | VERTICAL

PLATE AND HANDLES TRIMKIT
KIT PIASTRA E MANIGLIE
KIT PLAQUE ET POIGNÉE

| | | |
|----|-------------|------|
| CC | EUA412CCNB1 | 34,6 |
| SS | EUA412SSNB1 | 43,3 |
| NP | EUA412NPNB1 | 41,6 |
| CF | EUA412CFNB1 | 52,0 |
| CS | EUA412CSNB1 | 55,4 |
| OO | EUA412OONB1 | 52,0 |
| II | EUA412IINB1 | 52,0 |
| IS | EUA412ISNB1 | 55,4 |
| RS | EUA412RSNB1 | 52,0 |
| SR | EUA412SRNB1 | 55,4 |
| OS | EUA412OSNB1 | 55,4 |
| ON | EUA412ONNB1 | 34,6 |

HORIZONTAL | ORIZZONTALE | HORIZONTAL

PLATE AND HANDLES TRIMKIT
KIT PIASTRA E MANIGLIE
KIT PLAQUE ET POIGNÉE

| | | |
|----|-------------|------|
| CC | EUA422CCNB1 | 34,6 |
| SS | EUA422SSNB1 | 43,3 |
| NP | EUA422NPNB1 | 41,6 |
| CF | EUA422CFNB1 | 52,0 |
| CS | EUA422CSNB1 | 55,4 |
| OO | EUA422OONB1 | 52,0 |
| II | EUA422IINB1 | 52,0 |
| IS | EUA422ISNB1 | 55,4 |
| RS | EUA422RSNB1 | 52,0 |
| SR | EUA422SRNB1 | 55,4 |
| OS | EUA422OSNB1 | 55,4 |
| ON | EUA422ONNB1 | 34,6 |

Birkin



RECESSED BODY
CORPO INCASSO
PARTIE ENCASTRÉ

IUA400CCXN_1 12,4

PACKAGING

L: 530 mm
D: 145 mm
H: 90 mm

4,86 kg

VERTICAL | VERTICALE | VERTICAL

PLATE AND HANDLES TRIMKIT
KIT PIASTRA E MANIGLIE
KIT PLAQUE ET POIGNÉE

| | | |
|----|--------------|------|
| CC | EUA412CCNBR3 | 44,7 |
| SS | EUA412SSNBR3 | 55,9 |
| RS | EUA412RSNBR3 | 67,0 |
| OS | EUA412OSNBR3 | 71,5 |
| PL | EUA412PLNBR3 | 71,5 |

HORIZONTAL | ORIZZONTALE | HORIZONTAL

PLATE AND HANDLES TRIMKIT
KIT PIASTRA E MANIGLIE
KIT PLAQUE ET POIGNÉE

| | | |
|----|--------------|------|
| CC | EUA422CCNBR3 | 44,7 |
| SS | EUA422SSNBR3 | 55,9 |
| RS | EUA422RSNBR3 | 67,0 |
| OS | EUA422OSNBR3 | 71,5 |
| PL | EUA422PLNBR3 | 71,5 |

Marmo



RECESSED BODY
CORPO INCASSO
PARTIE ENCASTRÉ

IUA400CCXN_1 12,4

PACKAGING

L: 530 mm
D: 145 mm
H: 90 mm

5,06 kg

MARBLE

White Carrara

Black Marquina

VERTICAL | VERTICALE | VERTICAL

PLATE AND HANDLES TRIMKIT
KIT PIASTRA E MANIGLIE
KIT PLAQUE ET POIGNÉE

| | | | |
|----|--------------|--------------|------|
| CC | EUA412CCNMR1 | EUA412CCNMR2 | 40,8 |
| SS | EUA412SSNMR1 | EUA412SSNMR2 | 51,0 |
| BO | EUA412BONMR1 | EUA412BONMR2 | 48,9 |
| NP | EUA412NPNMR1 | EUA412NPNMR2 | 48,9 |
| CF | EUA412CFNMR1 | EUA412CFNMR2 | 61,1 |
| CS | EUA412CSNMR1 | EUA412CSNMR2 | 65,2 |
| OO | EUA412OONMR1 | EUA412OONMR2 | 61,1 |
| II | EUA412IINMR1 | EUA412IINMR2 | 61,1 |
| IS | EUA412ISNMR1 | EUA412ISNMR2 | 65,2 |
| RS | EUA412RSNMR1 | EUA412RSNMR2 | 61,1 |
| SR | EUA412SRNMR1 | EUA412SRNMR2 | 65,2 |
| OS | EUA412OSNMR1 | EUA412OSNMR2 | 65,2 |
| ON | EUA412ONNMR1 | EUA412PLNMR2 | 40,8 |
| PL | EUA412PLNMR1 | EUA412PLNMR2 | 65,2 |

HORIZONTAL | ORIZZONTALE | HORIZONTAL

PLATE AND HANDLES TRIMKIT
KIT PIASTRA E MANIGLIE
KIT PLAQUE ET POIGNÉE

| | | | |
|----|--------------|--------------|------|
| CC | EUA422CCNMR1 | EUA422CCNMR2 | 40,8 |
| SS | EUA422SSNMR1 | EUA422SSNMR2 | 51,0 |
| BO | EUA422BONMR1 | EUA422BONMR2 | 48,9 |
| NP | EUA422NPNMR1 | EUA422NPNMR2 | 48,9 |
| CF | EUA422CFNMR1 | EUA422CFNMR2 | 61,1 |
| CS | EUA422CSNMR1 | EUA422CSNMR2 | 65,2 |
| OO | EUA422OONMR1 | EUA422OONMR2 | 61,1 |
| II | EUA422IINMR1 | EUA422IINMR2 | 61,1 |
| IS | EUA422ISNMR1 | EUA422ISNMR2 | 65,2 |
| RS | EUA422RSNMR1 | EUA422RSNMR2 | 61,1 |
| SR | EUA422SRNMR1 | EUA422SRNMR2 | 65,2 |
| OS | EUA422OSNMR1 | EUA422OSNMR2 | 65,2 |
| ON | EUA422ONNMR1 | EUA422PLNMR2 | 40,8 |
| PL | EUA422PLNMR1 | EUA422PLNMR2 | 65,2 |

Aqua

Rubacuori



RECESSED BODY
CORPO INCASSO
PARTIE ENCASTRÉ
IUA400CCXN_1 12,4

PACKAGING

L: 530 mm
D: 145 mm
H: 90 mm

4,86 kg



VERTICAL | VERTICALE | VERTICAL

PLATE AND HANDLES TRIMKIT
KIT PIASTRÀ E MANIGLIE
KIT PLAQUE ET POIGNÉE

| | | |
|----|-------------|------|
| CC | EUA411CCNRU | 32,1 |
| SS | EUA411SSNRU | 40,2 |
| BO | EUA411BONRU | 38,6 |
| NP | EUA411NPNRU | 38,6 |
| CF | EUA411CFNRU | 48,2 |
| CS | EUA411CSNRU | 51,4 |
| OO | EUA411OONRU | 48,2 |
| II | EUA411IINRU | 48,2 |
| IS | EUA411ISNRU | 51,4 |
| RS | EUA411RSNRU | 48,2 |
| SR | EUA411SRNRU | 51,4 |
| OS | EUA411OSNRU | 51,4 |

HORIZONTAL | ORIZZONTALE | HORIZONTAL

PLATE AND HANDLES TRIMKIT
KIT PIASTRÀ E MANIGLIE
KIT PLAQUE ET POIGNÉE

| | | |
|----|-------------|------|
| CC | EUA421CCNRU | 32,1 |
| SS | EUA421SSNRU | 40,2 |
| BO | EUA421BONRU | 38,6 |
| NP | EUA421NPNRU | 38,6 |
| CF | EUA421CFNRU | 48,2 |
| CS | EUA421CSNRU | 51,4 |
| OO | EUA421OONRU | 48,2 |
| II | EUA421IINRU | 48,2 |
| IS | EUA421ISNRU | 51,4 |
| RS | EUA421RSNRU | 48,2 |
| SR | EUA421SRNRU | 51,4 |
| OS | EUA421OSNRU | 51,4 |

Hey joe!



RECESSED BODY
CORPO INCASSO
PARTIE ENCASTRÉ
IUA400CCXN_1 12,4

PACKAGING

L: 530 mm
D: 145 mm
H: 90 mm

4,86 kg



VERTICAL | VERTICALE | VERTICAL

PLATE AND HANDLES TRIMKIT
KIT PIASTRÀ E MANIGLIE
KIT PLAQUE ET POIGNÉE

| | | |
|----|-------------|------|
| CC | EUA411CCNHJ | 32,1 |
| SS | EUA411SSNHJ | 40,2 |
| BO | EUA411BONHJ | 38,6 |
| NP | EUA411NPNHJ | 38,6 |
| CF | EUA411CFNHJ | 48,2 |
| CS | EUA411CSNHJ | 51,4 |
| OO | EUA411OONHJ | 48,2 |
| II | EUA411IINHJ | 48,2 |
| IS | EUA411ISNHJ | 51,4 |
| RS | EUA411RSNHJ | 48,2 |
| SR | EUA411SRNHJ | 51,4 |
| OS | EUA411OSNHJ | 51,4 |

HORIZONTAL | ORIZZONTALE | HORIZONTAL

PLATE AND HANDLES TRIMKIT
KIT PIASTRÀ E MANIGLIE
KIT PLAQUE ET POIGNÉE

| | | |
|----|-------------|------|
| CC | EUA421CCNHJ | 32,1 |
| SS | EUA421SSNHJ | 40,2 |
| BO | EUA421BONHJ | 38,6 |
| NP | EUA421NPNHJ | 38,6 |
| CF | EUA421CFNHJ | 48,2 |
| CS | EUA421CSNHJ | 51,4 |
| OO | EUA421OONHJ | 48,2 |
| II | EUA421IINHJ | 48,2 |
| IS | EUA421ISNHJ | 51,4 |
| RS | EUA421RSNHJ | 48,2 |
| SR | EUA421SRNHJ | 51,4 |
| OS | EUA421OSNHJ | 51,4 |

Belmondo



RECESSED BODY
CORPO INCASSO
PARTIE ENCASTRÉ
IUA400CCXN_1 12,4

PACKAGING

L: 530 mm
D: 145 mm
H: 90 mm

4,86 kg



VERTICAL | VERTICALE | VERTICAL

PLATE AND HANDLES TRIMKIT
KIT PIASTRÀ E MANIGLIE
KIT PLAQUE ET POIGNÉE

| | | |
|----|-------------|------|
| CC | EUA411CCNBT | 32,1 |
| OO | EUA411OONBT | 48,2 |
| II | EUA411IINBT | 48,2 |
| RS | EUA411RSNBT | 48,2 |
| PL | EUA411PLNBT | 51,4 |

HORIZONTAL | ORIZZONTALE | HORIZONTAL

PLATE AND HANDLES TRIMKIT
KIT PIASTRÀ E MANIGLIE
KIT PLAQUE ET POIGNÉE

| | | |
|----|-------------|------|
| CC | EUA421CCNBT | 32,1 |
| OO | EUA421OONBT | 48,2 |
| II | EUA421IINBT | 48,2 |
| RS | EUA421RSNBT | 48,2 |
| PL | EUA421PLNBT | 51,4 |

Kusasi



RECESSED BODY
CORPO INCASSO
PARTIE ENCASTRÉ
IUA400CCXN_1 12,4

PACKAGING

L: 530 mm
D: 145 mm
H: 90 mm

4,86 kg



VERTICAL | VERTICALE | VERTICAL

PLATE AND HANDLES TRIMKIT
KIT PIASTRÀ E MANIGLIE
KIT PLAQUE ET POIGNÉE

| | | |
|----|-------------|------|
| CC | EUA411CCNKU | 32,1 |
| SS | EUA411SSNKU | 40,2 |
| NP | EUA411NPNKU | 38,6 |

HORIZONTAL | ORIZZONTALE | HORIZONTAL

PLATE AND HANDLES TRIMKIT
KIT PIASTRÀ E MANIGLIE
KIT PLAQUE ET POIGNÉE

| | | |
|----|-------------|------|
| CC | EUA421CCNKU | 32,1 |
| SS | EUA421SSNKU | 40,2 |
| NP | EUA421NPNKU | 38,6 |

Wow



RECESSED BODY
CORPO INCASSO
PARTIE ENCASTRÉ
IUA400CCXN_1 12,4

PACKAGING

L: 530 mm
D: 145 mm
H: 90 mm

4,86 kg



VERTICAL | VERTICALE | VERTICAL

PLATE AND HANDLES TRIMKIT
KIT PIASTRÀ E MANIGLIE
KIT PLAQUE ET POIGNÉE

| | | |
|----|-------------|------|
| CC | EUA411CCNWO | 32,1 |
| SS | EUA411SSNWO | 40,2 |
| BO | EUA411BONWO | 38,6 |
| NP | EUA411NPNWO | 38,6 |
| OO | EUA411OONWO | 48,2 |

HORIZONTAL | ORIZZONTALE | HORIZONTAL

PLATE AND HANDLES TRIMKIT
KIT PIASTRÀ E MANIGLIE
KIT PLAQUE ET POIGNÉE

| | | |
|----|-------------|------|
| CC | EUA421CCNWO | 32,1 |
| SS | EUA421SSNWO | 40,2 |
| BO | EUA421BONWO | 38,6 |
| NP | EUA421NPNWO | 38,6 |
| OO | EUA421OONWO | 48,2 |



Industria

RECESSED BODY
CORPO INCASSO
PARTIE ENCASTRÉ

IUA400CCXN_1 12,4

PACKAGING

L: 530 mm
D: 145 mm
H: 90 mm

4,86 kg

VERTICAL | VERTICALE | VERTICAL

PLATE AND HANDLES TRIMKIT
KIT PIASTRA E MANIGLIE
KIT PLAQUE ET POIGNÉE

| | | |
|----|--------------|------|
| CC | EUA411CCNID1 | 32,1 |
| SS | EUA411SSNID1 | 40,2 |
| NP | EUA411NPNID1 | 38,6 |
| CF | EUA411CFNID1 | 48,2 |
| CS | EUA411CSNID1 | 51,4 |
| OO | EUA411OONID1 | 48,2 |
| II | EUA411IINID1 | 48,2 |
| IS | EUA411ISNID1 | 51,4 |
| RS | EUA411RSNID1 | 48,2 |
| SR | EUA411SRNID1 | 51,4 |
| OS | EUA411OSNID1 | 51,4 |
| ON | EUA411ONNID1 | 32,1 |

HORIZONTAL | ORIZZONTALE | HORIZONTAL

PLATE AND HANDLES TRIMKIT
KIT PIASTRA E MANIGLIE
KIT PLAQUE ET POIGNÉE

| | | |
|----|--------------|------|
| CC | EUA421CCNID1 | 32,1 |
| SS | EUA421SSNID1 | 40,2 |
| NP | EUA421NPNID1 | 38,6 |
| CF | EUA421CFNID1 | 48,2 |
| CS | EUA421CSNID1 | 51,4 |
| OO | EUA421OONID1 | 48,2 |
| II | EUA421IINID1 | 48,2 |
| IS | EUA421ISNID1 | 51,4 |
| RS | EUA421RSNID1 | 48,2 |
| SR | EUA421SRNID1 | 51,4 |
| OS | EUA421OSNID1 | 51,4 |
| ON | EUA421ONNID1 | 32,1 |

Marmo

RECESSED BODY
CORPO INCASSO
PARTIE ENCASTRÉ

IUA400CCXN_1 12,4

PACKAGING

L: 530 mm
D: 145 mm
H: 90 mm

5,06 kg

MARBLE

White Carrara

Black Marquina

VERTICAL | VERTICALE | VERTICAL

PLATE AND HANDLES TRIMKIT
KIT PIASTRA E MANIGLIE
KIT PLAQUE ET POIGNÉE

| | | | |
|----|--------------|--------------|------|
| CC | EUA411CCNMR1 | EUA411CCNMR2 | 40,8 |
| SS | EUA411SSNMR1 | EUA411SSNMR2 | 51,0 |
| BO | EUA411BONMR1 | EUA411BONMR2 | 48,9 |
| NP | EUA411NPNMR1 | EUA411NPNMR2 | 48,9 |
| CF | EUA411CFNMR1 | EUA411CFNMR2 | 61,1 |
| CS | EUA411CSNMR1 | EUA411CSNMR2 | 65,2 |
| OO | EUA411OONMR1 | EUA411OONMR2 | 61,1 |
| II | EUA411IINMR1 | EUA411IINMR2 | 61,1 |
| IS | EUA411ISNMR1 | EUA411ISNMR2 | 65,2 |
| RS | EUA411RSNMR1 | EUA411RSNMR2 | 61,1 |
| SR | EUA411SRNMR1 | EUA411SRNMR2 | 65,2 |
| OS | EUA411OSNMR1 | EUA411OSNMR2 | 65,2 |
| ON | EUA411ONNMR1 | EUA411PLNMR2 | 40,8 |
| PL | EUA411PLNMR1 | EUA411PLNMR2 | 65,2 |

HORIZONTAL | ORIZZONTALE | HORIZONTAL

PLATE AND HANDLES TRIMKIT
KIT PIASTRA E MANIGLIE
KIT PLAQUE ET POIGNÉE

| | | | |
|----|--------------|--------------|------|
| CC | EUA421CCNMR1 | EUA421CCNMR2 | 40,8 |
| SS | EUA421SSNMR1 | EUA421SSNMR2 | 51,0 |
| BO | EUA421BONMR1 | EUA421BONMR2 | 48,9 |
| NP | EUA421NPNMR1 | EUA421NPNMR2 | 48,9 |
| CF | EUA421CFNMR1 | EUA421CFNMR2 | 61,1 |
| CS | EUA421CSNMR1 | EUA421CSNMR2 | 65,2 |
| OO | EUA421OONMR1 | EUA421OONMR2 | 61,1 |
| II | EUA421IINMR1 | EUA421IINMR2 | 61,1 |
| IS | EUA421ISNMR1 | EUA421ISNMR2 | 65,2 |
| RS | EUA421RSNMR1 | EUA421RSNMR2 | 61,1 |
| SR | EUA421SRNMR1 | EUA421SRNMR2 | 65,2 |
| OS | EUA421OSNMR1 | EUA421OSNMR2 | 65,2 |
| ON | EUA421ONNMR1 | EUA421PLNMR2 | 40,8 |
| PL | EUA421PLNMR1 | EUA421PLNMR2 | 65,2 |

Hermes

RECESSED BODY
CORPO INCASSO
PARTIE ENCASTRÉ

IUA400CCXN_1 12,4

PACKAGING

L: 530 mm
D: 145 mm
H: 90 mm

4,86 kg

VERTICAL | VERTICALE | VERTICAL

PLATE AND HANDLES TRIMKIT
KIT PIASTRA E MANIGLIE
KIT PLAQUE ET POIGNÉE

| | | |
|----|-------------|------|
| CC | EUA415CCNHR | 32,5 |
| SS | EUA415SSNHR | 40,6 |
| II | EUA415IINHR | 48,8 |
| RS | EUA415RSNHR | 48,8 |
| OS | EUA415OSNHR | 52,0 |
| RR | EUA415RRNHR | 45,5 |
| BB | EUA415BBNHR | 45,5 |
| PL | EUA415PLNHR | 52,0 |

HORIZONTAL | ORIZZONTALE | HORIZONTAL

PLATE AND HANDLES TRIMKIT
KIT PIASTRA E MANIGLIE
KIT PLAQUE ET POIGNÉE

| | | |
|----|-------------|------|
| CC | EUA425CCNHR | 32,5 |
| SS | EUA425SSNHR | 40,6 |
| II | EUA425IINHR | 48,8 |
| RS | EUA425RSNHR | 48,8 |
| OS | EUA425OSNHR | 52,0 |
| RR | EUA425RRNHR | 45,5 |
| BB | EUA425BBNHR | 45,5 |
| PL | EUA425PLNHR | 52,0 |

Birkin

RECESSED BODY
CORPO INCASSO
PARTIE ENCASTRÉ

IUA400CCXN_1 12,4

PACKAGING

L: 530 mm
D: 145 mm
H: 90 mm

4,86 kg

VERTICAL | VERTICALE | VERTICAL

PLATE AND HANDLES TRIMKIT
KIT PIASTRA E MANIGLIE
KIT PLAQUE ET POIGNÉE

| | | |
|----|--------------|------|
| CC | EUA415CCNBR3 | 44,7 |
| SS | EUA415SSNBR3 | 55,9 |
| RS | EUA415RSNBR3 | 67,0 |
| OS | EUA415OSNBR3 | 71,5 |
| PL | EUA415PLNBR3 | 71,5 |

HORIZONTAL | ORIZZONTALE | HORIZONTAL

PLATE AND HANDLES TRIMKIT
KIT PIASTRA E MANIGLIE
KIT PLAQUE ET POIGNÉE

| | | |
|----|--------------|------|
| CC | EUA425CCNBR3 | 44,7 |
| SS | EUA425SSNBR3 | 55,9 |
| RS | EUA425RSNBR3 | 67,0 |
| OS | EUA425OSNBR3 | 71,5 |
| PL | EUA425PLNBR3 | 71,5 |

Aqua

AQUA

Thermostatic 5 ways

Termostatico 5 vie
Thermostatique 5 voies

ARTICLE | ARTICOLO | ARTICLE

IUA500CCXN_1

Only the built-in 1½" thermostatic unit of compact size, horizontal / vertical installation
Solo parte incasso termostatico 1/2 " ingombro ridotto, installazione orizzontale / verticale.
Seulement partie encastré du thermostatique 1/2" économie d'espace, installation horizontale / vertical.

CODE / COEFFICIENT | CODICE / COEFFICIENTE | CODE / COEFFICIENT

14,0

TECHNICAL DATA

Minimum dynamic pressure 0,5 bar
Maximum operational pressure 5 bar
Recommended operational pressure da 1 a 5 bar
Maximum hot water temperature 80°C

GENERAL FEATURES

Installation depth from 80 mm to 90 mm.
The intakes are fitted with G1/2" female G3/4" Male threaded connection, the outlets only G1/2"F (1, 2 or 3 way).
The temperature regulator lever is pre-set at 38°C.
Use of a pressure reducer is recommended if pressures in the system exceed 5 bar.

DATI TECNICI

Pressione dinamica minima 0,5 bar
Pressione di esercizio massima 5 bar
Pressione di utilizzo raccomandata da 1 a 5 bar
Temperatura massima acqua calda 80°C

CARATTERISTICHE GENERALI

Profondità di installazione da 80 mm a 90 mm.
Le entrate vengono fornite con filetto G1/2" femmina G3/4" maschio, le uscite solo G1/2"F (1, 2 o 3 vie).
La maniglia di regolazione temperatura, viene pre-settata a 38°C.
Si raccomanda l'utilizzo di un riduttore di pressione, se all'interno dell'impianto, si hanno pressioni superiori a 5 bar.

DONNÉES TECHNIQUES

Pression dynamique minimum 0,5 bar
Pression de service maximale de 5 bar
Pression d'utilisation conseillé de 1 à 5 bar
Température maximale de l'eau chaude 80 ° C

CARACTERISTIQUES GENERALES

rofondeur de montage de 80 mm à 90 mm.
Les entrées sont fournis avec filetage G1/2" femelle G3/4" mâle, les sorties G1/2"F (1,2,ou 3 voies).
La poignée de réglage de la température, est pré-réglée à 38 ° C Si à l'intérieur du système vous avez des pressions supérieures à 5 bars, il est recommandé l'utilisation d'un réducteur de pression..

Built-in part - Parte incasso - Corps encastré

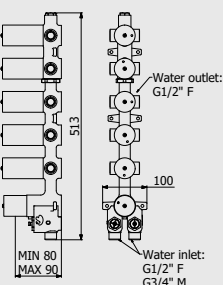

Plate and handles - Parte esterna - Plaque et poignée

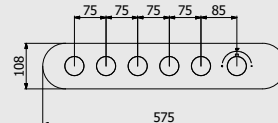
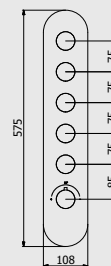

Plate and handles - Parte esterna - Plaque et poignée



PACKAGING

L: 530 mm D: 190 mm H: 165 mm 6,0 kg

ORIENTATION | ORIENTAZIONE | ORIENTATION

2 ways to installation: horizontal or vertical
2 modalità di installazione: verticale o orizzontale
2 modalités de installation: vertical ou horizontal.

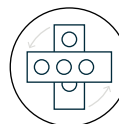

FOR ALL MODELS
PER TUTTI I MODELLI
POUR TOUS LES MODÈLES



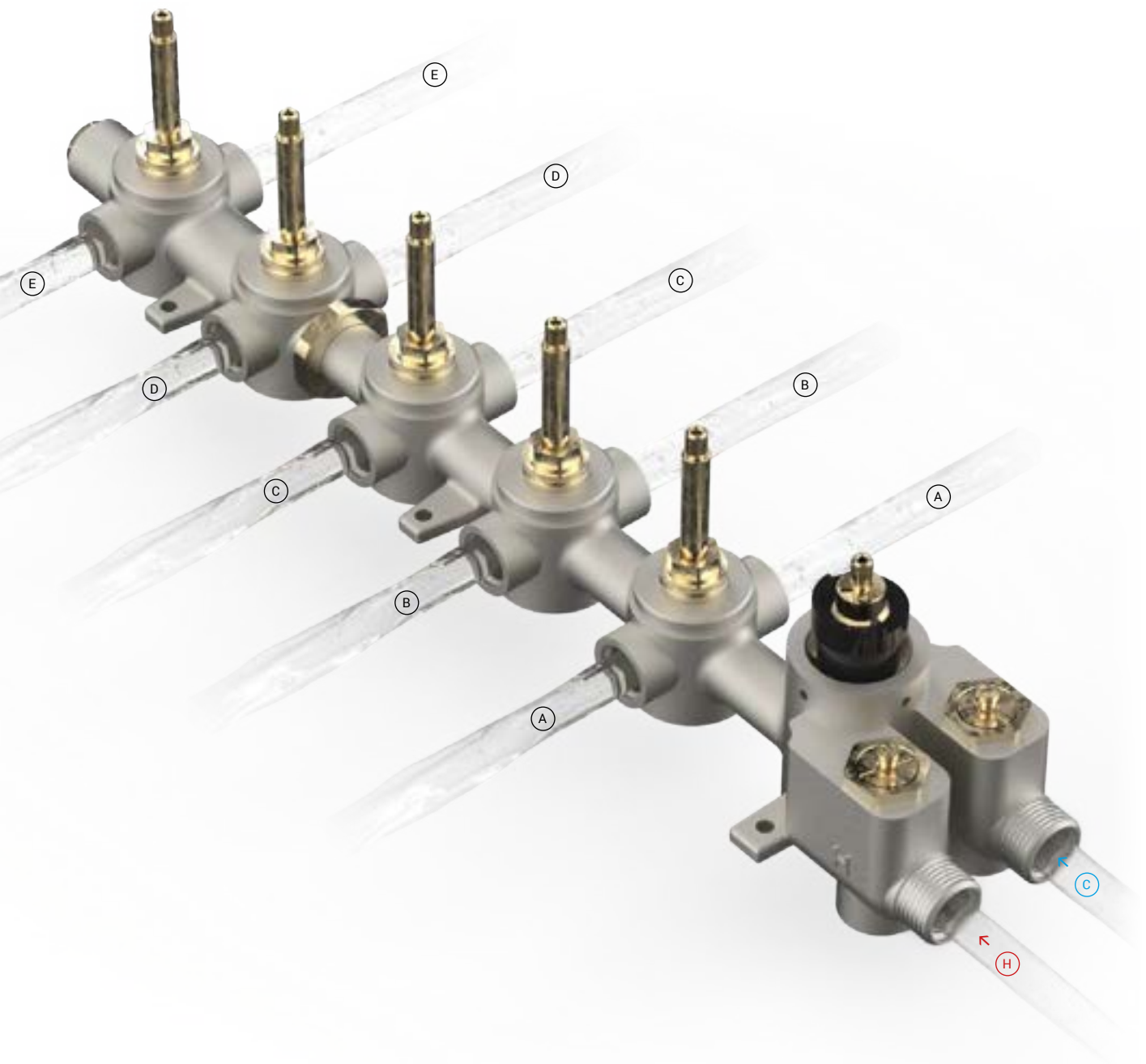

- A **Mixed water outlet**
Uscita acqua miscelata
Sortie eau mélangé
- B **Mixed water outlet**
Uscita acqua miscelata
Sortie eau mélangé
- C **Mixed water outlet**
Uscita acqua miscelata
Sortie eau mélangé

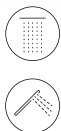

- D **Mixed water outlet**
Uscita acqua miscelata
Sortie eau mélangé
- E **Mixed water outlet**
Uscita acqua miscelata
Sortie eau mélangé



- H** **Hot water**
Acqua calda
Eau chaude
- C** **Cold water**
Acqua fredda
Eau froide

Aqua

PORTATE | WATER FLOW | DÉBIT D'EAU

| 0.2 BAR | 0.5 BAR | 1 BAR | 2 BAR | 3 BAR | 4 BAR | 5 BAR |
|----------|---------|--------|--------|--------|--------|--------|
| 10,7 l/m | 18 l/m | 26 l/m | 37 l/m | 45 l/m | 51 l/m | 56 l/m |

Hey Joe!

RECESSED BODY
CORPO INCASSO
PARTIE ENCASTRÉ
IUA500CCXN_1 14,0



PACKAGING

L: 530 mm
D: 145 mm
H: 90 mm

5,26 kg



VERTICAL | VERTICALE | VERTICAL

PLATE AND HANDLES TRIMKIT
KIT PIASTRA E MANIGLIE
KIT PLAQUE ET POIGNÉE

| | | |
|----|-------------|------|
| CC | EUA512CCNHJ | 37,4 |
| SS | EUA512SSNHJ | 46,7 |
| BO | EUA512BONHJ | 44,9 |
| NP | EUA512NPNHJ | 44,9 |
| CF | EUA512CFNHJ | 56,1 |
| CS | EUA512CSNHJ | 59,8 |
| OO | EUA512OONHJ | 56,1 |
| II | EUA512IINHJ | 56,1 |
| IS | EUA512ISNHJ | 59,8 |
| RS | EUA512RSNHJ | 56,1 |
| SR | EUA512SRNHJ | 59,8 |
| OS | EUA512OSNHJ | 59,8 |

HORIZONTAL | ORIZZONTALE | HORIZONTAL

PLATE AND HANDLES TRIMKIT
KIT PIASTRA E MANIGLIE
KIT PLAQUE ET POIGNÉE

| | | |
|----|-------------|------|
| CC | EUA522CCNHJ | 37,4 |
| SS | EUA522SSNHJ | 46,7 |
| BO | EUA522BONHJ | 44,9 |
| NP | EUA522NPNHJ | 44,9 |
| CF | EUA522CFNHJ | 56,1 |
| CS | EUA522CSNHJ | 59,8 |
| OO | EUA522OONHJ | 56,1 |
| II | EUA522IINHJ | 56,1 |
| IS | EUA522ISNHJ | 59,8 |
| RS | EUA522RSNHJ | 56,1 |
| SR | EUA522SRNHJ | 59,8 |
| OS | EUA522OSNHJ | 59,8 |

Loveme

RECESSED BODY
CORPO INCASSO
PARTIE ENCASTRÉ
IUA500CCXN_1 14,0



PACKAGING

L: 530 mm
D: 145 mm
H: 90 mm

5,26 kg



VERTICAL | VERTICALE | VERTICAL

PLATE AND HANDLES TRIMKIT
KIT PIASTRA E MANIGLIE
KIT PLAQUE ET POIGNÉE

| | | |
|----|-------------|------|
| CC | EUA512CCNLM | 37,4 |
| SS | EUA512SSNLM | 46,7 |
| BO | EUA512BONLM | 44,9 |
| NP | EUA512NPNLM | 44,9 |
| CS | EUA512CSNLM | 59,8 |
| IS | EUA512ISNLM | 59,8 |
| SR | EUA512SRNLM | 59,8 |
| OS | EUA512OSNLM | 59,8 |
| ON | EUA512ONNLM | 37,4 |

HORIZONTAL | ORIZZONTALE | HORIZONTAL

PLATE AND HANDLES TRIMKIT
KIT PIASTRA E MANIGLIE
KIT PLAQUE ET POIGNÉE

| | | |
|----|-------------|------|
| CC | EUA522CCNLM | 37,4 |
| SS | EUA522SSNLM | 46,7 |
| BO | EUA522BONLM | 44,9 |
| NP | EUA522NPNLM | 44,9 |
| CS | EUA522CSNLM | 59,8 |
| IS | EUA522ISNLM | 59,8 |
| SR | EUA522SRNLM | 59,8 |
| OS | EUA522OSNLM | 59,8 |
| ON | EUA522ONNLM | 37,4 |

Belmondo

RECESSED BODY
CORPO INCASSO
PARTIE ENCASTRÉ
IUA500CCXN_1 14,0



PACKAGING

L: 530 mm
D: 145 mm
H: 90 mm

5,26 kg



VERTICAL | VERTICALE | VERTICAL

PLATE AND HANDLES TRIMKIT
KIT PIASTRA E MANIGLIE
KIT PLAQUE ET POIGNÉE

| | | |
|----|-------------|------|
| CC | EUA512CCNBT | 37,4 |
| OO | EUA512OONBT | 56,1 |
| II | EUA512IINBT | 56,1 |
| RS | EUA512RSNBT | 56,1 |
| PL | EUA512PLNBT | 59,8 |

HORIZONTAL | ORIZZONTALE | HORIZONTAL

PLATE AND HANDLES TRIMKIT
KIT PIASTRA E MANIGLIE
KIT PLAQUE ET POIGNÉE

| | | |
|----|-------------|------|
| CC | EUA522CCNBT | 37,4 |
| OO | EUA522OONBT | 56,1 |
| II | EUA522IINBT | 56,1 |
| RS | EUA522RSNBT | 56,1 |
| PL | EUA522PLNBT | 59,8 |

Batlò

RECESSED BODY
CORPO INCASSO
PARTIE ENCASTRÉ
IUA500CCXN_1 14,0



PACKAGING

L: 530 mm
D: 145 mm
H: 90 mm

5,26 kg



VERTICAL | VERTICALE | VERTICAL

PLATE AND HANDLES TRIMKIT
KIT PIASTRA E MANIGLIE
KIT PLAQUE ET POIGNÉE

| | | |
|----|-------------|------|
| CC | EUA512CCNBI | 37,4 |
| SS | EUA512SSNBI | 46,7 |
| BO | EUA512BONBI | 44,9 |
| NP | EUA512NPNBI | 44,9 |
| CF | EUA512CFNBI | 56,1 |
| CS | EUA512CSNBI | 59,8 |
| OO | EUA512OONBI | 56,1 |
| II | EUA512IINBI | 56,1 |
| IS | EUA512ISNBI | 59,8 |
| RS | EUA512RSNBI | 56,1 |
| SR | EUA512SRNBI | 59,8 |
| OS | EUA512OSNBI | 59,8 |

HORIZONTAL | ORIZZONTALE | HORIZONTAL

PLATE AND HANDLES TRIMKIT
KIT PIASTRA E MANIGLIE
KIT PLAQUE ET POIGNÉE

| | | |
|----|-------------|------|
| CC | EUA522CCNBI | 37,4 |
| SS | EUA522SSNBI | 46,7 |
| BO | EUA522BONBI | 44,9 |
| NP | EUA522NPNBI | 44,9 |
| CF | EUA522CFNBI | 56,1 |
| CS | EUA522CSNBI | 59,8 |
| OO | EUA522OONBI | 56,1 |
| II | EUA522IINBI | 56,1 |
| IS | EUA522ISNBI | 59,8 |
| RS | EUA522RSNBI | 56,1 |
| SR | EUA522SRNBI | 59,8 |
| OS | EUA522OSNBI | 59,8 |

Kusasi

RECESSED BODY
CORPO INCASSO
PARTIE ENCASTRÉ
IUA500CCXN_1 14,0



PACKAGING

L: 530 mm
D: 145 mm
H: 90 mm

5,26 kg



VERTICAL | VERTICALE | VERTICAL

PLATE AND HANDLES TRIMKIT
KIT PIASTRA E MANIGLIE
KIT PLAQUE ET POIGNÉE

| | | |
|----|-------------|------|
| CC | EUA512CCNKU | 37,4 |
| SS | EUA512SSNKU | 46,7 |
| NP | EUA512NPNKU | 44,9 |

HORIZONTAL | ORIZZONTALE | HORIZONTAL

PLATE AND HANDLES TRIMKIT
KIT PIASTRA E MANIGLIE
KIT PLAQUE ET POIGNÉE

| | | |
|----|-------------|------|
| CC | EUA522CCNKU | 37,4 |
| SS | EUA522SSNKU | 46,7 |
| NP | EUA522NPNKU | 44,9 |

Wow

RECESSED BODY
CORPO INCASSO
PARTIE ENCASTRÉ

IUA500CCXN_1 14,0



PACKAGING

L: 530 mm
D: 145 mm
H: 90 mm

5,26 kg

VERTICAL | VERTICALE | VERTICAL

PLATE AND HANDLES TRIMKIT
KIT PIASTRA E MANIGLIE
KIT PLAQUE ET POIGNÉE

| | | |
|----|-------------|------|
| CC | EUA512CCNWO | 37,4 |
| SS | EUA512SSNWO | 46,7 |
| BO | EUA512BONWO | 44,9 |
| NP | EUA512NPNWO | 44,9 |
| OO | EUA512OONWO | 56,1 |

HORIZONTAL | ORIZZONTALE | HORIZONTAL

PLATE AND HANDLES TRIMKIT
KIT PIASTRA E MANIGLIE
KIT PLAQUE ET POIGNÉE

| | | |
|----|-------------|------|
| CC | EUA522CCNWO | 37,4 |
| SS | EUA522SSNWO | 46,7 |
| BO | EUA522BONWO | 44,9 |
| NP | EUA522NPNWO | 44,9 |
| OO | EUA522OONWO | 56,1 |

Industria

RECESSED BODY
CORPO INCASSO
PARTIE ENCASTRÉ

IUA500CCXN_1 14,0



PACKAGING

L: 530 mm
D: 145 mm
H: 90 mm

5,26 kg

VERTICAL | VERTICALE | VERTICAL

PLATE AND HANDLES TRIMKIT
KIT PIASTRA E MANIGLIE
KIT PLAQUE ET POIGNÉE

| | | |
|----|--------------|------|
| CC | EUA512CCNID1 | 37,4 |
| SS | EUA512SSNID1 | 46,7 |
| NP | EUA512NPNID1 | 44,9 |
| CF | EUA512CFNID1 | 56,1 |
| CS | EUA512CSNID1 | 59,8 |
| OO | EUA512OONID1 | 56,1 |
| II | EUA512IINID1 | 56,1 |
| IS | EUA512ISNID1 | 59,8 |
| RS | EUA512RSNID1 | 56,1 |
| SR | EUA512SRNID1 | 59,8 |
| OS | EUA512OSNID1 | 59,8 |
| ON | EUA512ONNID1 | 37,4 |

HORIZONTAL | ORIZZONTALE | HORIZONTAL

PLATE AND HANDLES TRIMKIT
KIT PIASTRA E MANIGLIE
KIT PLAQUE ET POIGNÉE

| | | |
|----|--------------|------|
| CC | EUA522CCNID1 | 37,4 |
| SS | EUA522SSNID1 | 46,7 |
| NP | EUA522NPNID1 | 44,9 |
| CF | EUA522CFNID1 | 56,1 |
| CS | EUA522CSNID1 | 59,8 |
| OO | EUA522OONID1 | 56,1 |
| II | EUA522IINID1 | 56,1 |
| IS | EUA522ISNID1 | 59,8 |
| RS | EUA522RSNID1 | 56,1 |
| SR | EUA522SRNID1 | 59,8 |
| OS | EUA522OSNID1 | 59,8 |
| ON | EUA522ONNID1 | 37,4 |

Bold

RECESSED BODY
CORPO INCASSO
PARTIE ENCASTRÉ

IUA500CCXN_1 14,0



PACKAGING

L: 530 mm
D: 145 mm
H: 90 mm

5,26 kg

VERTICAL | VERTICALE | VERTICAL

PLATE AND HANDLES TRIMKIT
KIT PIASTRA E MANIGLIE
KIT PLAQUE ET POIGNÉE

| | | |
|----|-------------|------|
| CC | EUA512CCNB1 | 40,4 |
| SS | EUA512SSNB1 | 50,5 |
| NP | EUA512NPNB1 | 48,5 |
| CF | EUA512CFNB1 | 60,7 |
| CS | EUA512CSNB1 | 64,7 |
| OO | EUA512OONB1 | 60,7 |
| II | EUA512IINB1 | 60,7 |
| IS | EUA512ISNB1 | 64,7 |
| RS | EUA512RSNB1 | 60,7 |
| SR | EUA512SRNB1 | 64,7 |
| OS | EUA512OSNB1 | 64,7 |
| ON | EUA512ONNB1 | 40,4 |

HORIZONTAL | ORIZZONTALE | HORIZONTAL

PLATE AND HANDLES TRIMKIT
KIT PIASTRA E MANIGLIE
KIT PLAQUE ET POIGNÉE

| | | |
|----|-------------|------|
| CC | EUA522CCNB1 | 40,4 |
| SS | EUA522SSNB1 | 50,5 |
| NP | EUA522NPNB1 | 48,5 |
| CF | EUA522CFNB1 | 60,7 |
| CS | EUA522CSNB1 | 64,7 |
| OO | EUA522OONB1 | 60,7 |
| II | EUA522IINB1 | 60,7 |
| IS | EUA522ISNB1 | 64,7 |
| RS | EUA522RSNB1 | 60,7 |
| SR | EUA522SRNB1 | 64,7 |
| OS | EUA522OSNB1 | 64,7 |
| ON | EUA522ONNB1 | 40,4 |

Birkin

RECESSED BODY
CORPO INCASSO
PARTIE ENCASTRÉ

IUA500CCXN_1 14,0



PACKAGING

L: 530 mm
D: 145 mm
H: 90 mm

5,26 kg

VERTICAL | VERTICALE | VERTICAL

PLATE AND HANDLES TRIMKIT
KIT PIASTRA E MANIGLIE
KIT PLAQUE ET POIGNÉE

| | | |
|----|--------------|------|
| CC | EUA512CCNBR3 | 52,4 |
| SS | EUA512SSNBR3 | 65,5 |
| RS | EUA512RSNBR3 | 78,7 |
| OS | EUA512OSNBR3 | 83,9 |
| PL | EUA512PLNBR3 | 83,9 |

HORIZONTAL | ORIZZONTALE | HORIZONTAL

PLATE AND HANDLES TRIMKIT
KIT PIASTRA E MANIGLIE
KIT PLAQUE ET POIGNÉE

| | | |
|----|--------------|------|
| CC | EUA522CCNBR3 | 52,4 |
| SS | EUA522SSNBR3 | 65,5 |
| RS | EUA522RSNBR3 | 78,7 |
| OS | EUA522OSNBR3 | 83,9 |
| PL | EUA522PLNBR3 | 83,9 |

Marmo

RECESSED BODY
CORPO INCASSO
PARTIE ENCASTRÉ

IUA500CCXN_1 14,0



PACKAGING

L: 530 mm
D: 145 mm
H: 90 mm

5,50 kg

MARBLE

White Carrara

Black Marquina

VERTICAL | VERTICALE | VERTICAL

PLATE AND HANDLES TRIMKIT
KIT PIASTRA E MANIGLIE
KIT PLAQUE ET POIGNÉE

| | | | |
|----|--------------|--------------|------|
| CC | EUA512CCNMR1 | EUA512CCNMR2 | 47,8 |
| SS | EUA512SSNMR1 | EUA512SSNMR2 | 59,8 |
| BO | EUA512BONMR1 | EUA512BONMR2 | 57,4 |
| NP | EUA512NPNMR1 | EUA512NPNMR2 | 57,4 |
| CF | EUA512CFNMR1 | EUA512CFNMR2 | 71,7 |
| CS | EUA512CSNMR1 | EUA512CSNMR2 | 76,5 |
| OO | EUA512OONMR1 | EUA512OONMR2 | 71,7 |
| II | EUA512IINMR1 | EUA512IINMR2 | 71,7 |
| IS | EUA512ISNMR1 | EUA512ISNMR2 | 76,5 |
| RS | EUA512RSNMR1 | EUA512RSNMR2 | 71,7 |
| SR | EUA512SRNMR1 | EUA512SRNMR2 | 76,5 |
| OS | EUA512OSNMR1 | EUA512OSNMR2 | 76,5 |
| ON | EUA512ONNMR1 | EUA512PLNMR2 | 47,8 |
| PL | EUA512PLNMR1 | EUA512PLNMR2 | 76,5 |

HORIZONTAL | ORIZZONTALE | HORIZONTAL

PLATE AND HANDLES TRIMKIT
KIT PIASTRA E MANIGLIE
KIT PLAQUE ET POIGNÉE

| | | | |
|----|--------------|--------------|------|
| CC | EUA522CCNMR1 | EUA522CCNMR2 | 47,8 |
| SS | EUA522SSNMR1 | EUA522SSNMR2 | 59,8 |
| BO | EUA522BONMR1 | EUA522BONMR2 | 57,4 |
| NP | EUA522NPNMR1 | EUA522NPNMR2 | 57,4 |
| CF | EUA522CFNMR1 | EUA522CFNMR2 | 71,7 |
| CS | EUA522CSNMR1 | EUA522CSNMR2 | 76,5 |
| OO | EUA522OONMR1 | EUA522OONMR2 | 71,7 |
| II | EUA522IINMR1 | EUA522IINMR2 | 71,7 |
| IS | EUA522ISNMR1 | EUA522ISNMR2 | 76,5 |
| RS | EUA522RSNMR1 | EUA522RSNMR2 | 71,7 |
| SR | EUA522SRNMR1 | EUA522SRNMR2 | 76,5 |
| OS | EUA522OSNMR1 | EUA522OSNMR2 | 76,5 |
| ON | EUA522ONNMR1 | EUA522PLNMR2 | 47,8 |
| PL | EUA522PLNMR1 | EUA522PLNMR2 | 76,5 |

Aqua

Rubacuori



RECESSED BODY
CORPO INCASSO
PARTIE ENCASTRÉ
IUA500CCXN_1 14,0

PACKAGING

L: 530 mm
D: 145 mm
H: 90 mm

5,26 kg



VERTICAL | VERTICALE | VERTICAL

PLATE AND HANDLES TRIMKIT
KIT PIASTRA E MANIGLIE
KIT PLAQUE ET POIGNÉE

| | | |
|----|-------------|------|
| CC | EUA511CCNRU | 37,4 |
| SS | EUA511SSNRU | 46,7 |
| BO | EUA511BONRU | 44,9 |
| NP | EUA511NPNRU | 44,9 |
| CF | EUA511CFNRU | 56,1 |
| CS | EUA511CSNRU | 59,8 |
| OO | EUA511OONRU | 56,1 |
| II | EUA511IINRU | 56,1 |
| IS | EUA511ISNRU | 59,8 |
| RS | EUA511RSNRU | 56,1 |
| SR | EUA511SRNRU | 59,8 |
| OS | EUA511OSNRU | 59,8 |

HORIZONTAL | ORIZZONTALE | HORIZONTAL

PLATE AND HANDLES TRIMKIT
KIT PIASTRA E MANIGLIE
KIT PLAQUE ET POIGNÉE

| | | |
|----|-------------|------|
| CC | EUA521CCNRU | 37,4 |
| SS | EUA521SSNRU | 46,7 |
| BO | EUA521BONRU | 44,9 |
| NP | EUA521NPNRU | 44,9 |
| CF | EUA521CFNRU | 56,1 |
| CS | EUA521CSNRU | 59,8 |
| OO | EUA521OONRU | 56,1 |
| II | EUA521IINRU | 56,1 |
| IS | EUA521ISNRU | 59,8 |
| RS | EUA521RSNRU | 56,1 |
| SR | EUA521SRNRU | 59,8 |
| OS | EUA521OSNRU | 59,8 |

Hey joe!



RECESSED BODY
CORPO INCASSO
PARTIE ENCASTRÉ
IUA500CCXN_1 14,0

PACKAGING

L: 530 mm
D: 145 mm
H: 90 mm

5,26 kg



VERTICAL | VERTICALE | VERTICAL

PLATE AND HANDLES TRIMKIT
KIT PIASTRA E MANIGLIE
KIT PLAQUE ET POIGNÉE

| | | |
|----|-------------|------|
| CC | EUA511CCNHJ | 37,4 |
| SS | EUA511SSNHJ | 46,7 |
| BO | EUA511BONHJ | 44,9 |
| NP | EUA511NPNHJ | 44,9 |
| CF | EUA511CFNHJ | 56,1 |
| CS | EUA511CSNHJ | 59,8 |
| OO | EUA511OONHJ | 56,1 |
| II | EUA511IINHJ | 56,1 |
| IS | EUA511ISNHJ | 59,8 |
| RS | EUA511RSNHJ | 56,1 |
| SR | EUA511SRNHJ | 59,8 |
| OS | EUA511OSNHJ | 59,8 |

HORIZONTAL | ORIZZONTALE | HORIZONTAL

PLATE AND HANDLES TRIMKIT
KIT PIASTRA E MANIGLIE
KIT PLAQUE ET POIGNÉE

| | | |
|----|-------------|------|
| CC | EUA521CCNHJ | 37,4 |
| SS | EUA521SSNHJ | 46,7 |
| BO | EUA521BONHJ | 44,9 |
| NP | EUA521NPNHJ | 44,9 |
| CF | EUA521CFNHJ | 56,1 |
| CS | EUA521CSNHJ | 59,8 |
| OO | EUA521OONHJ | 56,1 |
| II | EUA521IINHJ | 56,1 |
| IS | EUA521ISNHJ | 59,8 |
| RS | EUA521RSNHJ | 56,1 |
| SR | EUA521SRNHJ | 59,8 |
| OS | EUA521OSNHJ | 59,8 |

Belmondo



RECESSED BODY
CORPO INCASSO
PARTIE ENCASTRÉ
IUA500CCXN_1 14,0

PACKAGING

L: 530 mm
D: 145 mm
H: 90 mm

5,26 kg



VERTICAL | VERTICALE | VERTICAL

PLATE AND HANDLES TRIMKIT
KIT PIASTRA E MANIGLIE
KIT PLAQUE ET POIGNÉE

| | | |
|----|-------------|------|
| CC | EUA511CCNBT | 37,4 |
| OO | EUA511OONBT | 56,1 |
| II | EUA511IINBT | 56,1 |
| RS | EUA511RSNBT | 56,1 |
| PL | EUA511PLNBT | 59,8 |

HORIZONTAL | ORIZZONTALE | HORIZONTAL

PLATE AND HANDLES TRIMKIT
KIT PIASTRA E MANIGLIE
KIT PLAQUE ET POIGNÉE

| | | |
|----|-------------|------|
| CC | EUA521CCNBT | 37,4 |
| OO | EUA521OONBT | 56,1 |
| II | EUA521IINBT | 56,1 |
| RS | EUA521RSNBT | 56,1 |
| PL | EUA521PLNBT | 59,8 |

Kusasi



RECESSED BODY
CORPO INCASSO
PARTIE ENCASTRÉ
IUA500CCXN_1 14,0

PACKAGING

L: 530 mm
D: 145 mm
H: 90 mm

5,26 kg



VERTICAL | VERTICALE | VERTICAL

PLATE AND HANDLES TRIMKIT
KIT PIASTRA E MANIGLIE
KIT PLAQUE ET POIGNÉE

| | | |
|----|-------------|------|
| CC | EUA511CCNKU | 37,4 |
| SS | EUA511SSNKU | 46,7 |
| NP | EUA511NPNKU | 44,9 |

HORIZONTAL | ORIZZONTALE | HORIZONTAL

PLATE AND HANDLES TRIMKIT
KIT PIASTRA E MANIGLIE
KIT PLAQUE ET POIGNÉE

| | | |
|----|-------------|------|
| CC | EUA521CCNKU | 37,4 |
| SS | EUA521SSNKU | 46,7 |
| NP | EUA521NPNKU | 44,9 |

Wow



RECESSED BODY
CORPO INCASSO
PARTIE ENCASTRÉ
IUA500CCXN_1 14,0

PACKAGING

L: 530 mm
D: 145 mm
H: 90 mm

5,26 kg



VERTICAL | VERTICALE | VERTICAL

PLATE AND HANDLES TRIMKIT
KIT PIASTRA E MANIGLIE
KIT PLAQUE ET POIGNÉE

| | | |
|----|-------------|------|
| CC | EUA511CCNWO | 37,4 |
| SS | EUA511SSNWO | 46,7 |
| BO | EUA511BONWO | 44,9 |
| NP | EUA511NPNWO | 44,9 |
| OO | EUA511OONWO | 56,1 |

HORIZONTAL | ORIZZONTALE | HORIZONTAL

PLATE AND HANDLES TRIMKIT
KIT PIASTRA E MANIGLIE
KIT PLAQUE ET POIGNÉE

| | | |
|----|-------------|------|
| CC | EUA521CCNWO | 37,4 |
| SS | EUA521SSNWO | 46,7 |
| BO | EUA521BONWO | 44,9 |
| NP | EUA521NPNWO | 44,9 |
| OO | EUA521OONWO | 56,1 |

Industria

RECESSED BODY
CORPO INCASSO
PARTIE ENCASTRÉ

IUA500CCXN_1 14,0



PACKAGING

L: 530 mm
D: 145 mm
H: 90 mm

5,26 kg

VERTICAL | VERTICALE | VERTICAL

PLATE AND HANDLES TRIMKIT
KIT PIASTRA E MANIGLIE
KIT PLAQUE ET POIGNÉE

| | | |
|----|--------------|------|
| CC | EUA511CCNID1 | 37,4 |
| SS | EUA511SSNID1 | 46,7 |
| NP | EUA511NPNID1 | 44,9 |
| CF | EUA511CFNID1 | 56,1 |
| CS | EUA511CSNID1 | 59,8 |
| OO | EUA511OONID1 | 56,1 |
| II | EUA511IINID1 | 56,1 |
| IS | EUA511ISNID1 | 59,8 |
| RS | EUA511RSNID1 | 56,1 |
| SR | EUA511SRNID1 | 59,8 |
| OS | EUA511OSNID1 | 59,8 |
| ON | EUA511ONNID1 | 37,4 |

HORIZONTAL | ORIZZONTALE | HORIZONTAL

PLATE AND HANDLES TRIMKIT
KIT PIASTRA E MANIGLIE
KIT PLAQUE ET POIGNÉE

| | | |
|----|--------------|------|
| CC | EUA521CCNID1 | 37,4 |
| SS | EUA521SSNID1 | 46,7 |
| NP | EUA521NPNID1 | 44,9 |
| CF | EUA521CFNID1 | 56,1 |
| CS | EUA521CSNID1 | 59,8 |
| OO | EUA521OONID1 | 56,1 |
| II | EUA521IINID1 | 56,1 |
| IS | EUA521ISNID1 | 59,8 |
| RS | EUA521RSNID1 | 56,1 |
| SR | EUA521SRNID1 | 59,8 |
| OS | EUA521OSNID1 | 59,8 |
| ON | EUA521ONNID1 | 37,4 |

Marmo

RECESSED BODY
CORPO INCASSO
PARTIE ENCASTRÉ

IUA500CCXN_1 14,0



PACKAGING

L: 530 mm
D: 145 mm
H: 90 mm

5,50 kg

MARBLE

White Carrara

Black Marquina

VERTICAL | VERTICALE | VERTICAL

PLATE AND HANDLES TRIMKIT
KIT PIASTRA E MANIGLIE
KIT PLAQUE ET POIGNÉE

| | | | |
|----|--------------|--------------|------|
| CC | EUA511CCNMR1 | EUA511CCNMR2 | 47,8 |
| SS | EUA511SSNMR1 | EUA511SSNMR2 | 59,8 |
| BO | EUA511BONMR1 | EUA511BONMR2 | 57,4 |
| NP | EUA511NPNMR1 | EUA511NPNMR2 | 57,4 |
| CF | EUA511CFNMR1 | EUA511CFNMR2 | 71,7 |
| CS | EUA511CSNMR1 | EUA511CSNMR2 | 76,5 |
| OO | EUA511OONMR1 | EUA511OONMR2 | 71,7 |
| II | EUA511IINMR1 | EUA511IINMR2 | 71,7 |
| IS | EUA511ISNMR1 | EUA511ISNMR2 | 76,5 |
| RS | EUA511RSNMR1 | EUA511RSNMR2 | 71,7 |
| SR | EUA511SRNMR1 | EUA511SRNMR2 | 76,5 |
| OS | EUA511OSNMR1 | EUA511OSNMR2 | 76,5 |
| ON | EUA511ONNMR1 | EUA511PLNMR2 | 47,8 |
| PL | EUA511PLNMR1 | EUA511PLNMR2 | 76,5 |

HORIZONTAL | ORIZZONTALE | HORIZONTAL

PLATE AND HANDLES TRIMKIT
KIT PIASTRA E MANIGLIE
KIT PLAQUE ET POIGNÉE

| | | | |
|----|--------------|--------------|------|
| CC | EUA521CCNMR1 | EUA521CCNMR2 | 47,8 |
| SS | EUA521SSNMR1 | EUA521SSNMR2 | 59,8 |
| BO | EUA521BONMR1 | EUA521BONMR2 | 57,4 |
| NP | EUA521NPNMR1 | EUA521NPNMR2 | 57,4 |
| CF | EUA521CFNMR1 | EUA521CFNMR2 | 71,7 |
| CS | EUA521CSNMR1 | EUA521CSNMR2 | 76,5 |
| OO | EUA521OONMR1 | EUA521OONMR2 | 71,7 |
| II | EUA521IINMR1 | EUA521IINMR2 | 71,7 |
| IS | EUA521ISNMR1 | EUA521ISNMR2 | 76,5 |
| RS | EUA521RSNMR1 | EUA521RSNMR2 | 71,7 |
| SR | EUA521SRNMR1 | EUA521SRNMR2 | 76,5 |
| OS | EUA521OSNMR1 | EUA521OSNMR2 | 76,5 |
| ON | EUA521ONNMR1 | EUA521PLNMR2 | 47,8 |
| PL | EUA521PLNMR1 | EUA521PLNMR2 | 76,5 |

Hermes

RECESSED BODY
CORPO INCASSO
PARTIE ENCASTRÉ

IUA500CCXN_1 14,0



PACKAGING

L: 530 mm
D: 145 mm
H: 90 mm

5,26 kg

VERTICAL | VERTICALE | VERTICAL

PLATE AND HANDLES TRIMKIT
KIT PIASTRA E MANIGLIE
KIT PLAQUE ET POIGNÉE

| | | |
|----|-------------|------|
| CC | EUA515CCNHR | 37,8 |
| SS | EUA515SSNHR | 47,3 |
| II | EUA515IINHR | 56,7 |
| RS | EUA515RSNHR | 56,7 |
| OS | EUA515OSNHR | 60,5 |
| RR | EUA515RRNHR | 52,9 |
| BB | EUA515BBNHR | 52,9 |
| PL | EUA515PLNHR | 60,5 |

HORIZONTAL | ORIZZONTALE | HORIZONTAL

PLATE AND HANDLES TRIMKIT
KIT PIASTRA E MANIGLIE
KIT PLAQUE ET POIGNÉE

| | | |
|----|-------------|------|
| CC | EUA525CCNHR | 37,8 |
| SS | EUA525SSNHR | 47,3 |
| II | EUA525IINHR | 56,7 |
| RS | EUA525RSNHR | 56,7 |
| OS | EUA525OSNHR | 60,5 |
| RR | EUA525RRNHR | 52,9 |
| BB | EUA525BBNHR | 52,9 |
| PL | EUA525PLNHR | 60,5 |

Birkin

RECESSED BODY
CORPO INCASSO
PARTIE ENCASTRÉ

IUA500CCXN_1 14,0



PACKAGING

L: 530 mm
D: 145 mm
H: 90 mm

5,26 kg

VERTICAL | VERTICALE | VERTICAL

PLATE AND HANDLES TRIMKIT
KIT PIASTRA E MANIGLIE
KIT PLAQUE ET POIGNÉE

| | | |
|----|--------------|------|
| CC | EUA515CCNBR3 | 52,4 |
| SS | EUA515SSNBR3 | 65,5 |
| RS | EUA515RSNBR3 | 78,7 |
| OS | EUA515OSNBR3 | 83,9 |
| PL | EUA515PLNBR3 | 83,9 |

HORIZONTAL | ORIZZONTALE | HORIZONTAL

PLATE AND HANDLES TRIMKIT
KIT PIASTRA E MANIGLIE
KIT PLAQUE ET POIGNÉE

| | | |
|----|--------------|------|
| CC | EUA525CCNBR3 | 52,4 |
| SS | EUA525SSNBR3 | 65,5 |
| RS | EUA525RSNBR3 | 78,7 |
| OS | EUA525OSNBR3 | 83,9 |
| PL | EUA525PLNBR3 | 83,9 |

Aqua

AQUA

Diverter 2 ways

2 Vie con deviatore
2 voies avec déviateur

ARTICLE | ARTICOLO | ARTICLE

IUA002CCXN_1

Only the built-in 1\2" thermostatic unit of compact size, horizontal / vertical installation
Solo parte incasso termostatico 1/2 " ingombro ridotto, installazione orizzontale / verticale.
Seulement partie encastré du thermostatique 1/2" économie d'espace, installation horizontale / vertical.

CODE / COEFFICIENT | CODICE / COEFFICIENTE | CODE / COEFFICIENT

8,8

TECHNICAL DATA

Minimum dynamic pressure 0,5 bar
Maximum operational pressure 5 bar
Recommended operational pressure da 1 a 5 bar
Maximum hot water temperature 80°C

GENERAL FEATURES

Installation depth from 80 mm to 90 mm.
The intakes are fitted with G1/2" AU G3/4" M female threaded connection, the outlets only G1/2" F (1, 2 or 3 way).
The temperature regulator lever is pre-set at 38°C.
Use of a pressure reducer is recommended if pressures in the system exceed 5 bar.

DATI TECNICI

Pressione dinamica minima 0,5 bar
Pressione di esercizio massima 5 bar
Pressione di utilizzo raccomandata da 1 a 5 bar
Temperatura massima acqua calda 80°C

CARATTERISTICHE GENERALI

Profondità di installazione da 80 mm a 90 mm.
Le entrate vengono fornite con filetto G1/2" femmina G3/4" maschio, le uscite solo G1/2" F (1, 2 o 3 vie).
La maniglia di regolazione temperatura, viene pre-settata a 38°C.
Si raccomanda l'utilizzo di un riduttore di pressione, se all'interno dell'impianto, si hanno pressioni superiori a 5 bar.

DONNÉES TECHNIQUES

Pression dynamique minimum 0,5 bar
Pression de service maximale de 5 bar
Pression d'utilisation conseillé de 1 à 5 bar
Température maximale de l'eau chaude 80 ° C

CARACTERISTIQUES GENERALES

Profondeur de montage de 80 mm à 90 mm.
Les entrées sont fournis avec filetage G1/2" femelle G3/4" mâle, les sorties G1/2" F (1,2,ou 3 voies).
La poignée de réglage de la température, est pré-réglée à 38 ° C Si à l'intérieur du système vous avez des pressions supérieures à 5 bars, il est recommandé l'utilisation d'un réducteur de pression..

Built-in part - Parte incasso - Corps encastré

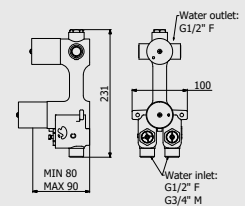

Plate and handles - Parte esterna - Plaque et poignée

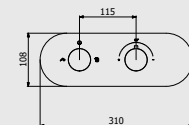
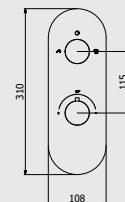

Plate and handles - Parte esterna - Plaque et poignée



PACKAGING

L: 240 mm D: 115 mm H: 160 mm 3,4 kg

ORIENTATION | ORIENTAZIONE | ORIENTATION

2 ways to Installation: horizontal or vertical
2 modalità di installazione: verticale o orizzontale
2 modalitè de installation: vertical ou horizontal.

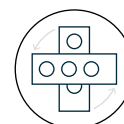

FOR ALL MODELS
PER TUTTI I MODELLI
POUR TOUS LES MODÈLES



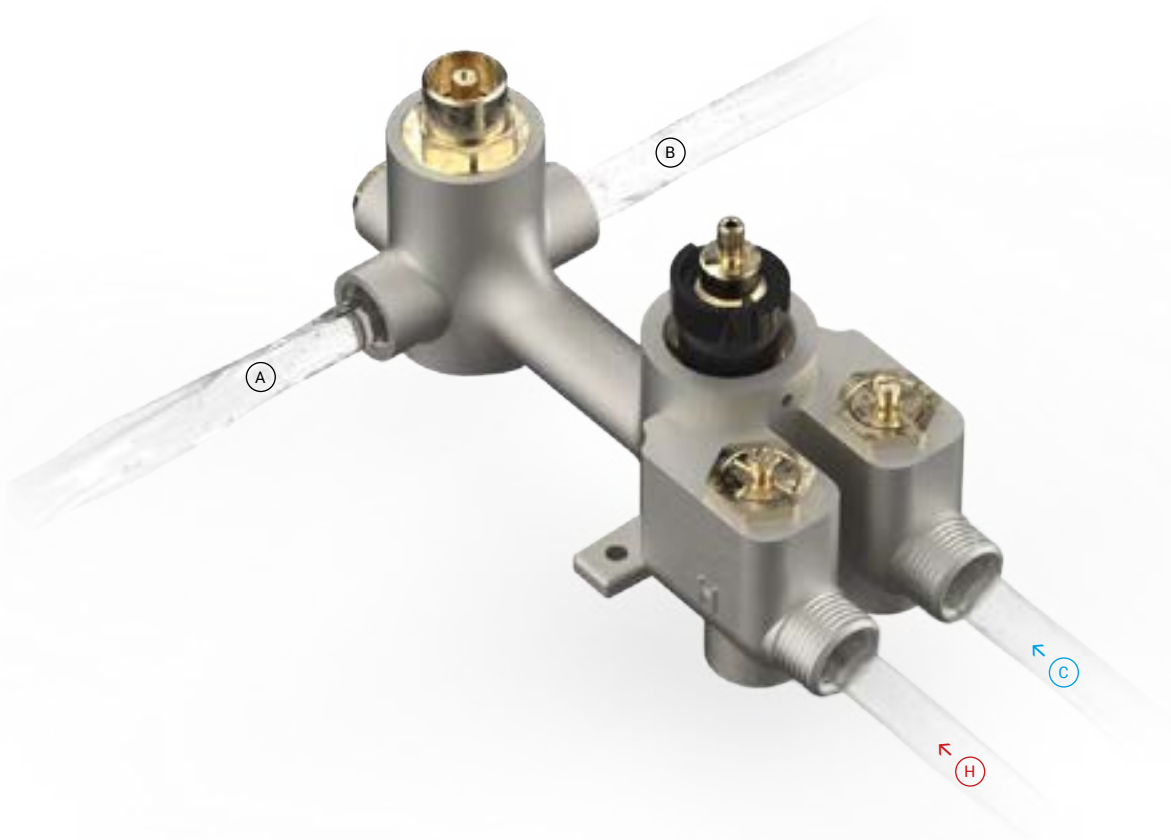

A Mixed water outlet
Uscita acqua miscelata
Sortie eau mélangé



B Mixed water outlet
Uscita acqua miscelata
Sortie eau mélangé



H Hot water
Acqua calda
Eau chaude



C Cold water
Acqua fredda
Eau froide

Aqua

PORTATE | WATER FLOW | DÉBIT D'EAU

| 0.2 BAR | 0.5 BAR | 1 BAR | 2 BAR | 3 BAR | 4 BAR | 5 BAR |
|----------|---------|--------|--------|--------|--------|--------|
| 10,7 l/m | 18 l/m | 26 l/m | 37 l/m | 45 l/m | 51 l/m | 56 l/m |

Hey Joe!



RECESSED BODY
CORPO INCASSO
PARTIE ENCASTRÉ
IUA002CCXN_1 8,8

PACKAGING

L: 530 mm
D: 145 mm
H: 90 mm

4,16 kg



VERTICAL | VERTICALE | VERTICAL

PLATE AND HANDLES TRIMKIT
KIT PIASTRA E MANIGLIE
KIT PLAQUE ET POIGNÉE

| | | |
|----|-------------|------|
| CC | EUA612CCNHJ | 17,3 |
| SS | EUA612SSNHJ | 21,6 |
| BO | EUA612BONHJ | 20,8 |
| NP | EUA612NPNHJ | 20,8 |
| CF | EUA612CFNHJ | 26,0 |
| CS | EUA612CSNHJ | 27,7 |
| OO | EUA612OONHJ | 26,0 |
| II | EUA612IINHJ | 26,0 |
| IS | EUA612ISNHJ | 27,7 |
| RS | EUA612RSNHJ | 26,0 |
| SR | EUA612SRNHJ | 27,7 |
| OS | EUA612OSNHJ | 27,7 |

HORIZONTAL | ORIZZONTALE | HORIZONTAL

PLATE AND HANDLES TRIMKIT
KIT PIASTRA E MANIGLIE
KIT PLAQUE ET POIGNÉE

| | | |
|----|-------------|------|
| CC | EUA622CCNHJ | 17,3 |
| SS | EUA622SSNHJ | 21,6 |
| BO | EUA622BONHJ | 20,8 |
| NP | EUA622NPNHJ | 20,8 |
| CF | EUA622CFNHJ | 26,0 |
| CS | EUA622CSNHJ | 27,7 |
| OO | EUA622OONHJ | 26,0 |
| II | EUA622IINHJ | 26,0 |
| IS | EUA622ISNHJ | 27,7 |
| RS | EUA622RSNHJ | 26,0 |
| SR | EUA622SRNHJ | 27,7 |
| OS | EUA622OSNHJ | 27,7 |

Loveme



RECESSED BODY
CORPO INCASSO
PARTIE ENCASTRÉ
IUA002CCXN_1 8,8

PACKAGING

L: 530 mm
D: 145 mm
H: 90 mm

4,16 kg



VERTICAL | VERTICALE | VERTICAL

PLATE AND HANDLES TRIMKIT
KIT PIASTRA E MANIGLIE
KIT PLAQUE ET POIGNÉE

| | | |
|----|-------------|------|
| CC | EUA612CCNLM | 17,3 |
| SS | EUA612SSNLM | 21,6 |
| BO | EUA612BONLM | 20,8 |
| NP | EUA612NPNLM | 20,8 |
| CS | EUA612CSNLM | 27,7 |
| IS | EUA612ISNLM | 27,7 |
| SR | EUA612SRNLM | 27,7 |
| OS | EUA612OSNLM | 27,7 |
| ON | EUA612ONNLM | 17,3 |

HORIZONTAL | ORIZZONTALE | HORIZONTAL

PLATE AND HANDLES TRIMKIT
KIT PIASTRA E MANIGLIE
KIT PLAQUE ET POIGNÉE

| | | |
|----|-------------|------|
| CC | EUA622CCNLM | 17,3 |
| SS | EUA622SSNLM | 21,6 |
| BO | EUA622BONLM | 20,8 |
| NP | EUA622NPNLM | 20,8 |
| CS | EUA622CSNLM | 27,7 |
| IS | EUA622ISNLM | 27,7 |
| SR | EUA622SRNLM | 27,7 |
| OS | EUA622OSNLM | 27,7 |
| ON | EUA622ONNLM | 17,3 |

Belmondo



RECESSED BODY
CORPO INCASSO
PARTIE ENCASTRÉ
IUA002CCXN_1 8,8

PACKAGING

L: 530 mm
D: 145 mm
H: 90 mm

4,16 kg



VERTICAL | VERTICALE | VERTICAL

PLATE AND HANDLES TRIMKIT
KIT PIASTRA E MANIGLIE
KIT PLAQUE ET POIGNÉE

| | | |
|----|-------------|------|
| CC | EUA612CCNBT | 17,3 |
| OO | EUA612OONBT | 26,0 |
| II | EUA612IINBT | 26,0 |
| RS | EUA612RSNBT | 26,0 |
| PL | EUA612PLNBT | 27,7 |

HORIZONTAL | ORIZZONTALE | HORIZONTAL

PLATE AND HANDLES TRIMKIT
KIT PIASTRA E MANIGLIE
KIT PLAQUE ET POIGNÉE

| | | |
|----|-------------|------|
| CC | EUA622CCNBT | 17,3 |
| OO | EUA622OONBT | 26,0 |
| II | EUA622IINBT | 26,0 |
| RS | EUA622RSNBT | 26,0 |
| PL | EUA622PLNBT | 27,7 |

Batlò



RECESSED BODY
CORPO INCASSO
PARTIE ENCASTRÉ
IUA002CCXN_1 8,8

PACKAGING

L: 530 mm
D: 145 mm
H: 90 mm

4,16 kg



VERTICAL | VERTICALE | VERTICAL

PLATE AND HANDLES TRIMKIT
KIT PIASTRA E MANIGLIE
KIT PLAQUE ET POIGNÉE

| | | |
|----|-------------|------|
| CC | EUA612CCNBI | 17,3 |
| SS | EUA612SSNBI | 21,6 |
| BO | EUA612BONBI | 20,8 |
| NP | EUA612NPNBI | 20,8 |
| CF | EUA612CFNBI | 26,0 |
| CS | EUA612CSNBI | 27,7 |
| OO | EUA612OONBI | 26,0 |
| II | EUA612IINBI | 26,0 |
| IS | EUA612ISNBI | 27,7 |
| RS | EUA612RSNBI | 26,0 |
| SR | EUA612SRNBI | 27,7 |
| OS | EUA612OSNBI | 27,7 |

HORIZONTAL | ORIZZONTALE | HORIZONTAL

PLATE AND HANDLES TRIMKIT
KIT PIASTRA E MANIGLIE
KIT PLAQUE ET POIGNÉE

| | | |
|----|-------------|------|
| CC | EUA622CCNBI | 17,3 |
| SS | EUA622SSNBI | 21,6 |
| BO | EUA622BONBI | 20,8 |
| NP | EUA622NPNBI | 20,8 |
| CF | EUA622CFNBI | 26,0 |
| CS | EUA622CSNBI | 27,7 |
| OO | EUA622OONBI | 26,0 |
| II | EUA622IINBI | 26,0 |
| IS | EUA622ISNBI | 27,7 |
| RS | EUA622RSNBI | 26,0 |
| SR | EUA622SRNBI | 27,7 |
| OS | EUA622OSNBI | 27,7 |

Kusasi



RECESSED BODY
CORPO INCASSO
PARTIE ENCASTRÉ
IUA002CCXN_1 8,8

PACKAGING

L: 530 mm
D: 145 mm
H: 90 mm

4,16 kg



VERTICAL | VERTICALE | VERTICAL

PLATE AND HANDLES TRIMKIT
KIT PIASTRA E MANIGLIE
KIT PLAQUE ET POIGNÉE

| | | |
|----|-------------|------|
| CC | EUA612CCNKU | 17,3 |
| SS | EUA612SSNKU | 21,6 |
| NP | EUA612NPNKU | 20,8 |

HORIZONTAL | ORIZZONTALE | HORIZONTAL

PLATE AND HANDLES TRIMKIT
KIT PIASTRA E MANIGLIE
KIT PLAQUE ET POIGNÉE

| | | |
|----|-------------|------|
| CC | EUA622CCNKU | 17,3 |
| SS | EUA622SSNKU | 21,6 |
| NP | EUA622NPNKU | 20,8 |



Wow



RECESSED BODY
CORPO INCASSO
PARTIE ENCASTRÉ
IUA002CCXN_1 8,8

PACKAGING

L: 530 mm
D: 145 mm
H: 90 mm
 4,16 kg

VERTICAL | VERTICALE | VERTICAL

PLATE AND HANDLES TRIMKIT
KIT PIASTRA E MANIGLIE
KIT PLAQUE ET POIGNÉE

| | | | |
|--|----|-------------|------|
| | CC | EUA612CCNWO | 17,3 |
| | SS | EUA612SSNWO | 21,6 |
| | BO | EUA612BONWO | 20,8 |
| | NP | EUA612NPNWO | 20,8 |
| | OO | EUA612OONWO | 26,0 |

HORIZONTAL | ORIZZONTALE | HORIZONTAL

PLATE AND HANDLES TRIMKIT
KIT PIASTRA E MANIGLIE
KIT PLAQUE ET POIGNÉE

| | | | |
|--|----|-------------|------|
| | CC | EUA622CCNWO | 17,3 |
| | SS | EUA622SSNWO | 21,6 |
| | BO | EUA622BONWO | 20,8 |
| | NP | EUA622NPNWO | 20,8 |
| | OO | EUA622OONWO | 26,0 |

Industria



RECESSED BODY
CORPO INCASSO
PARTIE ENCASTRÉ
IUA002CCXN_1 8,8

PACKAGING

L: 530 mm
D: 145 mm
H: 90 mm
 4,16 kg

VERTICAL | VERTICALE | VERTICAL

PLATE AND HANDLES TRIMKIT
KIT PIASTRA E MANIGLIE
KIT PLAQUE ET POIGNÉE

| | | | |
|--|----|--------------|------|
| | CC | EUA612CCNID1 | 17,3 |
| | SS | EUA612SSNID1 | 21,6 |
| | NP | EUA612NPNID1 | 20,8 |
| | CF | EUA612CFNID1 | 26,0 |
| | CS | EUA612CSNID1 | 27,7 |
| | OO | EUA612OONID1 | 26,0 |
| | II | EUA612IINID1 | 26,0 |
| | IS | EUA612ISNID1 | 27,7 |
| | RS | EUA612RSNID1 | 26,0 |
| | SR | EUA612SRNID1 | 27,7 |
| | OS | EUA612OSNID1 | 27,7 |
| | ON | EUA612ONNID1 | 17,3 |

HORIZONTAL | ORIZZONTALE | HORIZONTAL

PLATE AND HANDLES TRIMKIT
KIT PIASTRA E MANIGLIE
KIT PLAQUE ET POIGNÉE

| | | | |
|--|----|--------------|------|
| | CC | EUA622CCNID1 | 17,3 |
| | SS | EUA622SSNID1 | 21,6 |
| | NP | EUA622NPNID1 | 20,8 |
| | CF | EUA622CFNID1 | 26,0 |
| | CS | EUA622CSNID1 | 27,7 |
| | OO | EUA622OONID1 | 26,0 |
| | II | EUA622IINID1 | 26,0 |
| | IS | EUA622ISNID1 | 27,7 |
| | RS | EUA622RSNID1 | 26,0 |
| | SR | EUA622SRNID1 | 27,7 |
| | OS | EUA622OSNID1 | 27,7 |
| | ON | EUA622ONNID1 | 17,3 |

Bold



RECESSED BODY
CORPO INCASSO
PARTIE ENCASTRÉ
IUA002CCXN_1 8,8

PACKAGING

L: 530 mm
D: 145 mm
H: 90 mm
 4,16 kg

VERTICAL | VERTICALE | VERTICAL

PLATE AND HANDLES TRIMKIT
KIT PIASTRA E MANIGLIE
KIT PLAQUE ET POIGNÉE

| | | | |
|--|----|-------------|------|
| | CC | EUA612CCNB1 | 18,3 |
| | SS | EUA612SSNB1 | 22,9 |
| | NP | EUA612NPNB1 | 22,0 |
| | CF | EUA612CFNB1 | 27,5 |
| | CS | EUA612CSNB1 | 29,3 |
| | OO | EUA612OONB1 | 27,5 |
| | II | EUA612IINB1 | 27,5 |
| | IS | EUA612ISNB1 | 29,3 |
| | RS | EUA612RSNB1 | 27,5 |
| | SR | EUA612SRNB1 | 29,3 |
| | OS | EUA612OSNB1 | 29,3 |
| | ON | EUA612ONNB1 | 18,3 |

HORIZONTAL | ORIZZONTALE | HORIZONTAL

PLATE AND HANDLES TRIMKIT
KIT PIASTRA E MANIGLIE
KIT PLAQUE ET POIGNÉE

| | | | |
|--|----|-------------|------|
| | CC | EUA622CCNB1 | 18,3 |
| | SS | EUA622SSNB1 | 22,9 |
| | NP | EUA622NPNB1 | 22,0 |
| | CF | EUA622CFNB1 | 27,5 |
| | CS | EUA622CSNB1 | 29,3 |
| | OO | EUA622OONB1 | 27,5 |
| | II | EUA622IINB1 | 27,5 |
| | IS | EUA622ISNB1 | 29,3 |
| | RS | EUA622RSNB1 | 27,5 |
| | SR | EUA622SRNB1 | 29,3 |
| | OS | EUA622OSNB1 | 29,3 |
| | ON | EUA622ONNB1 | 18,3 |

Birkin



RECESSED BODY
CORPO INCASSO
PARTIE ENCASTRÉ
IUA002CCXN_1 8,8

PACKAGING

L: 530 mm
D: 145 mm
H: 90 mm
 4,16 kg

VERTICAL | VERTICALE | VERTICAL

PLATE AND HANDLES TRIMKIT
KIT PIASTRA E MANIGLIE
KIT PLAQUE ET POIGNÉE

| | | | |
|--|----|--------------|------|
| | CC | EUA612CCNBR3 | 22,3 |
| | SS | EUA612SSNBR3 | 27,9 |
| | RS | EUA612RSNBR3 | 33,5 |
| | OS | EUA612OSNBR3 | 35,7 |
| | PL | EUA612PLNBR3 | 35,7 |

HORIZONTAL | ORIZZONTALE | HORIZONTAL

PLATE AND HANDLES TRIMKIT
KIT PIASTRA E MANIGLIE
KIT PLAQUE ET POIGNÉE

| | | | |
|--|----|--------------|------|
| | CC | EUA622CCNBR3 | 22,3 |
| | SS | EUA622SSNBR3 | 27,9 |
| | RS | EUA622RSNBR3 | 33,5 |
| | OS | EUA622OSNBR3 | 35,7 |
| | PL | EUA622PLNBR3 | 35,7 |

Marmo



RECESSED BODY
CORPO INCASSO
PARTIE ENCASTRÉ
IUA002CCXN_1 8,8

PACKAGING

L: 530 mm
D: 145 mm
H: 90 mm
 4,24 kg

MARBLE

White Carrara
 Black Marquina

VERTICAL | VERTICALE | VERTICAL

PLATE AND HANDLES TRIMKIT
KIT PIASTRA E MANIGLIE
KIT PLAQUE ET POIGNÉE

| | | | | |
|--|----|--------------|--------------|------|
| | CC | EUA612CCNMR1 | EUA612CCNMR2 | 20,7 |
| | SS | EUA612SSNMR1 | EUA612SSNMR2 | 25,9 |
| | BO | EUA612BONMR1 | EUA612BONMR2 | 24,9 |
| | NP | EUA612NPNMR1 | EUA612NPNMR2 | 24,9 |
| | CF | EUA612CFNMR1 | EUA612CFNMR2 | 31,1 |
| | CS | EUA612CSNMR1 | EUA612CSNMR2 | 33,2 |
| | OO | EUA612OONMR1 | EUA612OONMR2 | 31,1 |
| | II | EUA612IINMR1 | EUA612IINMR2 | 31,1 |
| | IS | EUA612ISNMR1 | EUA612ISNMR2 | 33,2 |
| | RS | EUA612RSNMR1 | EUA612RSNMR2 | 31,1 |
| | SR | EUA612SRNMR1 | EUA612SRNMR2 | 33,2 |
| | OS | EUA612OSNMR1 | EUA612OSNMR2 | 33,2 |
| | ON | EUA612ONNMR1 | EUA612PLNMR2 | 20,7 |
| | PL | EUA612PLNMR1 | EUA612PLNMR2 | 33,2 |

HORIZONTAL | ORIZZONTALE | HORIZONTAL

PLATE AND HANDLES TRIMKIT
KIT PIASTRA E MANIGLIE
KIT PLAQUE ET POIGNÉE

| | | | | |
|--|----|--------------|--------------|------|
| | CC | EUA622CCNMR1 | EUA622CCNMR2 | 20,7 |
| | SS | EUA622SSNMR1 | EUA622SSNMR2 | 25,9 |
| | BO | EUA622BONMR1 | EUA622BONMR2 | 24,9 |
| | NP | EUA622NPNMR1 | EUA622NPNMR2 | 24,9 |
| | CF | EUA622CFNMR1 | EUA622CFNMR2 | 31,1 |
| | CS | EUA622CSNMR1 | EUA622CSNMR2 | 33,2 |
| | OO | EUA622OONMR1 | EUA622OONMR2 | 31,1 |
| | II | EUA622IINMR1 | EUA622IINMR2 | 31,1 |
| | IS | EUA622ISNMR1 | EUA622ISNMR2 | 33,2 |
| | RS | EUA622RSNMR1 | EUA622RSNMR2 | 31,1 |
| | SR | EUA622SRNMR1 | EUA622SRNMR2 | 33,2 |
| | OS | EUA622OSNMR1 | EUA622OSNMR2 | 33,2 |
| | ON | EUA622ONNMR1 | EUA622PLNMR2 | 20,7 |
| | PL | EUA622PLNMR1 | EUA622PLNMR2 | 33,2 |

Aqua

Rubacuori



RECESSED BODY
CORPO INCASSO
PARTIE ENCASTRÉ
IUA002CCXN_1 8,8

PACKAGING

L: 530 mm
D: 145 mm
H: 90 mm

4,16 kg



VERTICAL | VERTICALE | VERTICAL

PLATE AND HANDLES TRIMKIT
KIT PIASTRA E MANIGLIE
KIT PLAQUE ET POIGNÉE

| | | |
|----|-------------|------|
| CC | EUA611CCNRU | 17,3 |
| SS | EUA611SSNRU | 21,6 |
| BO | EUA611BONRU | 20,8 |
| NP | EUA611NPNRU | 20,8 |
| CF | EUA611CFNRU | 26,0 |
| CS | EUA611CSNRU | 27,7 |
| OO | EUA611OONRU | 26,0 |
| II | EUA611IINRU | 26,0 |
| IS | EUA611ISNRU | 27,7 |
| RS | EUA611RSNRU | 26,0 |
| SR | EUA611SRNRU | 27,7 |
| OS | EUA611OSNRU | 27,7 |

HORIZONTAL | ORIZZONTALE | HORIZONTAL

PLATE AND HANDLES TRIMKIT
KIT PIASTRA E MANIGLIE
KIT PLAQUE ET POIGNÉE

| | | |
|----|-------------|------|
| CC | EUA621CCNRU | 17,3 |
| SS | EUA621SSNRU | 21,6 |
| BO | EUA621BONRU | 20,8 |
| NP | EUA621NPNRU | 20,8 |
| CF | EUA621CFNRU | 26,0 |
| CS | EUA621CSNRU | 27,7 |
| OO | EUA621OONRU | 26,0 |
| II | EUA621IINRU | 26,0 |
| IS | EUA621ISNRU | 27,7 |
| RS | EUA621RSNRU | 26,0 |
| SR | EUA621SRNRU | 27,7 |
| OS | EUA621OSNRU | 27,7 |

Hey joe!



RECESSED BODY
CORPO INCASSO
PARTIE ENCASTRÉ
IUA002CCXN_1 8,8

PACKAGING

L: 530 mm
D: 145 mm
H: 90 mm

4,16 kg



VERTICAL | VERTICALE | VERTICAL

PLATE AND HANDLES TRIMKIT
KIT PIASTRA E MANIGLIE
KIT PLAQUE ET POIGNÉE

| | | |
|----|-------------|------|
| CC | EUA611CCNHJ | 17,3 |
| SS | EUA611SSNHJ | 21,6 |
| BO | EUA611BONHJ | 20,8 |
| NP | EUA611NPNHJ | 20,8 |
| CF | EUA611CFNHJ | 26,0 |
| CS | EUA611CSNHJ | 27,7 |
| OO | EUA611OONHJ | 26,0 |
| II | EUA611IINHJ | 26,0 |
| IS | EUA611ISNHJ | 27,7 |
| RS | EUA611RSNHJ | 26,0 |
| SR | EUA611SRNHJ | 27,7 |
| OS | EUA611OSNHJ | 27,7 |

HORIZONTAL | ORIZZONTALE | HORIZONTAL

PLATE AND HANDLES TRIMKIT
KIT PIASTRA E MANIGLIE
KIT PLAQUE ET POIGNÉE

| | | |
|----|-------------|------|
| CC | EUA621CCNHJ | 17,3 |
| SS | EUA621SSNHJ | 21,6 |
| BO | EUA621BONHJ | 20,8 |
| NP | EUA621NPNHJ | 20,8 |
| CF | EUA621CFNHJ | 26,0 |
| CS | EUA621CSNHJ | 27,7 |
| OO | EUA621OONHJ | 26,0 |
| II | EUA621IINHJ | 26,0 |
| IS | EUA621ISNHJ | 27,7 |
| RS | EUA621RSNHJ | 26,0 |
| SR | EUA621SRNHJ | 27,7 |
| OS | EUA621OSNHJ | 27,7 |

Belmondo



RECESSED BODY
CORPO INCASSO
PARTIE ENCASTRÉ
IUA002CCXN_1 8,8

PACKAGING

L: 530 mm
D: 145 mm
H: 90 mm

4,16 kg



VERTICAL | VERTICALE | VERTICAL

PLATE AND HANDLES TRIMKIT
KIT PIASTRA E MANIGLIE
KIT PLAQUE ET POIGNÉE

| | | |
|----|-------------|------|
| CC | EUA611CCNBT | 17,3 |
| OO | EUA611OONBT | 26,0 |
| II | EUA611IINBT | 26,0 |
| RS | EUA611RSNBT | 26,0 |
| PL | EUA611PLNBT | 27,7 |

HORIZONTAL | ORIZZONTALE | HORIZONTAL

PLATE AND HANDLES TRIMKIT
KIT PIASTRA E MANIGLIE
KIT PLAQUE ET POIGNÉE

| | | |
|----|-------------|------|
| CC | EUA621CCNBT | 17,3 |
| OO | EUA621OONBT | 26,0 |
| II | EUA621IINBT | 26,0 |
| RS | EUA621RSNBT | 26,0 |
| PL | EUA621PLNBT | 27,7 |

Kusasi



RECESSED BODY
CORPO INCASSO
PARTIE ENCASTRÉ
IUA002CCXN_1 8,8

PACKAGING

L: 530 mm
D: 145 mm
H: 90 mm

4,16 kg



VERTICAL | VERTICALE | VERTICAL

PLATE AND HANDLES TRIMKIT
KIT PIASTRA E MANIGLIE
KIT PLAQUE ET POIGNÉE

| | | |
|----|-------------|------|
| CC | EUA611CCNKU | 17,3 |
| SS | EUA611SSNKU | 21,6 |
| NP | EUA611NPNKU | 20,8 |

HORIZONTAL | ORIZZONTALE | HORIZONTAL

PLATE AND HANDLES TRIMKIT
KIT PIASTRA E MANIGLIE
KIT PLAQUE ET POIGNÉE

| | | |
|----|-------------|------|
| CC | EUA621CCNKU | 17,3 |
| SS | EUA621SSNKU | 21,6 |
| NP | EUA621NPNKU | 20,8 |

Wow



RECESSED BODY
CORPO INCASSO
PARTIE ENCASTRÉ
IUA002CCXN_1 8,8

PACKAGING

L: 530 mm
D: 145 mm
H: 90 mm

4,16 kg



VERTICAL | VERTICALE | VERTICAL

PLATE AND HANDLES TRIMKIT
KIT PIASTRA E MANIGLIE
KIT PLAQUE ET POIGNÉE

| | | |
|----|-------------|------|
| CC | EUA611CCNWO | 17,3 |
| SS | EUA611SSNWO | 21,6 |
| BO | EUA611BONWO | 20,8 |
| NP | EUA611NPNWO | 20,8 |
| OO | EUA611OONWO | 26,0 |

HORIZONTAL | ORIZZONTALE | HORIZONTAL

PLATE AND HANDLES TRIMKIT
KIT PIASTRA E MANIGLIE
KIT PLAQUE ET POIGNÉE

| | | |
|----|-------------|------|
| CC | EUA621CCNWO | 17,3 |
| SS | EUA621SSNWO | 21,6 |
| BO | EUA621BONWO | 20,8 |
| NP | EUA621NPNWO | 20,8 |
| OO | EUA621OONWO | 26,0 |

Industria



RECESSED BODY
CORPO INCASSO
PARTIE ENCASTRÉ
IUA002CCXN_1 8,8

PACKAGING

L: 530 mm
D: 145 mm
H: 90 mm

4,16 kg

VERTICAL | VERTICALE | VERTICAL

PLATE AND HANDLES TRIMKIT
KIT PIASTRA E MANIGLIE
KIT PLAQUE ET POIGNÉE

| | | |
|----|--------------|------|
| CC | EUA611CCNID1 | 17,3 |
| SS | EUA611SSNID1 | 21,6 |
| NP | EUA611NPNID1 | 20,8 |
| CF | EUA611CFNID1 | 26,0 |
| CS | EUA611CSNID1 | 27,7 |
| OO | EUA611OONID1 | 26,0 |
| II | EUA611IINID1 | 26,0 |
| IS | EUA611ISNID1 | 27,7 |
| RS | EUA611RSNID1 | 26,0 |
| SR | EUA611SRNID1 | 27,7 |
| OS | EUA611OSNID1 | 27,7 |
| ON | EUA611ONNID1 | 17,3 |

HORIZONTAL | ORIZZONTALE | HORIZONTAL

PLATE AND HANDLES TRIMKIT
KIT PIASTRA E MANIGLIE
KIT PLAQUE ET POIGNÉE

| | | |
|----|--------------|------|
| CC | EUA621CCNID1 | 17,3 |
| SS | EUA621SSNID1 | 21,6 |
| NP | EUA621NPNID1 | 20,8 |
| CF | EUA621CFNID1 | 26,0 |
| CS | EUA621CSNID1 | 27,7 |
| OO | EUA621OONID1 | 26,0 |
| II | EUA621IINID1 | 26,0 |
| IS | EUA621ISNID1 | 27,7 |
| RS | EUA621RSNID1 | 26,0 |
| SR | EUA621SRNID1 | 27,7 |
| OS | EUA621OSNID1 | 27,7 |
| ON | EUA621ONNID1 | 17,3 |

Marmo



RECESSED BODY
CORPO INCASSO
PARTIE ENCASTRÉ
IUA002CCXN_1 8,8

PACKAGING

L: 530 mm
D: 145 mm
H: 90 mm

4,24 kg

MARBLE

White Carrara

Black Marquina

VERTICAL | VERTICALE | VERTICAL

PLATE AND HANDLES TRIMKIT
KIT PIASTRA E MANIGLIE
KIT PLAQUE ET POIGNÉE

| | | | |
|----|--------------|--------------|------|
| CC | EUA611CCNMR1 | EUA611CCNMR2 | 20,7 |
| SS | EUA611SSNMR1 | EUA611SSNMR2 | 25,9 |
| BO | EUA611BONMR1 | EUA611BONMR2 | 24,9 |
| NP | EUA611NPNMR1 | EUA611NPNMR2 | 24,9 |
| CF | EUA611CFNMR1 | EUA611CFNMR2 | 31,1 |
| CS | EUA611CSNMR1 | EUA611CSNMR2 | 33,2 |
| OO | EUA611OONMR1 | EUA611OONMR2 | 31,1 |
| II | EUA611IINMR1 | EUA611IINMR2 | 31,1 |
| IS | EUA611ISNMR1 | EUA611ISNMR2 | 33,2 |
| RS | EUA611RSNMR1 | EUA611RSNMR2 | 31,1 |
| SR | EUA611SRNMR1 | EUA611SRNMR2 | 33,2 |
| OS | EUA611OSNMR1 | EUA611OSNMR2 | 33,2 |
| ON | EUA611ONNMR1 | EUA611PLNMR2 | 20,7 |
| PL | EUA611PLNMR1 | EUA611PLNMR2 | 33,2 |

HORIZONTAL | ORIZZONTALE | HORIZONTAL

PLATE AND HANDLES TRIMKIT
KIT PIASTRA E MANIGLIE
KIT PLAQUE ET POIGNÉE

| | | | |
|----|--------------|--------------|------|
| CC | EUA621CCNMR1 | EUA621CCNMR2 | 20,7 |
| SS | EUA621SSNMR1 | EUA621SSNMR2 | 25,9 |
| BO | EUA621BONMR1 | EUA621BONMR2 | 24,9 |
| NP | EUA621NPNMR1 | EUA621NPNMR2 | 24,9 |
| CF | EUA621CFNMR1 | EUA621CFNMR2 | 31,1 |
| CS | EUA621CSNMR1 | EUA621CSNMR2 | 33,2 |
| OO | EUA621OONMR1 | EUA621OONMR2 | 31,1 |
| II | EUA621IINMR1 | EUA621IINMR2 | 31,1 |
| IS | EUA621ISNMR1 | EUA621ISNMR2 | 33,2 |
| RS | EUA621RSNMR1 | EUA621RSNMR2 | 31,1 |
| SR | EUA621SRNMR1 | EUA621SRNMR2 | 33,2 |
| OS | EUA621OSNMR1 | EUA621OSNMR2 | 33,2 |
| ON | EUA621ONNMR1 | EUA621PLNMR2 | 20,7 |
| PL | EUA621PLNMR1 | EUA621PLNMR2 | 33,2 |

Hermes



RECESSED BODY
CORPO INCASSO
PARTIE ENCASTRÉ
IUA002CCXN_1 8,8

PACKAGING

L: 530 mm
D: 145 mm
H: 90 mm

4,16 kg

VERTICAL | VERTICALE | VERTICAL

PLATE AND HANDLES TRIMKIT
KIT PIASTRA E MANIGLIE
KIT PLAQUE ET POIGNÉE

| | | |
|----|-------------|------|
| CC | EUA615CCNHR | 17,4 |
| SS | EUA615SSNHR | 21,8 |
| II | EUA615IINHR | 26,1 |
| RS | EUA615RSNHR | 26,1 |
| OS | EUA615OSNHR | 27,9 |
| RR | EUA615RRNHR | 24,4 |
| BB | EUA615BBNHR | 24,4 |
| PL | EUA615PLNHR | 27,9 |

HORIZONTAL | ORIZZONTALE | HORIZONTAL

PLATE AND HANDLES TRIMKIT
KIT PIASTRA E MANIGLIE
KIT PLAQUE ET POIGNÉE

| | | |
|----|-------------|------|
| CC | EUA625CCNHR | 17,4 |
| SS | EUA625SSNHR | 21,8 |
| II | EUA625IINHR | 26,1 |
| RS | EUA625RSNHR | 26,1 |
| OS | EUA625OSNHR | 27,9 |
| RR | EUA625RRNHR | 24,4 |
| BB | EUA625BBNHR | 24,4 |
| PL | EUA625PLNHR | 27,9 |

Birkin



RECESSED BODY
CORPO INCASSO
PARTIE ENCASTRÉ
IUA002CCXN_1 8,8

PACKAGING

L: 530 mm
D: 145 mm
H: 90 mm

4,16 kg

VERTICAL | VERTICALE | VERTICAL

PLATE AND HANDLES TRIMKIT
KIT PIASTRA E MANIGLIE
KIT PLAQUE ET POIGNÉE

| | | |
|----|--------------|------|
| CC | EUA615CCNBR3 | 22,3 |
| SS | EUA615SSNBR3 | 27,9 |
| RS | EUA615RSNBR3 | 33,5 |
| OS | EUA615OSNBR3 | 35,7 |
| PL | EUA615PLNBR3 | 35,7 |

HORIZONTAL | ORIZZONTALE | HORIZONTAL

PLATE AND HANDLES TRIMKIT
KIT PIASTRA E MANIGLIE
KIT PLAQUE ET POIGNÉE

| | | |
|----|--------------|------|
| CC | EUA625CCNBR3 | 22,3 |
| SS | EUA625SSNBR3 | 27,9 |
| RS | EUA625RSNBR3 | 33,5 |
| OS | EUA625OSNBR3 | 35,7 |
| PL | EUA625PLNBR3 | 35,7 |

Aqua

AQUA

Diverter 3 ways

3 vie con deviatore
3 voies avec déviateur

ARTICLE | ARTICOLO | ARTICLE

IUA003CCXN_1

Only the built-in 1½" thermostatic unit of compact size, horizontal / vertical installation
Solo parte incasso termostatico 1/2 " ingombro ridotto, installazione orizzontale / verticale.
Seulement partie encastré du thermostatique 1/2" économie d'espace, installation horizontale / vertical.

CODE / COEFFICIENT | CODICE / COEFFICIENTE | CODE / COEFFICIENT

9,4

TECHNICAL DATA

Minimum dynamic pressure 0,5 bar
Maximum operational pressure 5 bar
Recommended operational pressure da 1 a 5 bar
Maximum hot water temperature 80°C

GENERAL FEATURES

Installation depth from 80 mm to 90 mm.
The intakes are fitted with G1/2" female G3/4" male, threaded connection, the outlets only G1/2"F (1, 2 or 3 way).
The temperature regulator lever is pre-set at 38°C.
Use of a pressure reducer is recommended if pressures in the system exceed 5 bar.

DATI TECNICI

Pressione dinamica minima 0,5 bar
Pressione di esercizio massima 5 bar
Pressione di utilizzo raccomandata da 1 a 5 bar
Temperatura massima acqua calda 80°C

CARATTERISTICHE GENERALI

Profondità di installazione da 80 mm a 90 mm.
Le entrate vengono fornite con filetto G1/2" femmina G3/4" maschio, le uscite solo G1/2"F (1, 2 o 3 vie).
La maniglia di regolazione temperatura, viene pre-settata a 38°C.
Si raccomanda l'utilizzo di un riduttore di pressione, se all'interno dell'impianto, si hanno pressioni superiori a 5 bar.

DONNÉES TECHNIQUES

Pression dynamique minimum 0,5 bar
Pression de service maximale de 5 bar
Pression d'utilisation conseillé de 1 à 5 bar
Température maximale de l'eau chaude 80 ° C

CARACTERISTIQUES GENERALES

Profondeur de montage de 80 mm à 90 mm.
Les entrées sont fournis avec filetage G1/2" femelle G3/4" mâle, les sorties G1/2"F (1,2,ou 3 voies).
La poignée de réglage de la température, est pré-réglée à 38 ° C Si à l'intérieur du système vous avez des pressions supérieures à 5 bars, il est recommandé l'utilisation d'un réducteur de pression.

Built-in part - Parte incasso - Corps encastré

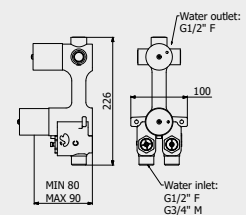

Plate and handles - Parte esterna - Plaque et poignée

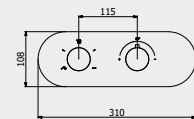
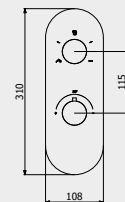

Plate and handles - Parte esterna - Plaque et poignée



PACKAGING

L: 240 mm D: 115 mm H: 160 mm 3,4 kg

ORIENTATION | ORIENTAZIONE | ORIENTATION

2 ways to installation: horizontal or vertical
2 modalità di installazione: verticale o orizzontale
2 modalités de installation: vertical ou horizontal.

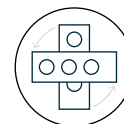

FOR ALL MODELS
PER TUTTI I MODELLI
POUR TOUS LES MODÈLES





A Mixed water outlet
Uscita acqua miscelata
Sortie eau mélangé



B Mixed water outlet
Uscita acqua miscelata
Sortie eau mélangé



C Mixed water outlet
Uscita acqua miscelata
Sortie eau mélangé



H Hot water
Acqua calda
Eau chaude



C Cold water
Acqua fredda
Eau froide

Aqua

PORTATE | WATER FLOW | DÉBIT D'EAU

| 0.2 BAR | 0.5 BAR | 1 BAR | 2 BAR | 3 BAR | 4 BAR | 5 BAR |
|----------|---------|--------|--------|--------|--------|--------|
| 10,7 l/m | 18 l/m | 26 l/m | 37 l/m | 45 l/m | 51 l/m | 56 l/m |

Hey Joe!



RECESSED BODY
CORPO INCASSO
PARTIE ENCASTRÉ
IUA003CCXN_1 9,4

PACKAGING

L: 530 mm
D: 145 mm
H: 90 mm

4,16 kg



VERTICAL | VERTICALE | VERTICAL

| PLATE AND HANDLES TRIMKIT KIT PIASTRA E MANIGLIE KIT PLAQUE ET POIGNÉE | | |
|--|-------------|------|
| CC | EUA712CCNHJ | 17,3 |
| SS | EUA712SSNHJ | 21,6 |
| BO | EUA712BONHJ | 20,8 |
| NP | EUA712NPNHJ | 20,8 |
| CF | EUA712CFNHJ | 26,0 |
| CS | EUA712CSNHJ | 27,7 |
| OO | EUA712OONHJ | 26,0 |
| II | EUA712IINHJ | 26,0 |
| IS | EUA712ISNHJ | 27,7 |
| RS | EUA712RSNHJ | 26,0 |
| SR | EUA712SRNHJ | 27,7 |
| OS | EUA712OSNHJ | 27,7 |

HORIZONTAL | ORIZZONTALE | HORIZONTAL

| PLATE AND HANDLES TRIMKIT KIT PIASTRA E MANIGLIE KIT PLAQUE ET POIGNÉE | | |
|--|-------------|------|
| CC | EUA722CCNHJ | 17,3 |
| SS | EUA722SSNHJ | 21,6 |
| BO | EUA722BONHJ | 20,8 |
| NP | EUA722NPNHJ | 20,8 |
| CF | EUA722CFNHJ | 26,0 |
| CS | EUA722CSNHJ | 27,7 |
| OO | EUA722OONHJ | 26,0 |
| II | EUA722IINHJ | 26,0 |
| IS | EUA722ISNHJ | 27,7 |
| RS | EUA722RSNHJ | 26,0 |
| SR | EUA722SRNHJ | 27,7 |
| OS | EUA722OSNHJ | 27,7 |

Loveme



RECESSED BODY
CORPO INCASSO
PARTIE ENCASTRÉ
IUA003CCXN_1 9,4

PACKAGING

L: 530 mm
D: 145 mm
H: 90 mm

4,16 kg



VERTICAL | VERTICALE | VERTICAL

| PLATE AND HANDLES TRIMKIT KIT PIASTRA E MANIGLIE KIT PLAQUE ET POIGNÉE | | |
|--|-------------|------|
| CC | EUA712CCNLM | 17,3 |
| SS | EUA712SSNLM | 21,6 |
| BO | EUA712BONLM | 20,8 |
| NP | EUA712NPNLM | 20,8 |
| CS | EUA712CSNLM | 27,7 |
| IS | EUA712ISNLM | 27,7 |
| SR | EUA712SRNLM | 27,7 |
| OS | EUA712OSNLM | 27,7 |
| ON | EUA712ONNLM | 17,3 |

HORIZONTAL | ORIZZONTALE | HORIZONTAL

| PLATE AND HANDLES TRIMKIT KIT PIASTRA E MANIGLIE KIT PLAQUE ET POIGNÉE | | |
|--|-------------|------|
| CC | EUA722CCNLM | 17,3 |
| SS | EUA722SSNLM | 21,6 |
| BO | EUA722BONLM | 20,8 |
| NP | EUA722NPNLM | 20,8 |
| CS | EUA722CSNLM | 27,7 |
| IS | EUA722ISNLM | 27,7 |
| SR | EUA722SRNLM | 27,7 |
| OS | EUA722OSNLM | 27,7 |
| ON | EUA722ONNLM | 17,3 |

Belmondo



RECESSED BODY
CORPO INCASSO
PARTIE ENCASTRÉ
IUA003CCXN_1 9,4

PACKAGING

L: 530 mm
D: 145 mm
H: 90 mm

4,16 kg



VERTICAL | VERTICALE | VERTICAL

| PLATE AND HANDLES TRIMKIT KIT PIASTRA E MANIGLIE KIT PLAQUE ET POIGNÉE | | |
|--|-------------|------|
| CC | EUA712CCNBT | 17,3 |
| OO | EUA712OONBT | 26,0 |
| II | EUA712IINBT | 26,0 |
| RS | EUA712RSNBT | 26,0 |
| PL | EUA712PLNBT | 27,7 |

HORIZONTAL | ORIZZONTALE | HORIZONTAL

| PLATE AND HANDLES TRIMKIT KIT PIASTRA E MANIGLIE KIT PLAQUE ET POIGNÉE | | |
|--|-------------|------|
| CC | EUA722CCNBT | 17,3 |
| OO | EUA722OONBT | 26,0 |
| II | EUA722IINBT | 26,0 |
| RS | EUA722RSNBT | 26,0 |
| PL | EUA722PLNBT | 27,7 |

Batlò



RECESSED BODY
CORPO INCASSO
PARTIE ENCASTRÉ
IUA003CCXN_1 9,4

PACKAGING

L: 530 mm
D: 145 mm
H: 90 mm

4,16 kg



VERTICAL | VERTICALE | VERTICAL

| PLATE AND HANDLES TRIMKIT KIT PIASTRA E MANIGLIE KIT PLAQUE ET POIGNÉE | | |
|--|-------------|------|
| CC | EUA712CCNBI | 17,3 |
| SS | EUA712SSNBI | 21,6 |
| BO | EUA712BONBI | 20,8 |
| NP | EUA712NPNBI | 20,8 |
| CF | EUA712CFNBI | 26,0 |
| CS | EUA712CSNBI | 27,7 |
| OO | EUA712OONBI | 26,0 |
| II | EUA712IINBI | 26,0 |
| IS | EUA712ISNBI | 27,7 |
| RS | EUA712RSNBI | 26,0 |
| SR | EUA712SRNBI | 27,7 |
| OS | EUA712OSNBI | 27,7 |

HORIZONTAL | ORIZZONTALE | HORIZONTAL

| PLATE AND HANDLES TRIMKIT KIT PIASTRA E MANIGLIE KIT PLAQUE ET POIGNÉE | | |
|--|-------------|------|
| CC | EUA722CCNBI | 17,3 |
| SS | EUA722SSNBI | 21,6 |
| BO | EUA722BONBI | 20,8 |
| NP | EUA722NPNBI | 20,8 |
| CF | EUA722CFNBI | 26,0 |
| CS | EUA722CSNBI | 27,7 |
| OO | EUA722OONBI | 26,0 |
| II | EUA722IINBI | 26,0 |
| IS | EUA722ISNBI | 27,7 |
| RS | EUA722RSNBI | 26,0 |
| SR | EUA722SRNBI | 27,7 |
| OS | EUA722OSNBI | 27,7 |

Kusasi



RECESSED BODY
CORPO INCASSO
PARTIE ENCASTRÉ
IUA003CCXN_1 9,4

PACKAGING

L: 530 mm
D: 145 mm
H: 90 mm

4,16 kg



VERTICAL | VERTICALE | VERTICAL

| PLATE AND HANDLES TRIMKIT KIT PIASTRA E MANIGLIE KIT PLAQUE ET POIGNÉE | | |
|--|-------------|------|
| CC | EUA712CCNKU | 17,3 |
| SS | EUA712SSNKU | 21,6 |
| NP | EUA712NPNKU | 20,8 |

HORIZONTAL | ORIZZONTALE | HORIZONTAL

| PLATE AND HANDLES TRIMKIT KIT PIASTRA E MANIGLIE KIT PLAQUE ET POIGNÉE | | |
|--|-------------|------|
| CC | EUA722CCNKU | 17,3 |
| SS | EUA722SSNKU | 21,6 |
| NP | EUA722NPNKU | 20,8 |

Wow

RECESSED BODY
CORPO INCASSO
PARTIE ENCASTRÉ

IUA003CCXN_1 9,4



PACKAGING

 L: 530 mm
D: 145 mm
H: 90 mm

 4,16 kg

VERTICAL | VERTICALE | VERTICAL

PLATE AND HANDLES TRIMKIT
KIT PIASTRA E MANIGLIE
KIT PLAQUE ET POIGNÉE

| | | |
|----|-------------|------|
| CC | EUA712CCNWO | 17,3 |
| SS | EUA712SSNWO | 21,6 |
| BO | EUA712BONWO | 20,8 |
| NP | EUA712NPNWO | 20,8 |
| OO | EUA712OONWO | 26,0 |

HORIZONTAL | ORIZZONTALE | HORIZONTAL

PLATE AND HANDLES TRIMKIT
KIT PIASTRA E MANIGLIE
KIT PLAQUE ET POIGNÉE

| | | |
|----|-------------|------|
| CC | EUA722CCNWO | 17,3 |
| SS | EUA722SSNWO | 21,6 |
| BO | EUA722BONWO | 20,8 |
| NP | EUA722NPNWO | 20,8 |
| OO | EUA722OONWO | 26,0 |

Industria

RECESSED BODY
CORPO INCASSO
PARTIE ENCASTRÉ

IUA003CCXN_1 9,4



PACKAGING

 L: 530 mm
D: 145 mm
H: 90 mm

 4,16 kg

VERTICAL | VERTICALE | VERTICAL

PLATE AND HANDLES TRIMKIT
KIT PIASTRA E MANIGLIE
KIT PLAQUE ET POIGNÉE

| | | |
|----|--------------|------|
| CC | EUA712CCNID1 | 17,3 |
| SS | EUA712SSNID1 | 21,6 |
| NP | EUA712NPNID1 | 20,8 |
| CF | EUA712CFNID1 | 26,0 |
| CS | EUA712CSNID1 | 27,7 |
| OO | EUA712OONID1 | 26,0 |
| II | EUA712IINID1 | 26,0 |
| IS | EUA712ISNID1 | 27,7 |
| RS | EUA712RSNID1 | 26,0 |
| SR | EUA712SRNID1 | 27,7 |
| OS | EUA712OSNID1 | 27,7 |
| ON | EUA712ONNID1 | 17,3 |

HORIZONTAL | ORIZZONTALE | HORIZONTAL

PLATE AND HANDLES TRIMKIT
KIT PIASTRA E MANIGLIE
KIT PLAQUE ET POIGNÉE

| | | |
|----|--------------|------|
| CC | EUA722CCNID1 | 17,3 |
| SS | EUA722SSNID1 | 21,6 |
| NP | EUA722NPNID1 | 20,8 |
| CF | EUA722CFNID1 | 26,0 |
| CS | EUA722CSNID1 | 27,7 |
| OO | EUA722OONID1 | 26,0 |
| II | EUA722IINID1 | 26,0 |
| IS | EUA722ISNID1 | 27,7 |
| RS | EUA722RSNID1 | 26,0 |
| SR | EUA722SRNID1 | 27,7 |
| OS | EUA722OSNID1 | 27,7 |
| ON | EUA722ONNID1 | 17,3 |

Bold

RECESSED BODY
CORPO INCASSO
PARTIE ENCASTRÉ

IUA003CCXN_1 9,4



PACKAGING

 L: 530 mm
D: 145 mm
H: 90 mm

 4,16 kg

VERTICAL | VERTICALE | VERTICAL

PLATE AND HANDLES TRIMKIT
KIT PIASTRA E MANIGLIE
KIT PLAQUE ET POIGNÉE

| | | |
|----|-------------|------|
| CC | EUA712CCNB1 | 18,3 |
| SS | EUA712SSNB1 | 22,9 |
| NP | EUA712NPNB1 | 22,0 |
| CF | EUA712CFNB1 | 27,5 |
| CS | EUA712CSNB1 | 29,3 |
| OO | EUA712OONB1 | 27,5 |
| II | EUA712IINB1 | 27,5 |
| IS | EUA712ISNB1 | 29,3 |
| RS | EUA712RSNB1 | 27,5 |
| SR | EUA712SRNB1 | 29,3 |
| OS | EUA712OSNB1 | 29,3 |
| ON | EUA712ONNB1 | 18,3 |

HORIZONTAL | ORIZZONTALE | HORIZONTAL

PLATE AND HANDLES TRIMKIT
KIT PIASTRA E MANIGLIE
KIT PLAQUE ET POIGNÉE

| | | |
|----|-------------|------|
| CC | EUA722CCNB1 | 18,3 |
| SS | EUA722SSNB1 | 22,9 |
| NP | EUA722NPNB1 | 22,0 |
| CF | EUA722CFNB1 | 27,5 |
| CS | EUA722CSNB1 | 29,3 |
| OO | EUA722OONB1 | 27,5 |
| II | EUA722IINB1 | 27,5 |
| IS | EUA722ISNB1 | 29,3 |
| RS | EUA722RSNB1 | 27,5 |
| SR | EUA722SRNB1 | 29,3 |
| OS | EUA722OSNB1 | 29,3 |
| ON | EUA722ONNB1 | 18,3 |

Birkin

RECESSED BODY
CORPO INCASSO
PARTIE ENCASTRÉ

IUA003CCXN_1 9,4



PACKAGING

 L: 530 mm
D: 145 mm
H: 90 mm

 4,16 kg

VERTICAL | VERTICALE | VERTICAL

PLATE AND HANDLES TRIMKIT
KIT PIASTRA E MANIGLIE
KIT PLAQUE ET POIGNÉE

| | | |
|----|--------------|------|
| CC | EUA712CCNBR3 | 22,3 |
| SS | EUA712SSNBR3 | 27,9 |
| RS | EUA712RSNBR3 | 33,5 |
| OS | EUA712OSNBR3 | 35,7 |
| PL | EUA712PLNBR3 | 35,7 |

HORIZONTAL | ORIZZONTALE | HORIZONTAL

PLATE AND HANDLES TRIMKIT
KIT PIASTRA E MANIGLIE
KIT PLAQUE ET POIGNÉE

| | | |
|----|--------------|------|
| CC | EUA722CCNBR3 | 22,3 |
| SS | EUA722SSNBR3 | 27,9 |
| RS | EUA722RSNBR3 | 33,5 |
| OS | EUA722OSNBR3 | 35,7 |
| PL | EUA722PLNBR3 | 35,7 |

Marmo

RECESSED BODY
CORPO INCASSO
PARTIE ENCASTRÉ

IUA003CCXN_1 9,4



PACKAGING

 L: 530 mm
D: 145 mm
H: 90 mm

 4,24 kg

MARBLE

 White Carrara

 Black Marquina

VERTICAL | VERTICALE | VERTICAL

PLATE AND HANDLES TRIMKIT
KIT PIASTRA E MANIGLIE
KIT PLAQUE ET POIGNÉE

| | | | |
|----|--------------|--------------|------|
| CC | EUA712CCNMR1 | EUA712CCNMR2 | 20,7 |
| SS | EUA712SSNMR1 | EUA712SSNMR2 | 25,9 |
| BO | EUA712BONMR1 | EUA712BONMR2 | 24,9 |
| NP | EUA712NPNMR1 | EUA712NPNMR2 | 24,9 |
| CF | EUA712CFNMR1 | EUA712CFNMR2 | 31,1 |
| CS | EUA712CSNMR1 | EUA712CSNMR2 | 33,2 |
| OO | EUA712OONMR1 | EUA712OONMR2 | 31,1 |
| II | EUA712IINMR1 | EUA712IINMR2 | 31,1 |
| IS | EUA712ISNMR1 | EUA712ISNMR2 | 33,2 |
| RS | EUA712RSNMR1 | EUA712RSNMR2 | 31,1 |
| SR | EUA712SRNMR1 | EUA712SRNMR2 | 33,2 |
| OS | EUA712OSNMR1 | EUA712OSNMR2 | 33,2 |
| ON | EUA712ONNMR1 | EUA712PLNMR2 | 20,7 |
| PL | EUA712PLNMR1 | EUA712PLNMR2 | 33,2 |

HORIZONTAL | ORIZZONTALE | HORIZONTAL

PLATE AND HANDLES TRIMKIT
KIT PIASTRA E MANIGLIE
KIT PLAQUE ET POIGNÉE

| | | | |
|----|--------------|--------------|------|
| CC | EUA722CCNMR1 | EUA722CCNMR2 | 20,7 |
| SS | EUA722SSNMR1 | EUA722SSNMR2 | 25,9 |
| BO | EUA722BONMR1 | EUA722BONMR2 | 24,9 |
| NP | EUA722NPNMR1 | EUA722NPNMR2 | 24,9 |
| CF | EUA722CFNMR1 | EUA722CFNMR2 | 31,1 |
| CS | EUA722CSNMR1 | EUA722CSNMR2 | 33,2 |
| OO | EUA722OONMR1 | EUA722OONMR2 | 31,1 |
| II | EUA722IINMR1 | EUA722IINMR2 | 31,1 |
| IS | EUA722ISNMR1 | EUA722ISNMR2 | 33,2 |
| RS | EUA722RSNMR1 | EUA722RSNMR2 | 31,1 |
| SR | EUA722SRNMR1 | EUA722SRNMR2 | 33,2 |
| OS | EUA722OSNMR1 | EUA722OSNMR2 | 33,2 |
| ON | EUA722ONNMR1 | EUA722PLNMR2 | 20,7 |
| PL | EUA722PLNMR1 | EUA722PLNMR2 | 33,2 |

Aqua

Rubacuori



RECESSED BODY
CORPO INCASSO
PARTIE ENCASTRÉ
IUA003CCXN_1 9,4

PACKAGING

L: 530 mm
D: 145 mm
H: 90 mm

4,16 kg



VERTICAL | VERTICALE | VERTICAL

PLATE AND HANDLES TRIMKIT
KIT PIASTRÀ E MANIGLIE
KIT PLAQUE ET POIGNÉE

| | | |
|----|-------------|------|
| CC | EUA711CCNRU | 17,3 |
| SS | EUA711SSNRU | 21,6 |
| BO | EUA711BONRU | 20,8 |
| NP | EUA711NPNRU | 20,8 |
| CF | EUA711CFNRU | 26,0 |
| CS | EUA711CSNRU | 27,7 |
| OO | EUA711OONRU | 26,0 |
| II | EUA711IINRU | 26,0 |
| IS | EUA711ISNRU | 27,7 |
| RS | EUA711RSNRU | 26,0 |
| SR | EUA711SRNRU | 27,7 |
| OS | EUA711OSNRU | 27,7 |

HORIZONTAL | ORIZZONTALE | HORIZONTAL

PLATE AND HANDLES TRIMKIT
KIT PIASTRÀ E MANIGLIE
KIT PLAQUE ET POIGNÉE

| | | |
|----|-------------|------|
| CC | EUA721CCNRU | 17,3 |
| SS | EUA721SSNRU | 21,6 |
| BO | EUA721BONRU | 20,8 |
| NP | EUA721NPNRU | 20,8 |
| CF | EUA721CFNRU | 26,0 |
| CS | EUA721CSNRU | 27,7 |
| OO | EUA721OONRU | 26,0 |
| II | EUA721IINRU | 26,0 |
| IS | EUA721ISNRU | 27,7 |
| RS | EUA721RSNRU | 26,0 |
| SR | EUA721SRNRU | 27,7 |
| OS | EUA721OSNRU | 27,7 |

Hey joe!



RECESSED BODY
CORPO INCASSO
PARTIE ENCASTRÉ
IUA003CCXN_1 9,4

PACKAGING

L: 530 mm
D: 145 mm
H: 90 mm

4,16 kg



VERTICAL | VERTICALE | VERTICAL

PLATE AND HANDLES TRIMKIT
KIT PIASTRÀ E MANIGLIE
KIT PLAQUE ET POIGNÉE

| | | |
|----|-------------|------|
| CC | EUA711CCNHJ | 17,3 |
| SS | EUA711SSNHJ | 21,6 |
| BO | EUA711BONHJ | 20,8 |
| NP | EUA711NPNHJ | 20,8 |
| CF | EUA711CFNHJ | 26,0 |
| CS | EUA711CSNHJ | 27,7 |
| OO | EUA711OONHJ | 26,0 |
| II | EUA711IINHJ | 26,0 |
| IS | EUA711ISNHJ | 27,7 |
| RS | EUA711RSNHJ | 26,0 |
| SR | EUA711SRNHJ | 27,7 |
| OS | EUA711OSNHJ | 27,7 |

HORIZONTAL | ORIZZONTALE | HORIZONTAL

PLATE AND HANDLES TRIMKIT
KIT PIASTRÀ E MANIGLIE
KIT PLAQUE ET POIGNÉE

| | | |
|----|-------------|------|
| CC | EUA721CCNHJ | 17,3 |
| SS | EUA721SSNHJ | 21,6 |
| BO | EUA721BONHJ | 20,8 |
| NP | EUA721NPNHJ | 20,8 |
| CF | EUA721CFNHJ | 26,0 |
| CS | EUA721CSNHJ | 27,7 |
| OO | EUA721OONHJ | 26,0 |
| II | EUA721IINHJ | 26,0 |
| IS | EUA721ISNHJ | 27,7 |
| RS | EUA721RSNHJ | 26,0 |
| SR | EUA721SRNHJ | 27,7 |
| OS | EUA721OSNHJ | 27,7 |

Belmondo



RECESSED BODY
CORPO INCASSO
PARTIE ENCASTRÉ
IUA003CCXN_1 9,4

PACKAGING

L: 530 mm
D: 145 mm
H: 90 mm

4,16 kg



VERTICAL | VERTICALE | VERTICAL

PLATE AND HANDLES TRIMKIT
KIT PIASTRÀ E MANIGLIE
KIT PLAQUE ET POIGNÉE

| | | |
|----|-------------|------|
| CC | EUA711CCNBT | 17,3 |
| OO | EUA711OONBT | 26,0 |
| II | EUA711IINBT | 26,0 |
| RS | EUA711RSNBT | 26,0 |
| PL | EUA711PLNBT | 27,7 |

HORIZONTAL | ORIZZONTALE | HORIZONTAL

PLATE AND HANDLES TRIMKIT
KIT PIASTRÀ E MANIGLIE
KIT PLAQUE ET POIGNÉE

| | | |
|----|-------------|------|
| CC | EUA721CCNBT | 17,3 |
| OO | EUA721OONBT | 26,0 |
| II | EUA721IINBT | 26,0 |
| RS | EUA721RSNBT | 26,0 |
| PL | EUA721PLNBT | 27,7 |

Kusasi



RECESSED BODY
CORPO INCASSO
PARTIE ENCASTRÉ
IUA003CCXN_1 9,4

PACKAGING

L: 530 mm
D: 145 mm
H: 90 mm

4,16 kg



VERTICAL | VERTICALE | VERTICAL

PLATE AND HANDLES TRIMKIT
KIT PIASTRÀ E MANIGLIE
KIT PLAQUE ET POIGNÉE

| | | |
|----|-------------|------|
| CC | EUA711CCNKU | 17,3 |
| SS | EUA711SSNKU | 21,6 |
| NP | EUA711NPNKU | 20,8 |

HORIZONTAL | ORIZZONTALE | HORIZONTAL

PLATE AND HANDLES TRIMKIT
KIT PIASTRÀ E MANIGLIE
KIT PLAQUE ET POIGNÉE

| | | |
|----|-------------|------|
| CC | EUA721CCNKU | 17,3 |
| SS | EUA721SSNKU | 21,6 |
| NP | EUA721NPNKU | 20,8 |

Wow



RECESSED BODY
CORPO INCASSO
PARTIE ENCASTRÉ
IUA003CCXN_1 9,4

PACKAGING

L: 530 mm
D: 145 mm
H: 90 mm

4,16 kg



VERTICAL | VERTICALE | VERTICAL

PLATE AND HANDLES TRIMKIT
KIT PIASTRÀ E MANIGLIE
KIT PLAQUE ET POIGNÉE

| | | |
|----|-------------|------|
| CC | EUA711CCNWO | 17,3 |
| SS | EUA711SSNWO | 21,6 |
| BO | EUA711BONWO | 20,8 |
| NP | EUA711NPNWO | 20,8 |
| OO | EUA711OONWO | 26,0 |

HORIZONTAL | ORIZZONTALE | HORIZONTAL

PLATE AND HANDLES TRIMKIT
KIT PIASTRÀ E MANIGLIE
KIT PLAQUE ET POIGNÉE

| | | |
|----|-------------|------|
| CC | EUA721CCNWO | 17,3 |
| SS | EUA721SSNWO | 21,6 |
| BO | EUA721BONWO | 20,8 |
| NP | EUA721NPNWO | 20,8 |
| OO | EUA721OONWO | 26,0 |

Industria



RECESSED BODY
CORPO INCASSO
PARTIE ENCASTRÉ
IUA003CCXN_1 9,4

PACKAGING

L: 530 mm
D: 145 mm
H: 90 mm

4,16 kg

VERTICAL | VERTICALE | VERTICAL

PLATE AND HANDLES TRIMKIT
KIT PIASTRA E MANIGLIE
KIT PLAQUE ET POIGNÉE

| | | |
|----|--------------|------|
| CC | EUA711CCNID1 | 17,3 |
| SS | EUA711SSNID1 | 21,6 |
| NP | EUA711NPNID1 | 20,8 |
| CF | EUA711CFNID1 | 26,0 |
| CS | EUA711CSNID1 | 27,7 |
| OO | EUA711OONID1 | 26,0 |
| II | EUA711IINID1 | 26,0 |
| IS | EUA711ISNID1 | 27,7 |
| RS | EUA711RSNID1 | 26,0 |
| SR | EUA711SRNID1 | 27,7 |
| OS | EUA711OSNID1 | 27,7 |
| ON | EUA711ONNID1 | 17,3 |

HORIZONTAL | ORIZZONTALE | HORIZONTAL

PLATE AND HANDLES TRIMKIT
KIT PIASTRA E MANIGLIE
KIT PLAQUE ET POIGNÉE

| | | |
|----|--------------|------|
| CC | EUA721CCNID1 | 17,3 |
| SS | EUA721SSNID1 | 21,6 |
| NP | EUA721NPNID1 | 20,8 |
| CF | EUA721CFNID1 | 26,0 |
| CS | EUA721CSNID1 | 27,7 |
| OO | EUA721OONID1 | 26,0 |
| II | EUA721IINID1 | 26,0 |
| IS | EUA721ISNID1 | 27,7 |
| RS | EUA721RSNID1 | 26,0 |
| SR | EUA721SRNID1 | 27,7 |
| OS | EUA721OSNID1 | 27,7 |
| ON | EUA721ONNID1 | 17,3 |

Marmo



RECESSED BODY
CORPO INCASSO
PARTIE ENCASTRÉ
IUA003CCXN_1 9,4

PACKAGING

L: 530 mm
D: 145 mm
H: 90 mm

4,24 kg

MARBLE

White Carrara

Black Marquina

VERTICAL | VERTICALE | VERTICAL

PLATE AND HANDLES TRIMKIT
KIT PIASTRA E MANIGLIE
KIT PLAQUE ET POIGNÉE

| | | | |
|----|--------------|--------------|------|
| CC | EUA711CCNMR1 | EUA711CCNMR2 | 20,7 |
| SS | EUA711SSNMR1 | EUA711SSNMR2 | 25,9 |
| BO | EUA711BONMR1 | EUA711BONMR2 | 24,9 |
| NP | EUA711NPNMR1 | EUA711NPNMR2 | 24,9 |
| CF | EUA711CFNMR1 | EUA711CFNMR2 | 31,1 |
| CS | EUA711CSNMR1 | EUA711CSNMR2 | 33,2 |
| OO | EUA711OONMR1 | EUA711OONMR2 | 31,1 |
| II | EUA711IINMR1 | EUA711IINMR2 | 31,1 |
| IS | EUA711ISNMR1 | EUA711ISNMR2 | 33,2 |
| RS | EUA711RSNMR1 | EUA711RSNMR2 | 31,1 |
| SR | EUA711SRNMR1 | EUA711SRNMR2 | 33,2 |
| OS | EUA711OSNMR1 | EUA711OSNMR2 | 33,2 |
| ON | EUA711ONNMR1 | EUA711PLNMR2 | 20,7 |
| PL | EUA711PLNMR1 | EUA711PLNMR2 | 33,2 |

HORIZONTAL | ORIZZONTALE | HORIZONTAL

PLATE AND HANDLES TRIMKIT
KIT PIASTRA E MANIGLIE
KIT PLAQUE ET POIGNÉE

| | | | |
|----|--------------|--------------|------|
| CC | EUA721CCNMR1 | EUA721CCNMR2 | 20,7 |
| SS | EUA721SSNMR1 | EUA721SSNMR2 | 25,9 |
| BO | EUA721BONMR1 | EUA721BONMR2 | 24,9 |
| NP | EUA721NPNMR1 | EUA721NPNMR2 | 24,9 |
| CF | EUA721CFNMR1 | EUA721CFNMR2 | 31,1 |
| CS | EUA721CSNMR1 | EUA721CSNMR2 | 33,2 |
| OO | EUA721OONMR1 | EUA721OONMR2 | 31,1 |
| II | EUA721IINMR1 | EUA721IINMR2 | 31,1 |
| IS | EUA721ISNMR1 | EUA721ISNMR2 | 33,2 |
| RS | EUA721RSNMR1 | EUA721RSNMR2 | 31,1 |
| SR | EUA721SRNMR1 | EUA721SRNMR2 | 33,2 |
| OS | EUA721OSNMR1 | EUA721OSNMR2 | 33,2 |
| ON | EUA721ONNMR1 | EUA721PLNMR2 | 20,7 |
| PL | EUA721PLNMR1 | EUA721PLNMR2 | 33,2 |

Hermes



RECESSED BODY
CORPO INCASSO
PARTIE ENCASTRÉ
IUA003CCXN_1 9,4

PACKAGING

L: 530 mm
D: 145 mm
H: 90 mm

4,16 kg

VERTICAL | VERTICALE | VERTICAL

PLATE AND HANDLES TRIMKIT
KIT PIASTRA E MANIGLIE
KIT PLAQUE ET POIGNÉE

| | | |
|----|-------------|------|
| CC | EUA715CCNHR | 17,4 |
| SS | EUA715SSNHR | 21,8 |
| RS | EUA715RSNHR | 26,1 |
| OS | EUA715OSNHR | 27,9 |
| RR | EUA715RRNHR | 24,4 |
| BB | EUA715BBNHR | 24,4 |
| PL | EUA715PLNHR | 27,9 |

HORIZONTAL | ORIZZONTALE | HORIZONTAL

PLATE AND HANDLES TRIMKIT
KIT PIASTRA E MANIGLIE
KIT PLAQUE ET POIGNÉE

| | | |
|----|-------------|------|
| CC | EUA725CCNHR | 17,4 |
| SS | EUA725SSNHR | 21,8 |
| RS | EUA725RSNHR | 26,1 |
| OS | EUA725OSNHR | 27,9 |
| RR | EUA725RRNHR | 24,4 |
| BB | EUA725BBNHR | 24,4 |
| PL | EUA725PLNHR | 27,9 |

Birkin



RECESSED BODY
CORPO INCASSO
PARTIE ENCASTRÉ
IUA003CCXN_1 9,4

PACKAGING

L: 530 mm
D: 145 mm
H: 90 mm

4,16 kg

VERTICAL | VERTICALE | VERTICAL

PLATE AND HANDLES TRIMKIT
KIT PIASTRA E MANIGLIE
KIT PLAQUE ET POIGNÉE

| | | |
|----|--------------|------|
| CC | EUA715CCNBR3 | 22,3 |
| SS | EUA715SSNBR3 | 27,9 |
| RS | EUA715RSNBR3 | 33,5 |
| OS | EUA715OSNBR3 | 35,7 |
| PL | EUA715PLNBR3 | 35,7 |

HORIZONTAL | ORIZZONTALE | HORIZONTAL

PLATE AND HANDLES TRIMKIT
KIT PIASTRA E MANIGLIE
KIT PLAQUE ET POIGNÉE

| | | |
|----|--------------|------|
| CC | EUA725CCNBR3 | 22,3 |
| SS | EUA725SSNBR3 | 27,9 |
| RS | EUA725RSNBR3 | 33,5 |
| OS | EUA725OSNBR3 | 35,7 |
| PL | EUA725PLNBR3 | 35,7 |

Aqua



AQUARIVA
P. 580



AQUABEAT
P. 592



ONAIR 2.0
P. 606



DROP
P. 612



**MONAMOUR
SHOWER HEADS
+ ARMS**
P. 618

SHOWER

HEADS

SOFFIONI
TÊTE DE DOUCHE

Shower
head

AQUARIVA

Made to shine your wellness experience.

Peogettato per far risplendere la tua esperienza wellness.
Créée pour faire briller votre expérience de bien-être.

A shining surface, pure and linear geometric shapes: the AQUARIVA collection, through its minimal design, achieves an eternal creation whose aesthetic perfection will seduce your eye and mind. The components are manufactured in a high-quality raw material, finely worked in our laboratories. The three refined showerheads, available in twelve finishes and two sizes, provide a flexible but constant aesthetic elegance, in order to express freely your inimitable personality.

Una superficie lucente, forme geometriche pure e lineari: la collezione AQUARIVA perviene, tramite il suo design minimale, a una creazione eterna la cui perfezione estetica saprà affascinare occhio e mente. Le componenti sono realizzate a partire da una materia prima di alta qualità, finemente lavorata nei nostri laboratori. I tre ricercati soffioni doccia, disponibili in dodici finiture e in due dimensioni, garantiscono un'eleganza estetica duttile ma costante, per dare sfogo alla tua inimitabile personalità.

Une surface brillante, des formes géométriques pures et linéaires: la collection AQUARIVA parvient, par son design minimal, à une création éternelle dont la perfection esthétique saura fasciner les yeux et l'esprit. Les composants sont fabriqués à partir d'une matière première de haute qualité, finement travaillée dans nos laboratoires. Les trois sophistiqués pommes de douche, disponibles en douze finitions et en deux tailles, garantissent une élégance esthétique à la fois souple et constante, pour donner libre cours à votre inimitable personnalité.



LEAD FREE



ZINC FREE



RGB LIGHT





Aquariva

DESIGN
ANDREA + DAVIDE BREGOLI

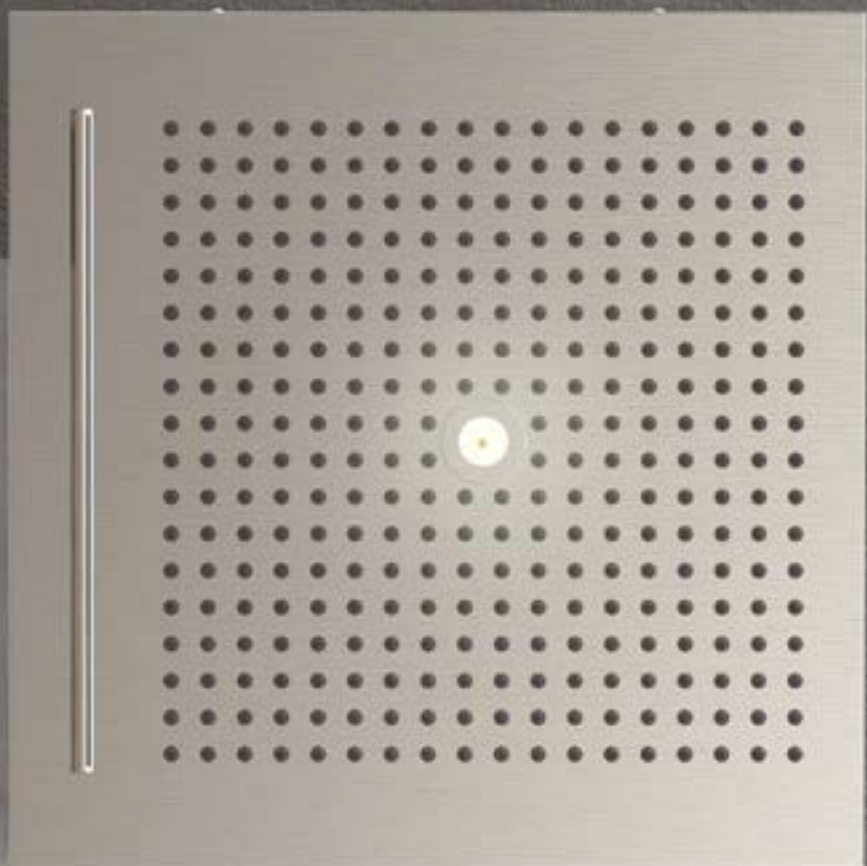

CC



CHROME
CHROMO
CHROME

SS



BRUSHED NICKEL
NICKEL SPAZZOLATO
NICKEL BROSSÉ

BO



MATT WHITE
BIANCO OPACO
BLANC MAT

NP



MATT BLACK
NERO OPACO
NOIR MAT

CF



BLACK CHROME
BLACK CHROME
CHROME NOIR

CS



BRUSHED BLACK CHROME
CROMO NERO SPAZZOLATO
CHROME NOIR BROSSÉ

OO

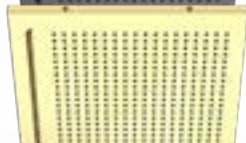

GOLD 22K
ORO 22K
OR 22K

OS



BRUSHED GOLD 22K
ORO SPAZZOLATO 22K
OR BROSSÉ 22K

II



PALE GOLD 18K
ORO INGLESE 18K
OR PALE 18K

IS



BRUSHED PALE GOLD 18K
ORO INGLESE SPAZZOLATO 18K
OR PALE BROSSÉ 18K

RS



ROSE GOLD 18K
ORO ROSA 18K
OR ROSE 18K

SR

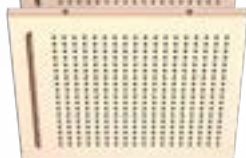

BRUSHED ROSE GOLD 18K
ORO ROSA SPAZZOLATO 18K
OR ROSE BROSSÉ 18K

Aquariva

AQUARIVA knows your every wish and will fulfil it through a range of four different functions, from the nebulized jet to chromotherapy, that merge and intersect to recreate the harmonic and relaxing atmosphere of an authentic home Spa completely at your service.

AQUARIVA conosce ogni tuo desiderio, e saprà realizzarlo attraverso una gamma di 4 funzioni differenti, dal getto nebulizzato alla cromoterapia, che convergono e si compenetrano per ricreare l'ambiente armonioso e rilassante di un'autentica Spa casalinga a tuo completo servizio.

AQUARIVA connaît tous vos désirs et va les réaliser à travers quatre fonctions différentes, allant du jet nébulisé à la chromothérapie, qui convergent et se mêlent pour recréer l'atmosphère harmonieuse et relaxante d'un authentique Spa à domicile, à votre entière disposition.

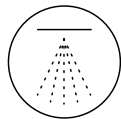

Nebulization

Nebulizzazione
Pulvérisation

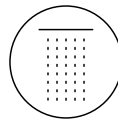

Rain jet

Getto a pioggia
Jet de pluie



Waterfall

Cascata
Chute d'eau

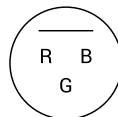

Chromo therapy

Cromoterapia
Chromothérapie





Chromotherapy: the colours of wellness

Cromoterapia: il benessere a colori

Chromothérapie: le bien-être en couleurs

GREEN_

It affects the nervous system, inducing harmony and calm, and helping to forge a pensive attitude.

Agisce sul sistema nervoso, inducendo all'armonia e alla calma, e contribuendo a forgiare un atteggiamento riflessivo.

Il agit sur le système nerveux, induisant à l'harmonie et à la calme et favorisant une attitude réflexive.

BLUE_

It acts on the nervous system, with calming and invigorating effects, against stress, anxiety and insomnia disorders.

Agisce sul sistema nervoso, con effetti calmanti e corroboranti, contro lo stress e i disturbi d'ansia e d'insonnia.

Il agit sur le système nerveux avec un effet apaisant et vivifiant, contre le stress, l'anxiété et les troubles de l'insomnie.

RED_

It stimulates adrenaline and fights melancholy by transmitting heat, strengthening vital energy and passion.

Stimola l'adrenalina e combatte la malinconia, trasmettendo calore, rafforzando l'energia vitale e la passione.

Il stimule l'adrénaline et combat la mélancolie en transmettant la chaleur, renforçant l'énergie vitale et la passion.

YELLOW_

It promotes concentration and good mood, thanks to its revitalizing effects inciting to movement and transformation.

Favorisce la concentrazione e il buonumore, grazie ai suoi effetti rivitalizzanti che incitano al movimento e alla trasformazione.

Il favorise la concentration et la bonne humeur, grâce à ses effets revitalisants qui incitent au mouvement et à la transformation.

Light control by remote control.

Controllo della luce tramite telecomando.

Contrôle de la lumière par télécommande.







ARTICLE | ARTICOLO | ARTICLE

AV360



Semi built-in showered with rain and waterfall.

Soffione doccia da semi incasso con getto a pioggia e cascata.

Pomme de douche semi-encastrée avec jet de pluie et chute d'eau.

| CODE / COEFFICIENT | CODICE / COEFFICIENTE | |
|--------------------|-----------------------|------|
| CC | AV360CC | 59,3 |
| SS | AV360SS | 79,3 |
| BO | AV360BO | 79,3 |
| NP | AV360NP | 79,3 |
| CF | AV360CF | 84,3 |
| CS | AV360CS | 84,3 |
| OO | AV360OO | 84,3 |
| OS | AV360OS | 84,3 |
| II | AV360II | 84,3 |
| IS | AV360IS | 84,3 |
| RS | AV360RS | 84,3 |
| SR | AV360SR | 84,3 |

PACKAGING

L: 455 mm
D: 455 mm
H: 155 mm

9 kg

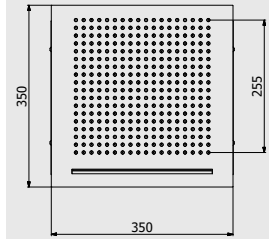

PORTATE | WATER FLOW | DÉBIT D'EAU

| | 1 BAR | 2 BAR | 3 BAR |
|---|----------|----------|----------|
| Head shower Soffione Tête de douche | 23,3 l/m | 33 l/m | 40,9 l/m |
| Waterfall Cascata Chute d'eau | 25,2 l/m | 36,2 l/m | 45 l/m |

ARTICLE | ARTICOLO | ARTICLE

AV370



Semi built-in showered with rain, waterfall and chromotherapy.

Soffione doccia da semi incasso con getto a pioggia, cascata e cromoterapia.

Pomme de douche semi-encastrée avec jet de pluie, chute d'eau et chromothérapie.

| CODE / COEFFICIENT | CODICE / COEFFICIENTE | |
|--------------------|-----------------------|-------|
| CC | AV370CC | 110,0 |
| SS | AV370SS | 130,0 |
| BO | AV370BO | 130,0 |
| NP | AV370NP | 130,0 |
| CF | AV370CF | 135,0 |
| CS | AV370CS | 135,0 |
| OO | AV370OO | 135,0 |
| OS | AV370OS | 135,0 |
| II | AV370II | 135,0 |
| IS | AV370IS | 135,0 |
| RS | AV370RS | 135,0 |
| SR | AV370SR | 135,0 |

PACKAGING

L: 455 mm
D: 455 mm
H: 155 mm

9 kg

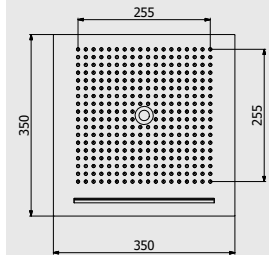

PORTATE | WATER FLOW | DÉBIT D'EAU

| | 1 BAR | 2 BAR | 3 BAR |
|---|----------|----------|----------|
| Head shower Soffione Tête de douche | 23,3 l/m | 33 l/m | 40,9 l/m |
| Waterfall Cascata Chute d'eau | 25,2 l/m | 36,2 l/m | 45 l/m |

ARTICLE | ARTICOLO | ARTICLE

AV630



Semi built-in showered with rain, waterfall, nebulization and chromotherapy.

Soffione doccia da semi incasso con getto a pioggia, cascata, nebulizzazione e cromoterapia.

Pomme de douche semi-encastrée avec jet de pluie, chute d'eau, vaporisation et chromothérapie.

| CODE / COEFFICIENT | CODICE / COEFFICIENTE | |
|--------------------|-----------------------|-------|
| CC | AV630CC | 240,0 |
| SS | AV630SS | 265,0 |
| BO | AV630BO | 265,0 |
| NP | AV630NP | 265,0 |
| CF | AV630CF | 275,0 |
| CS | AV630CS | 275,0 |
| OO | AV630OO | 275,0 |
| OS | AV630OS | 275,0 |
| II | AV630II | 275,0 |
| IS | AV630S | 275,0 |
| RS | AV630RS | 275,0 |
| SR | AV630SR | 275,0 |

PACKAGING

L: 705 mm
D: 705 mm
155: 98 mm

17 kg

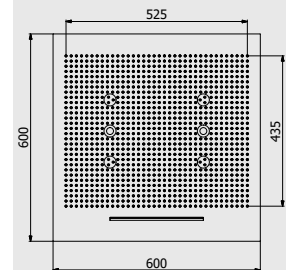

PORTATE | WATER FLOW | DÉBIT D'EAU

| | 1 BAR | 2 BAR | 3 BAR |
|--|----------|----------|----------|
| Head shower Soffione Tête de douche | 21,8 l/m | 32,8 l/m | 40,7 l/m |
| Waterfall Cascata Chute d'eau | 25,2 l/m | 36,2 l/m | 45 l/m |
| Nebulisation Nebulizzazione Nébulisation | 10,2 l/m | 15 l/m | 18 l/m |

Aquariva

Examples of possible combinations

Esempi di combinazioni possibili
Exemples de combinaisons possibles

ARTICLE | ARTICOLO | ARTICLE

AV360



COMBINATION | COMBINAZIONI | COMBINAISON



p. 510

Two ways wall shower mixer model 310.
Miscelatore doccia a parete con deviatore due vie modello 310.
Mitigeur douche mural deux voies avec inverseur référence 310.

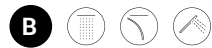

p. 511

Three ways wall shower mixer model 314.
Miscelatore doccia a parete con deviatore tre vie modello 314.
Mitigeur douche mural trois voies avec inverseur référence 314.

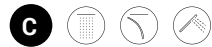

p. 577

AQUA thermostatic valve control 3 ways diverter.
AQUA valvola termostatica a 3 vie con deviatore.
AQUA valve thermostatique à 3 voies avec déviateur.

+



p. 654

Duplex round - round Model SH022.
Duplex Tondo - Tondo Modello SH022.
Duplex rond prise d'eau, douche rond Model SH022.

ARTICLE | ARTICOLO | ARTICLE

AV370



COMBINATION | COMBINAZIONI | COMBINAISON



p. 569

AQUA thermostatic valve control 2 ways diverter.
AQUA valvola termostatica a 2 vie con deviatore.
AQUA valve thermostatique à 2 voies avec déviateur.



p. 554

AQUA thermostatic valve control 2 independent ways.
AQUA valvola termostatica a 2 vie indipendenti.
AQUA valve thermostatique à 2 voies indépendante.

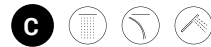

p. 550

AQUA thermostatic valve control 3 independent ways.
AQUA valvola termostatica a 3 vie indipendenti.
AQUA valve thermostatique à 3 voies indépendante.

+



p. 654

Duplex round - round Model SH022
Duplex Tondo - Tondo Modello SH022
Duplex rond prise d'eau, douche rond Model SH022

ARTICLE | ARTICOLO | ARTICLE

AV630



COMBINATION | COMBINAZIONI | COMBINAISON

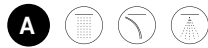

p. 510

One way wall shower mixer model 312.
Miscelatore doccia a parete una via modello 312.
Mitigeur douche mural une voie référence 312.



p. 556

AQUA thermostatic valve control 4 independent ways.
AQUA valvola termostatica a 4 vie indipendenti.
AQUA valve thermostatique à 4 voies indépendante.

+



p. 654

Duplex round - round Model SH022.
Duplex Tondo - Tondo Modello SH022.
Duplex rond prise d'eau, douche rond Model SH022.



p. 564

AQUA thermostatic valve control 5 independent ways.
AQUA valvola termostatica a 5 vie indipendenti.
AQUA valve thermostatique à 5 voies indépendante.

+



p. 654

Duplex round - round Model SH022.
Duplex Tondo - Tondo Modello SH022
Duplex rond prise d'eau, douche rond Model SH022.

+



p. 660

Round body - jet Model SH031.
Getto laterale tondo Modello SH031.
Body-Jet rond référence SH031.

Aquariva

AQUABEAT

Many functions, only one goal, your relax.

Tante funzioni, un obiettivo, il tuo relax.

De nombreuses fonction, un seul but, votre relaxation.

AQUABEAT collection aims to recreate the same well being and relaxing feelings of a professional Spa, through a wide selection of products adaptable to every desire. Choosing from a range of four showerheads, different in size and function, Aquabeat guarantees a wide set of services combinations, from chromotherapy and nebulization to the double waterfall and the cervical massage, cuddling you with a high quality personalized product.

La collezione AQUABEAT si propone di ricreare le stesse sensazioni di benessere e relax di una Spa professionale, attraverso un vasto assortimento di prodotti adattabili a ogni desiderio. Scegliendo tra una gamma di quattro soffioni doccia, variabili per dimensioni e funzioni, Aquabeat permetterà di variare la combinazione dei servizi, scegliendo tra cromoterapia, nebulizzazione, doppia cascata e massaggio cervicale, per una coccola personalizzata di alta qualità.

La collection AQUABEAT vise à recréer les mêmes sensations de bien-être et de détente d'un Spa professionnel, grâce à un grand assortiment de produits adaptables à tous les goûts. En choisissant parmi une gamme de quatre pommes de douche, variables par taille et fonction, Aquabeat vous permet de varier la combinaison de services, en triant la chromothérapie, la nébulisation, la double cascade ou le massage cervical, pour un câlin personnalisé de haute qualité.



LEAD FREE



ZINC FREE



RGB LIGHT



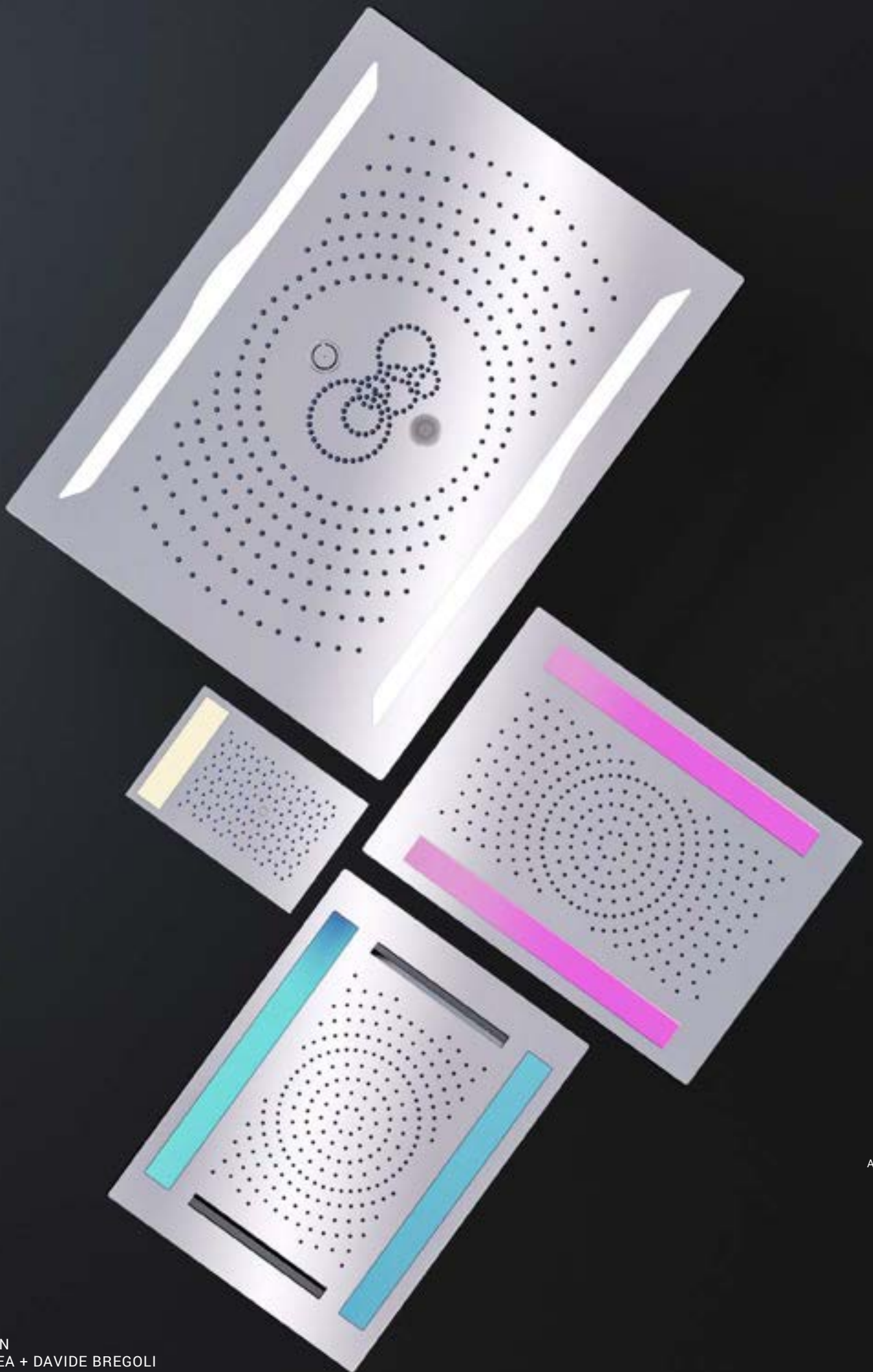

Aquabeat

DESIGN
ANDREA + DAVIDE BREGOLI

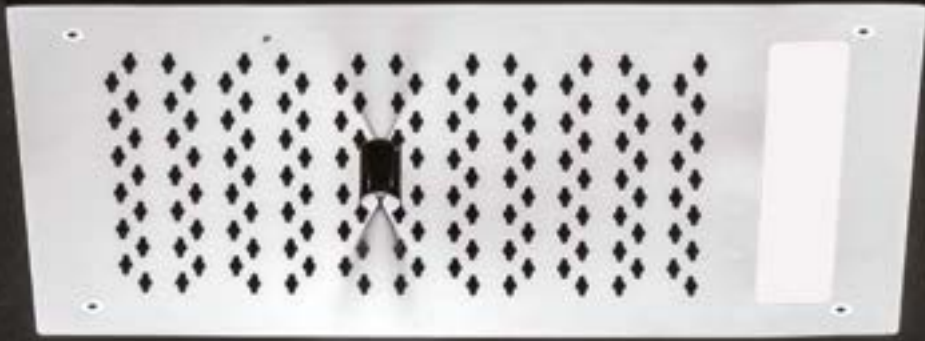



↑ AB200CC

→ AB400CC

← AB100CC



Aquabeat

AL_ Anti-limestone food safe silicone membrane

Membrana in silicone alimentare anti calcare.
Membrane en silicone alimentaire anticalcaire

RGB_ Chromotherapy thanks to integrated LED lighting

Illuminazione LED cromoterapeutica integrata
Éclairage LED chromothérapeutique intégré

56_{mm} Maximum depth required for fixing

Profondità massima necessaria per il fissaggio
Profondeur maximale de fixation requise

120_{mm} Up to 120 mm diagonal at the top of the showerhead range

Fino a 120 mm di estensione diagonale del soffione
Jusqu'à 120mm d'extension diagonale du pomme de douche

18_{L/m} For a minimum constant optimal operation

Funzionamento minimo costante ottimale
Profondeur maximale de fixation requise

1_{Bar} Minimum flow rate supported, even with flow rates of 1 Bar the water is fluent and doesn't lose its effectiveness.

Portata minima sopportata, anche con portate di 1 Bar l'acqua è fluente e non perde di efficacia.
Débit minimum toléré, même avec des débits de 1 bar, l'eau s'écoule et ne perd pas son efficacité.





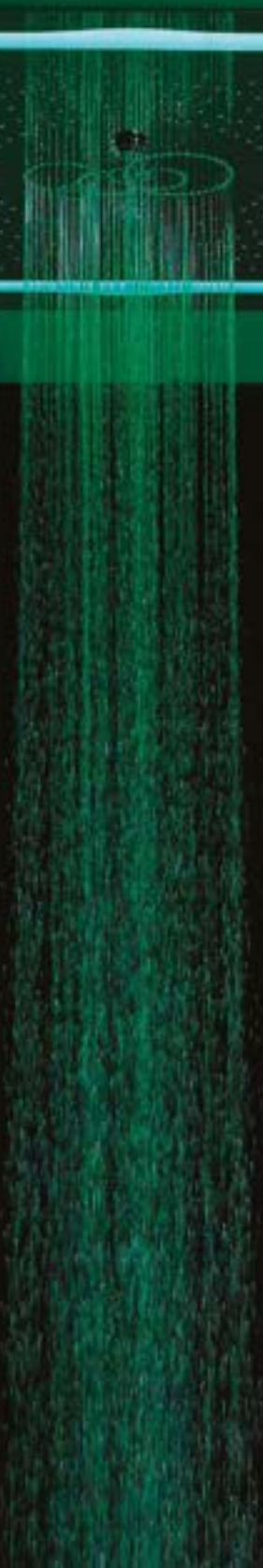

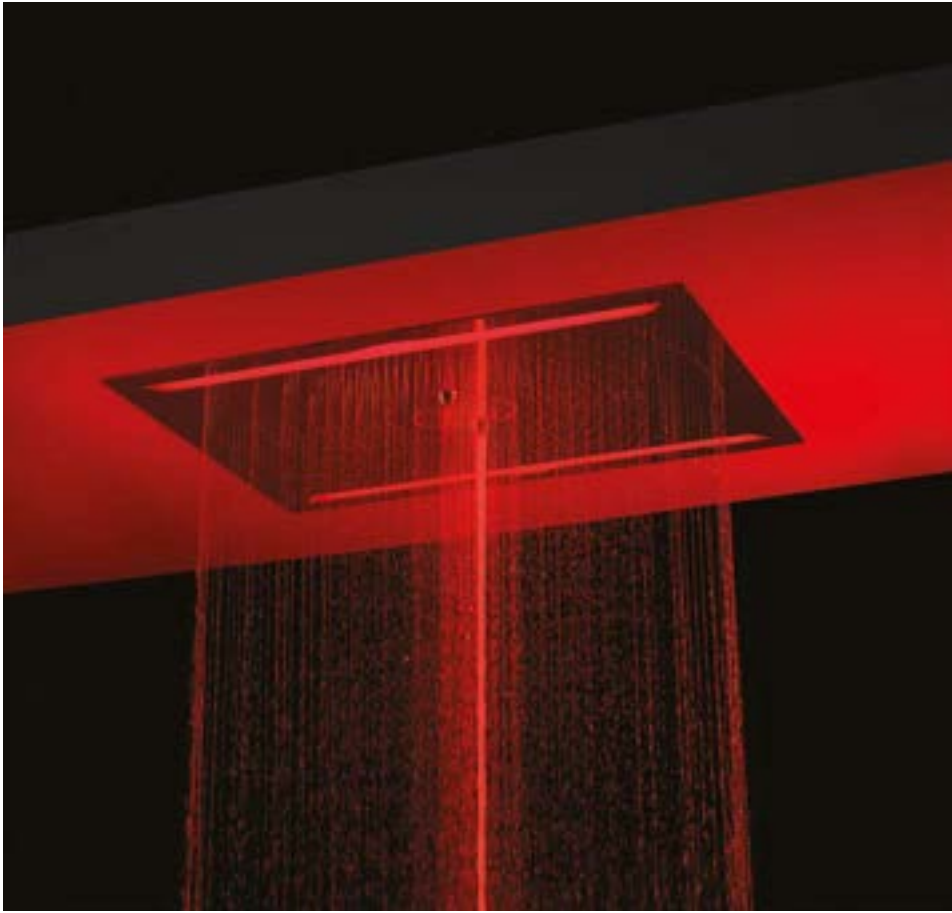

Aquabeat

Aquabeat offers some of the most requested functions for a complete support to your body and mind well-being. All the showerheads are equipped with integrated LED lights for chromotherapy with remote control and are associated with different water jets, from nebulization and double waterfall up to cervical massage.

Aquabeat offre una vasta gamma di funzioni tra le più richieste del settore, per un supporto completo al benessere del corpo e della mente. Tutti i soffioni sono forniti di luci LED integrate per la cromoterapia, gestibili in remoto e associate a getti d'acqua differenti, dalla nebulizzazione alla doppia cascata, fino al massaggio cervicale.

Aquabeat propose une large gamme de fonctions parmi les plus demandées du secteur, afin d'offrir un soutien complet au bien-être du corps et de l'esprit. Les pommes de douche sont tous équipés d'éclairage LED intégré pour la chromothérapie, gérable à distance et associé aux différents jets d'eau, allant du jet nébulisé et du massage cervical jusqu'à la double cascade.

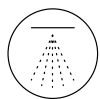

Nebulization

Nebulizzazione
Pulvérisation



Small rain

Soffione stretto
Tête de douche petite



Neck massage

Massaggio cervicale
Massage de la nuque



Rain jet

Getto a pioggia
Jet de pluie



Double waterfall

Cascata doppia
Chute d'eau double



Chromo therapy

Cromoterapia
Chromothérapie



Light control by remote control.
Controllo della luce tramite telecomando.
Contrôle de la lumière par télécommande.

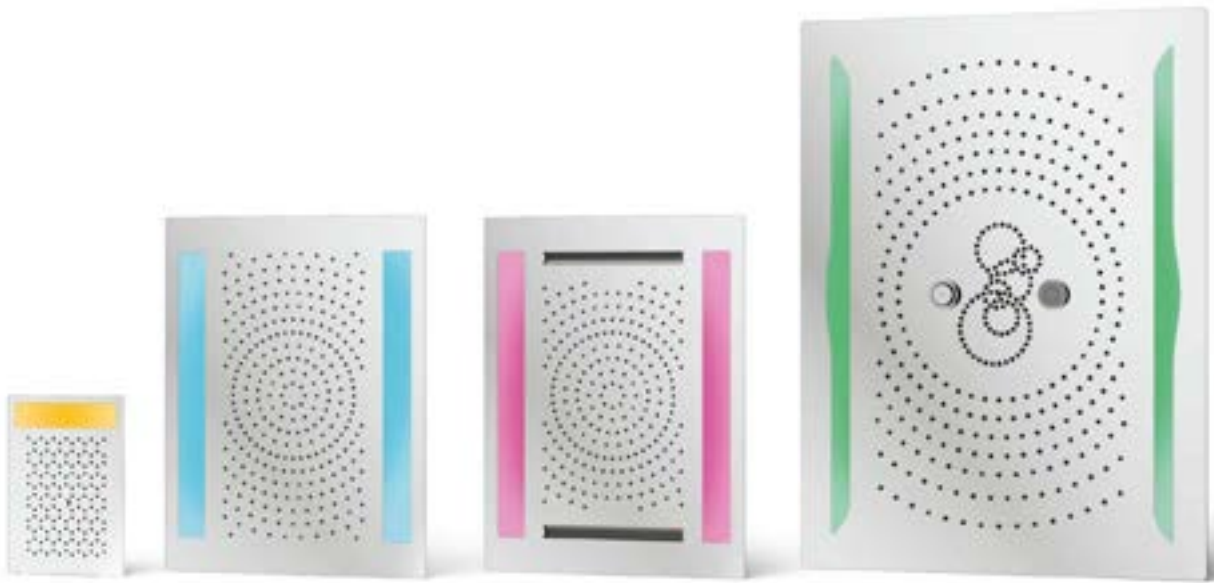

AQUABEAT SMALL

AB 100
300 x 200 x h45 mm



AQUABEAT MEDIUM

AB 200
600 x 450 x h56 mm



AQUABEAT MEDIUM +

AB 400
600 x 450 x h56 mm



AQUABEAT LARGE

AB 800
1000 x 700 x h56 mm



Aquabeat

ARTICLE | ARTICOLO | ARTICLE

AB100CC

Ceiling or wall mountable built in showerhead/body jet with rain, nebulization and chromotherapy.

Soffione doccia a incasso installabile a soffitto o a parete con getto a pioggia, nebulizzazione e cromoterapia.

Pomme de douche encastré pouvant être installé à plafond ou à mur, avec jet de pluie, nébulisation et chromothérapie

CODE / COEFFICIENT | CODICE / COEFFICIENTE | CODE / COEFFICIENT

CC AB100CC 27,5



DIMENSIONS | DIMENSIONI | DIMENSIONS

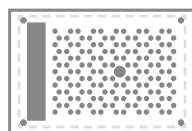

300 x 200 x h45

Shower head | Soffione | Douche

280 x 180 x h46

Size ceiling hole | Foro a soffitto | Dimension trou au plafond

PACKAGING

L: 455 mm D: 310 mm H: 75 mm 4,6 kg

FLOW RATE | PORTATE | DEBIT

3 BAR

Recessed mixer with diverter
model 310
Miscelatore incasso con
deviatore modello 310
Mélangeur encastré avec
déviateur référence 310

SHOWER
DOCCIA
DOUCHE

11 l/m

VAPORIZER
NEBULIZZATORE
PULVERISATION

0,60 l/m

ARTICLE | ARTICOLO | ARTICLE

AB200CC

Ceiling built-in showerhead with rain and chromotherapy.

Soffione doccia a incasso a soffitto con getto a pioggia e cromoterapia.

Pomme de douche encastré à plafond avec jet de pluie et chromothérapie.

CODE / COEFFICIENT | CODICE / COEFFICIENTE | CODE / COEFFICIENT

CC AB200CC 82,3



DIMENSIONS | DIMENSIONI | DIMENSIONS

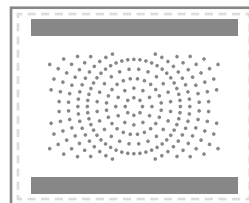

600 x 450 x h56

Shower head | Soffione | Douche

579 x 421 x h56

Size ceiling hole | Foro a soffitto | Dimension trou au plafond

PACKAGING

L: 800 mm D: 520 mm H: 135 mm 14,6 kg

FLOW RATE | PORTATE | DEBIT

3 BAR

Recessed mixer
with diverter
model 312
Miscelatore incasso
con deviatore
modello 312
Mélangeur en-
castré avec déviat-
eur référence 312

Recessed mixer
with three ways
model 312
Miscelatore
incasso 3 uscite
modello 312
Mélangeur enca-
stré trois voies
référence 312

MIXED WATER
ACQUA MISCELATA
EAU MÉLANGE

16,5 l/m

16,5 l/m



ARTICLE | ARTICOLO | ARTICLE

AB400CC

Ceiling built-in showerhead with rain, double waterfall and chromotherapy.

Soffione doccia a incasso a soffitto con getto a pioggia, doppia cascata e cromoterapia.

Pomme de douche encastré à plafond avec jet de pluie, double chute d'eau et chromothérapie.

CODE / COEFFICIENT | CODICE / COEFFICIENTE | CODE / COEFFICIENT

CC AB400CC 92,6



DIMENSIONS | DIMENSIONI | DIMENSIONS

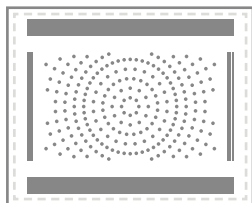

600 x 450 x h56

Shower head | Soffione | Douche

579 x 421 x h56

Size ceiling hole | Foro a soffitto | Dimension trou au plafond

PACKAGING

L: 800 mm D: 520 mm H: 135 mm 14,6 kg

| FLOW RATE PORTATE DEBIT | | | | |
|-----------------------------|---|--|--|----------|
| 3 BAR | Direct inlets Ingresso diretto Accès direct | Recessed mixer with diverter model 310 Miscelatore incasso con deviatore modello 310 Mélangeur encastré avec déviateur référence 310 | Recessed mixer with three ways model 312 Miscelatore incasso tre uscite modello 312 Mélangeur encastré trois voies référence 312 | |
| | SHOWERHEAD SOFFIONE TETE DE DOUCHE | 16,5 l/m | 16,5 l/m | 20,5 l/m |
| | WATERFALL CASCATA CHUTE D'EAU | 20,5 l/m | 20,5 l/m | 20,5 l/m |

ARTICLE | ARTICOLO | ARTICLE

AB800CC

Ceiling built-in showerhead with rain, lateral water veils, intense rain, aerated, nebulization and chromotherapy.

Soffione doccia a incasso a soffitto con getto a pioggia, veli d'acqua laterali, pioggia intensa, getto aerato, nebulizzazione e cromoterapia.

Pomme de douche encastré à plafond avec jet de pluie, voiles d'eau latérales, pluie intense, jet aéré, nébulisation et chromothérapie.

CODE / COEFFICIENT | CODICE / COEFFICIENTE | CODE / COEFFICIENT

CC AB800CC 139,6



DIMENSIONS | DIMENSIONI | DIMENSIONS

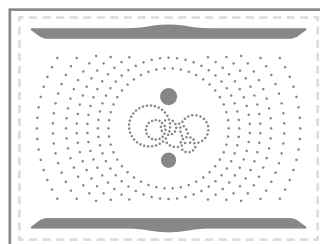

1000 x 700 x h56

Shower head | Soffione | Douche

969 x 673 x h56

Size ceiling hole | Foro a soffitto | Dimension trou au plafond

PACKAGING

L: 1140 mm D: 840 mm H: 150 mm 37,8 kg

| FLOW RATE PORTATE DEBIT | |
|--|---|
| 3 BAR | Direct inlets Ingresso diretto Accès direct |
| OUTSIDE RAIN CORONA ESTERNA CHUTE D'EAU EXTÉRIEURE | 15,5 l/m |
| TOTALE RAIN CORONA TOTALE CHUTE D'EAU TOTALE | 16,5 l/m |
| CENTRAL RAIN CORONA CENTRALE CHUTE D'EAU CENTRALE | 15 l/m |
| NEBULIZER NEBULIZZATORE VAPORISATEUR | 0,6 l/m |
| AERATOR MASSAGGIO CERVICALE MASSAGE AU COU | 10 l/m |

Aquabeat

Examples of possible combinations

Esempi di combinazioni possibili
Exemples de combinaisons possibles

ARTICLE | ARTICOLO | ARTICLE

AB100CC



COMBINATION | COMBINAZIONI | COMBINAISON



p. 510

Two ways wall shower mixer model 310
Miscelatore doccia a parete con deviatore due vie modello 310
Mitigeur douche mural 2 voies avec inverseur référence 310

ARTICLE | ARTICOLO | ARTICLE

AB200CC



COMBINATION | COMBINAZIONI | COMBINAISON



p. 510

One way wall shower mixer model 300
Miscelatore doccia a parete una via Modello 300
Mitigeur douche mural 1 voie référence 300

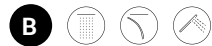

p. 510

Three ways wall shower mixer model 314
Miscelatore doccia a parete con deviatore tre vie modello 314
Mitigeur douche mural 3 voies avec inverseur référence 314

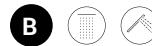

p. 510

Three ways wall shower mixer model 314
Miscelatore doccia a parete con deviatore tre vie modello 314
Mitigeur douche mural 3 voies avec inverseur référence 314



p. 577

+



p. 654

AQUA thermostatic valve control 3 ways diverter.
AQUA valvola termostatica a 3 vie con deviatore.
AQUA vanne thermostatique à 3 voies avec déviateur.

Duplex round - round Model SH022
Duplex Tondo - Tondo Modello SH022
Duplex rond prise d'eau, douche rond Model SH022



p. 550

+



p. 654

+



p. 227

AQUA thermostatic valve control 3 independent ways.
AQUA valvola termostatica a 3 vie indipendenti.
AQUA vanne thermostatique à 3 voies indépendantes.

Duplex round - round Model SH022
Duplex Tondo - Tondo Modello SH022
Duplex rond prise d'eau, douche rond Model SH022

Built-in wall mounted water-fall spout
Cascata a parete con erogazione esterna
Cascade murale avec bec externe



ARTICLE | ARTICOLO | ARTICLE

AB400CC



COMBINATION | COMBINAZIONI | COMBINAISON



p. 510

Three ways wall shower mixer model 314
Miscelatore doccia a parete con deviatore tre vie modello 314
Mitigeur douche mural 3 voies avec inverseur référence 314

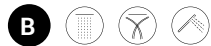

p. 550

AQUA thermostatic valve control 3 independent ways.
AQUA valvola termostatica a 3 vie indipendenti.
AQUA vanne thermostatique à 3 voies indépendantes.

+



p. 654

Duplex round - round Model SH022
Duplex Tondo - Tondo Modello SH022
Duplex rond prise d'eau, douche rond Model SH022



p. 556

AQUA thermostatic valve control 4 independent ways.
AQUA valvola termostatica a 4 vie indipendenti.
AQUA vanne thermostatique à 4 voies indépendantes.

+



p. 654

Duplex round - round Model SH022
Duplex Tondo - Tondo Modello SH022
Duplex rond prise d'eau, douche rond Model SH022

+



p. 660

Round body - jet Model SH031
Getto laterale tondo Modello SH031
Body-Jet rond référence SH031

ARTICLE | ARTICOLO | ARTICLE

AB800CC



COMBINATION | COMBINAZIONI | COMBINAISON



p. 556

Thermostatic valve 4 ways free
Valvola termostatica con 4 vie indipendenti
Valve thermostatique par 4 voies d'arrêt



p. 564

AQUA thermostatic valve control 5 independent ways.
AQUA valvola termostatica a 5 vie indipendenti.
AQUA vanne thermostatique à 5 voies indépendantes.

+



p. 654

Duplex round - round Model SH022
Duplex Tondo - Tondo Modello SH022
Duplex rond prise d'eau, douche rond Model SH022



p. 564

AQUA thermostatic valve control 5 independent ways.
AQUA valvola termostatica a 5 vie indipendenti.
AQUA vanne thermostatique à 5 voies indépendantes.

+



p. 227

Built-in wall mounted waterfall spout
Cascata a parete con erogazione esterna
Cascade murale avec bec externe

Aquabeat

ONAIR 2.0

Not an evolution but a different point of view, more subtle.

Non un'evoluzione ma un punto di vista diverso, più sottile.
Pas une evolution mais un point de vue different, plus subtil.

A steel blade stretching out from the wall like an arm, from which a powerful waterfall or the delicate touch of a thin drizzle flow: the ONAIR 2.0 collection offers a multiple jet shower fit to every desire and an innovative design, aesthetically delicate and elegant but technologically advanced, ready to update the traditional concept of shower.

Una lama in acciaio che si protende come un braccio dalla parete, da cui scende una cascata dalla prorompente purezza o il tocco delicato di una pioggerella fine: la collezione ONAIR 2.0 offre un prodotto dal getto differenziato capace di soddisfare ogni desiderio e un design innovativo, esteticamente delicato ed elegante ma tecnologicamente all'avanguardia, pronto ad aggiornare e riformulare il tradizionale concetto di doccia.

Une lame en acier qui se penche par le mur comme un bras, d'où tombe une cascade impétueuse ou une fine bruine délicate: la collection ONAIR 2.0 propose un produit aux jets différenciés capable de satisfaire tous les désirs avec un design innovant, esthétiquement délicat et élégant mais technologiquement avancée, prêt à renouveler et subvertir le concept traditionnel de douche.



LEAD FREE



ZINC FREE







The Airmix wall-mounted showerhead allows water and air to mix, guaranteeing the choice between two easily adjustable jets, the traditional rain showerhead and the hand shower with waterfall jet. The anti-limestone silicone nozzles also prevent any obstruction, providing a strong and constant flow.

Il soffione a parete Airmix permette di miscelare acqua e aria, garantendo la scelta tra due getti facilmente regolabili, il tradizionale soffione a pioggia direzionabile e il doccino comprensivo di getto a cascata. La presenza di ugelli in silicone anticalcare previene inoltre ogni ostruzione, garantendo un flusso forte e costante.

Le pomme de douche mural Airmix, grâce à sa capacité de mélanger eau et air, garantit le choix entre deux jets facilement réglables, le traditionnel pomme de douche au jet de pluie réglable et celui comprenant un jet à cascade. La présence de buses en silicone anticalcaire empêche en outre toute obstruction, garantissant un débit d'eau fort et constant.

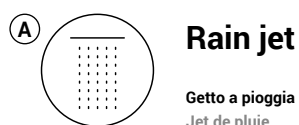





CODE / COEFFICIENT | CODICE / COEFFICIENTE | CODE / COEFFICIENT

CC OA101SS 18,0

PACKAGING

L: 685 mm D: 345 mm H: 168 mm 7,6 kg

FLOW RATE | PORTATA | DÉBIT D'EAU

| DIRECT INLETS INGRESSO DIRETTO ENTRÉE DIRECTE | | | |
|--|----------|----------|----------|
| | 1 BAR | 2 BAR | 3 BAR |
| Head shower Soffione Tête de douche | 15,3 l/m | 22,1 l/m | 26,1 l/m |
| Waterfall Cascata Chute d'eau | 14,8 l/m | 21 l/m | 24,3 l/m |
| RECESSED MIXER WITH DIVERTER MODEL 310 MISCELATORE INCASSO CON DEVIATORE 310 MELANGEUR ENCASTRÉ AVEC DÉVIATEUR RÉFÉRENCE 310 | | | |
| | 1 BAR | 2 BAR | 3 BAR |
| Head shower Soffione Tête de douche | 7,5 l/m | 10,6 l/m | 13 l/m |
| Waterfall Cascata Chute d'eau | 6,7 l/m | 9,6 l/m | 11,8 l/m |

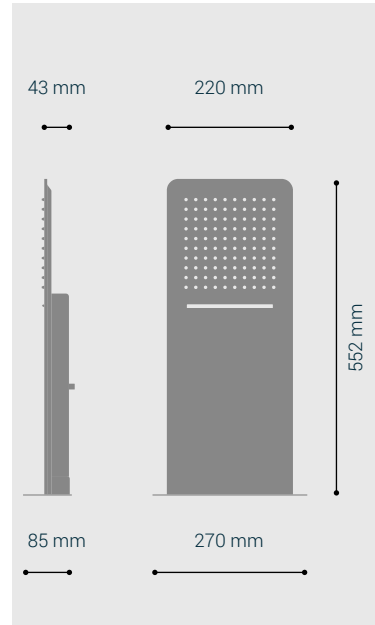

FITTING INSTRUCTIONS | ISTRUZIONI DI MONTAGGIO | INSTRUCTIONS DE MONTAGE

The two 1/2" water connections have to be in line with the wall and their interax have to be 40 mms. The water outlets will be on the left for the showerhead (A) and on the right for the waterfall (B).

Portare le due uscite dell'acqua con dei collegamenti da 1/2" a filo muro e con un interasse tra loro di 35 mm. Rispettivamente gli attacchi sono a sinistra per il soffione (A) e a destra per la cascata (B).

Amener les deux sorties de l'eau avec des connexions de 1/2 à fil du mur et avec une distance entre eux de 35 mm. Respectivement, les attaques sont à gauche pour la tête de douche (A) et à droite pour la chute d'eau (B).

Once the fixing plate is correctly installed on the wall, connect the showerhead to the water connections and installation into the plate.

Una volta fissata a muro la piastra di montaggio collegare il soffione all'impianto idraulico e a sua volta ancorarlo alla piastra.

Une fois fixé la plaque de montage à la paroi, relier la tête de douche à la tuyauterie et à son tour l'ancrer à la plaque.

Height from floor 2000 mm
Altezza consigliata da terra 2000 mm
Hauteur conseillée 2000 mm du sol

910 mm minimum shower base depth
Profondità minima piatto doccia 910 mm
Profondité minimal bac à douche 910 mm

DROP

A true icon of the bathroom.

Icona del design per il bagno.
Icône du design pour la salle de bain.

A true icon of the bathroom design, DROP replicates the features of a drop of water, deformable to touch, guaranteeing a gentle and regular flow. Designed by Giulio Iacchetti, this product has challenged the traditional shower design by innovating its form and material. Thanks to its aesthetic and technological features, DROP is the most suitable choice for an original and incomparable high-quality bathroom.

Icona del design per il bagno, la collezione DROP riproduce le fattezze di una goccia d'acqua deformabile al tatto e garantisce un flusso delicato e uniforme. Progettato da Giulio Iacchetti, questo prodotto ha rimesso in discussione la tradizione del design per docce, innovandone forma e materiale. Per le sue caratteristiche estetiche e tecnologiche, DROP è la scelta più adatta per un bagno d'autore dal carattere inedito e di alta qualità.

Icône du design pour la salle de bain, la collection DROP reproduit la silhouette d'une goutte d'eau, déformable au toucher, et garantit un débit délicat et uniforme. Conçu par Giulio Iacchetti, ce produit a remis en question le traditionnel design de la douche, en innovant sa forme et ses matériaux. En raison de ses caractéristiques esthétiques et technologiques, DROP est le choix le plus convenable pour une salle de bains d'auteur au caractère innovant de haute qualité.



LEAD FREE



ZINC FREE







The DROP showerhead is made of pure anti-limestone silicone and is available in six different colours, a technological and aesthetic innovation that earned it numerous awards and recognitions. DROP is also equipped with a valve that guarantees a water flow never exceeding 10.5 l / m.

Il soffione della collezione DROP è composto da puro silicone anticalcare ed è disponibile in sei colorazioni differenti, un'innovazione tecnologica ed estetica che gli è valsa numerosi premi e riconoscimenti. È inoltre dotato di una valvola di portata che garantisce un flusso d'acqua mai superiore a 10,5 l/m.

Le pomme de douche de la collection DROP est fabriqué en silicone anticalcaire et disponible en six couleurs différentes, une innovation technologique et esthétique qui lui a valu de nombreux prix et distinctions. Il est également doté d'une valve de débit garantissant un débit d'eau toujours inférieur aux 10,5 l / m.



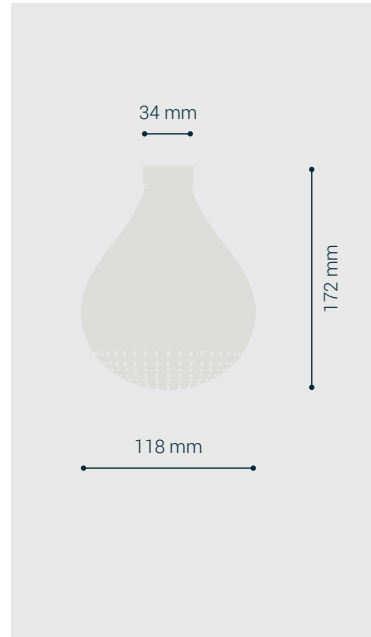
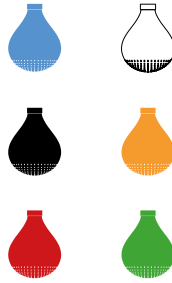

| COLOUR COLORE COLOR | CODE CODICE CODE | COEFFICIENT COEFFICIENTE COEFFICIENT |
|-------------------------|----------------------|--|
| ● Blue / Blu | DR001 | 3,1 |
| ○ White / Bianco | DR002 | 3,1 |
| ● Black / Nero | DR003 | 3,1 |
| ● Orange / Arancio | DR004 | 3,1 |
| ● Red / Rosso | DR005 | 3,1 |
| ● Green / Verde | DR006 | 3,1 |

PACKAGING

📦 L: 120 mm D: 120 mm H: 165 mm ⚖️ 0,4 kg

APPLICATIONS | APPLICAZIONI | APPLICATIONS

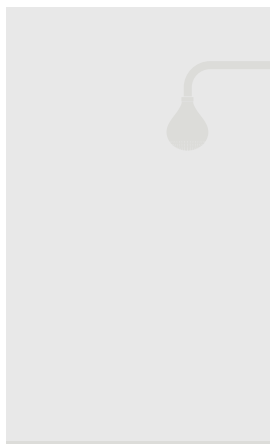

Wall mounted

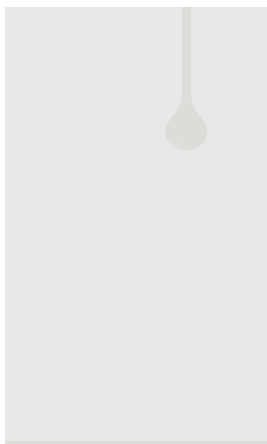

Ceiling mounted

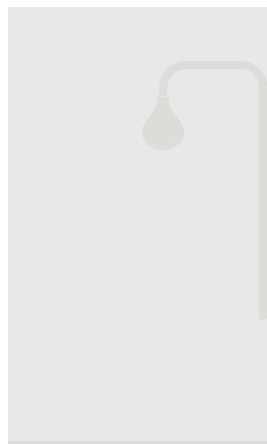

Shower column

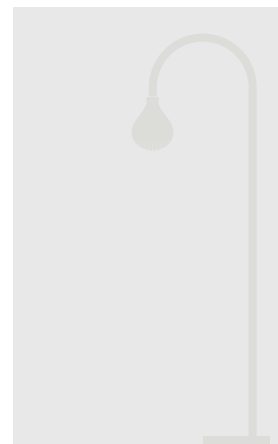

Free standing shower

Drop

MONAMOUR

Round and square rain over your head.

Pioggia rotonda e quadrata sopra la tua testa.
Une pluie ronde et carrée au-dessus de ta tête.

The Monamour showerheads collection represents the best solution for those who look for character and originality in their shower. Available in sixteen different finishes, Monamour offers a wide selection of showerheads, seven round and seven square, different in size and thickness, built-in or ceiling-mounted, thus offering a product adaptable to every individual taste and need and free from constraints.

La collezione soffioni Monamour rappresenta la migliore soluzione per chi ricerca personalità e originalità nella propria doccia. Disponibile in sedici finiture diverse, Monamour offre un'ampia scelta di soffioni, sette di forma rotonda e altrettanti di forma quadrata, diversi in dimensioni e spessore, incassati o a soffitto, garantendo così un prodotto adattabile a ogni singolo gusto ed esigenza e libero da costrizioni.

La collection de pommes de douche Monamour représente la meilleure solution pour ceux qui cherchent forte personnalité et originalité dans leur douche. Disponible en seize finitions différentes, Monamour offre un large choix de pommes de douche, sept de forme ronde et autant de forme carrée, de taille et d'épaisseur différentes, encastrés ou à plafond, garantissant un produit adaptable à chaque goût et besoin, et sans aucune contrainte.



LEAD FREE



ZINC FREE







↑ MA050RS
Round Showerhead Ø500 mm
Soffione tondo Ø500 mm
Tête de douche ronde Ø500 mm

→ MA033CC
Built-in stainless-steel round showerhead Ø332 mm
Soffione tondo Ø332 mm a incasso in acciaio inox
Tête de douche ronde encastré Ø332 mm en
acier inoxydable





ARTICLE | ARTICOLO | ARTICLE

MA012

Round Tradition Showerhead Ø200 mm

Soffione tondo Tradition Ø200 mm

Tête de douche ronde Tradition Ø200 mm

CODE / COEFFICIENT | CODICE /
COEFFICIENTE | CODE / COEFFICIENT

| | | |
|------|---------|-----|
| ● CC | MA012CC | 6,0 |
| ● PL | MA012PL | 9,6 |
| ● SS | MA012SS | 7,5 |
| ● II | MA012II | 9,0 |
| ● RS | MA012RS | 9,0 |
| ● OS | MA012OS | 9,6 |
| ● RR | MA012RR | 7,8 |
| ● BB | MA012BB | 7,8 |

PACKAGING

 L: 240 mm
D: 215 mm
H: 110 mm

1,2 kg

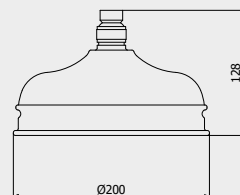

ARTICLE | ARTICOLO | ARTICLE

MA020

Round Showerhead Ø200 mm

Soffione tondo Ø200 mm

Tête de douche ronde Ø200 mm

CODE / COEFFICIENT | CODICE /
COEFFICIENTE | CODE / COEFFICIENT

| | | |
|------|---------|-----|
| ● CC | MA020CC | 3,8 |
| ● PL | MA020PL | 6,1 |
| ● SS | MA020SS | 4,8 |
| ● ON | MA020ON | 4,6 |
| ● BO | MA020BO | 4,6 |
| ● NP | MA020NP | 4,8 |
| ● CF | MA020CF | 5,7 |
| ● CS | MA020CS | 6,1 |
| ● II | MA020II | 5,7 |
| ● IS | MA020IS | 6,1 |
| ● RS | MA020RS | 5,7 |
| ● SR | MA020SR | 6,1 |
| ● OO | MA020OO | 5,7 |
| ● OS | MA020OS | 6,1 |
| ● RR | MA020RR | 5,3 |
| ● BB | MA020BB | 5,3 |

PACKAGING

 L: 210 mm
D: 210 mm
H: 70 mm

0,5 kg



ARTICLE | ARTICOLO | ARTICLE

MA025

Round Showerhead Ø250 mm

Soffione tondo Ø250 mm

Tête de douche ronde Ø250 mm

CODE / COEFFICIENT | CODICE /
COEFFICIENTE | CODE / COEFFICIENT

| | | |
|------|---------|-----|
| ● CC | MA025CC | 4,3 |
| ● PL | MA025PL | 6,9 |
| ● SS | MA025SS | 5,4 |
| ● ON | MA025ON | 5,2 |
| ● BO | MA025BO | 5,2 |
| ● NP | MA025NP | 5,4 |
| ● CF | MA025CF | 6,5 |
| ● CS | MA025CS | 6,9 |
| ● II | MA025II | 6,5 |
| ● IS | MA025IS | 6,9 |
| ● RS | MA025RS | 6,5 |
| ● SR | MA025SR | 6,9 |
| ● OO | MA025OO | 6,5 |
| ● OS | MA025OS | 6,9 |
| ● RR | MA025RR | 6,0 |
| ● BB | MA025BB | 6,0 |

PACKAGING

 L: 265 mm
D: 260 mm
H: 70 mm

1,4 kg

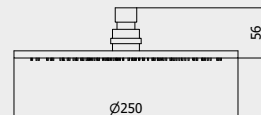

ARTICLE | ARTICOLO | ARTICLE

MA030

Round Showerhead Ø300 mm

Soffione tondo Ø300 mm

Tête de douche ronde Ø300 mm

CODE / COEFFICIENT | CODICE /
COEFFICIENTE | CODE / COEFFICIENT

| | | |
|------|---------|------|
| ● CC | MA030CC | 7,7 |
| ● PL | MA030PL | 12,3 |
| ● SS | MA030SS | 9,6 |
| ● ON | MA030ON | 9,2 |
| ● BO | MA030BO | 9,2 |
| ● NP | MA030NP | 9,6 |
| ● CF | MA030CF | 11,6 |
| ● CS | MA030CS | 12,3 |
| ● II | MA030II | 11,6 |
| ● IS | MA030IS | 12,3 |
| ● RS | MA030RS | 11,6 |
| ● SR | MA030SR | 12,3 |
| ● OO | MA030OO | 11,6 |
| ● OS | MA030OS | 12,3 |
| ● RR | MA030RR | 10,8 |
| ● BB | MA030BB | 10,8 |

PACKAGING

 L: 330 mm
D: 325 mm
H: 75 mm

3,2 kg



ARTICLE | ARTICOLO | ARTICLE

MA040



Round Showerhead Ø400 mm
Soffione tondo Ø400 mm
Tête de douche ronde Ø400 mm



| CODE / COEFFICIENT | CODICE / COEFFICIENTE | |
|--------------------|-----------------------|------|
| CC | MA040CC | 12,5 |
| PL | MA040PL | 20,0 |
| SS | MA040SS | 15,6 |
| BO | MA040BO | 15,0 |
| NP | MA040NP | 15,6 |
| CF | MA040CF | 18,8 |
| CS | MA040CS | 20,0 |
| II | MA040II | 18,8 |
| IS | MA040IS | 20,0 |
| RS | MA040RS | 18,8 |
| SR | MA040SR | 20,0 |
| OO | MA040OO | 18,8 |
| OS | MA040OS | 20,0 |
| RR | MA040RR | 17,5 |
| BB | MA040BB | 17,5 |

PACKAGING

L: 556 mm
D: 565 mm
H: 99 mm

3,3 kg

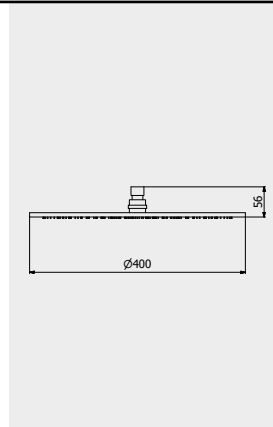

ARTICLE | ARTICOLO | ARTICLE

MA050



Round Showerhead Ø500 mm
Soffione tondo Ø500 mm
Tête de douche ronde Ø500 mm



| CODE / COEFFICIENT | CODICE / COEFFICIENTE | |
|--------------------|-----------------------|------|
| CC | MA050CC | 21,6 |
| PL | MA050PL | 34,6 |
| SS | MA050SS | 27,0 |
| BO | MA050BO | 25,9 |
| NP | MA050NP | 27,0 |
| CF | MA050CF | 32,4 |
| CS | MA050CS | 34,6 |
| II | MA050II | 32,4 |
| IS | MA050IS | 34,6 |
| RS | MA050RS | 32,4 |
| SR | MA050SR | 34,6 |
| OO | MA050OO | 32,4 |
| OS | MA050OS | 34,6 |
| RR | MA050RR | 30,2 |
| BB | MA050BB | 30,2 |

PACKAGING

L: 556 mm
D: 565 mm
H: 99 mm

7,6 kg

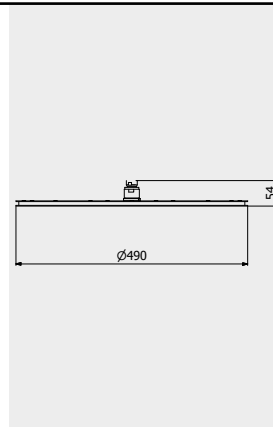

ARTICLE | ARTICOLO | ARTICLE

MA033



Built-in stainless-steel round showerhead Ø332 mm
Soffione tondo Ø332 mm a incasso in acciaio inox
Tête de douche ronde encastré Ø332 mm en acier inoxydable



| CODE / COEFFICIENT | CODICE / COEFFICIENTE | |
|--------------------|-----------------------|------|
| CC | MA033CC | 15,5 |

PACKAGING

L: 330 mm
D: 325 mm
H: 75 mm

2,9 kg

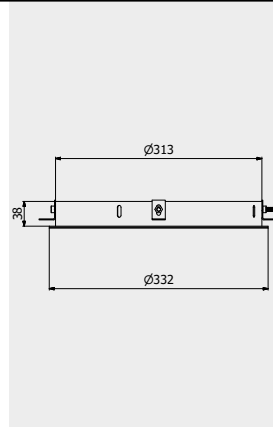

ARTICLE | ARTICOLO | ARTICLE

MA060



Shower arm with integrated shower aerator
Braccio doccia con areatore doccia integrato
Bras de douche avec aérateur de douche intégré



| CODE / COEFFICIENT | CODICE / COEFFICIENTE | |
|--------------------|-----------------------|-----|
| CC | MA060CC | 3,1 |
| PL | MA060PL | 5,0 |
| SS | MA060SS | 3,9 |
| ON | MA060ON | 3,1 |
| BO | MA060BO | 3,8 |
| NP | MA060NP | 3,8 |
| CF | MA060CF | 4,7 |
| CS | MA060CS | 5,0 |
| II | MA060II | 4,7 |
| IS | MA060IS | 5,0 |
| RS | MA060RS | 4,7 |
| SR | MA060SR | 5,0 |
| OO | MA060OO | 4,7 |
| OS | MA060OS | 5,0 |
| RR | MA060RR | 4,0 |
| BB | MA060BB | 4,0 |

PACKAGING

L: 150 mm
D: 190 mm
H: 98 mm

0,4 kg

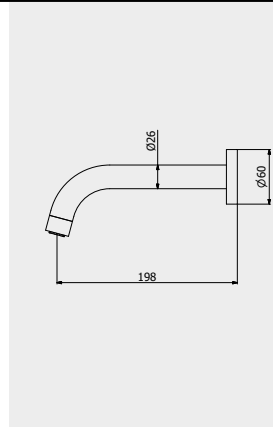

Monamour

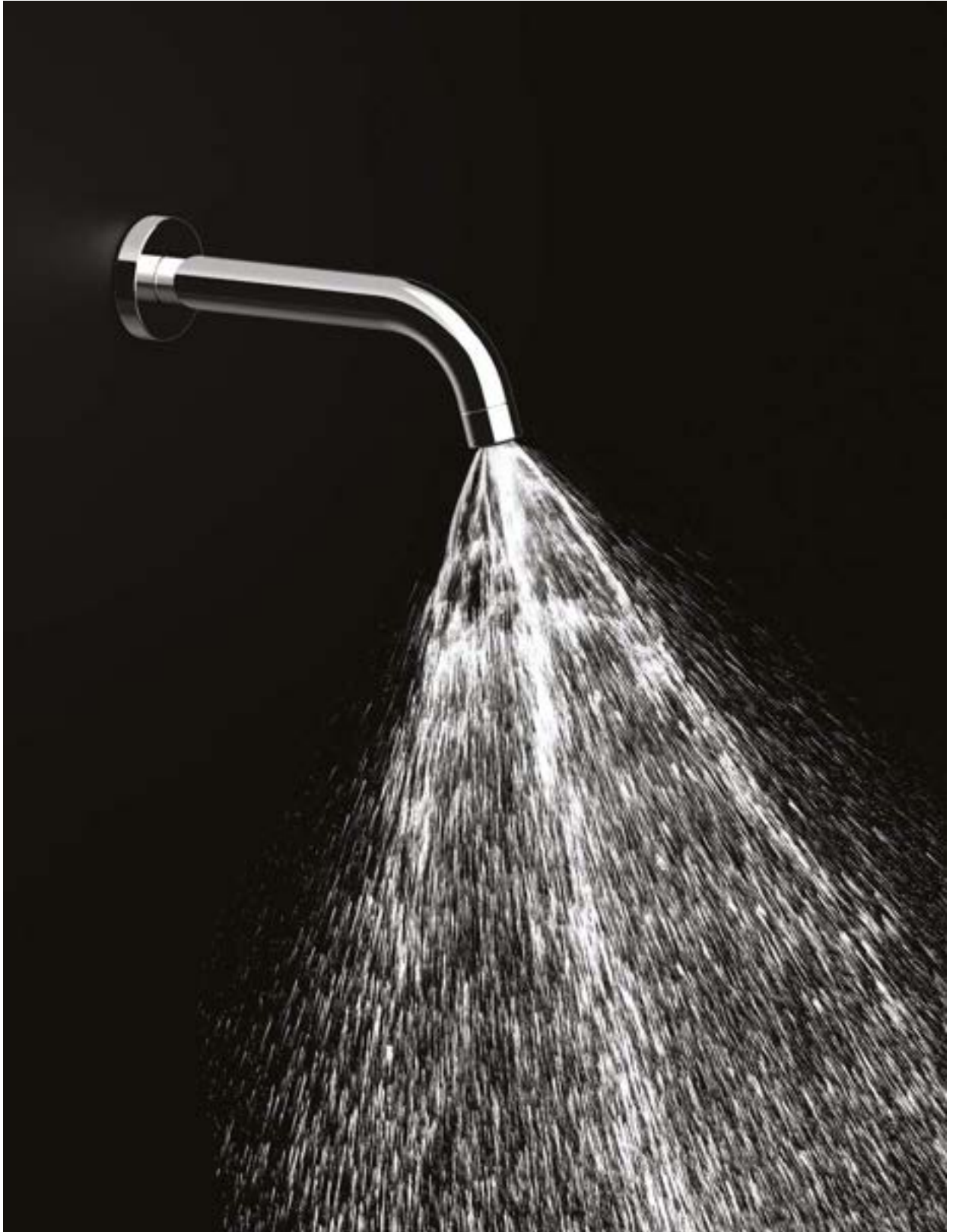

↑ MA060CC
Shower arm with integrated shower aerator
Braccio doccia con areatore doccia integrato
Bras de douche avec aérateur de douche intégré

→ MA051CC
Square Showerhead 500x500 mm
Soffione quadro 500x500 mm
Tête de douche carré 500x500 mm





ARTICLE | ARTICOLO | ARTICLE

MA021

Square Showerhead 200x200 mm
Soffione quadro 200x200 mm
Tête de douche carré 200x200 mm

CODE / COEFFICIENT | CODICE /
COEFFICIENTE | CODE / COEFFICIENT

| | | |
|------|---------|-----|
| ● CC | MA021CC | 4,2 |
| ● PL | MA021PL | 6,7 |
| ● SS | MA021SS | 5,3 |
| ● ON | MA021ON | 5,0 |
| ● BO | MA021BO | 5,0 |
| ● NP | MA021NP | 5,3 |
| ● CF | MA021CF | 6,3 |
| ● CS | MA021CS | 6,7 |
| ● II | MA021II | 6,3 |
| ● IS | MA021IS | 6,7 |
| ● RS | MA021RS | 6,3 |
| ● SR | MA021SR | 6,7 |
| ● OO | MA021OO | 6,3 |
| ● OS | MA021OS | 6,7 |
| ● RR | MA021RR | 5,9 |
| ● BB | MA021BB | 5,9 |

PACKAGING

L: 210 mm
D: 210 mm
H: 70 mm

1,5 kg

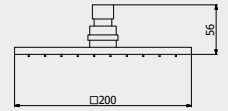

ARTICLE | ARTICOLO | ARTICLE

MA026

Square Showerhead 250x250 mm
Soffione quadro 250x250 mm
Tête de douche carré 250x250 mm

CODE / COEFFICIENT | CODICE /
COEFFICIENTE | CODE / COEFFICIENT

| | | |
|------|---------|-----|
| ● CC | MA026CC | 5,0 |
| ● PL | MA026PL | 8,0 |
| ● SS | MA026SS | 6,3 |
| ● ON | MA026ON | 6,0 |
| ● BO | MA026BO | 6,0 |
| ● NP | MA026NP | 6,3 |
| ● CF | MA026CF | 7,5 |
| ● CS | MA026CS | 8,0 |
| ● II | MA026II | 7,5 |
| ● IS | MA026IS | 8,0 |
| ● RS | MA026RS | 7,5 |
| ● SR | MA026SR | 8,0 |
| ● OO | MA026OO | 7,5 |
| ● OS | MA026OS | 8,0 |
| ● RR | MA026RR | 7,0 |
| ● BB | MA026BB | 7,0 |

PACKAGING

L: 265 mm
D: 260 mm
H: 70 mm

1,6 kg

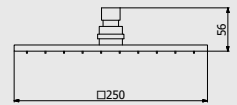

ARTICLE | ARTICOLO | ARTICLE

MA031

Square Showerhead 300x300 mm
Soffione quadro 300x300 mm
Tête de douche carré 300x300 mm

CODE / COEFFICIENT | CODICE /
COEFFICIENTE | CODE / COEFFICIENT

| | | |
|------|---------|------|
| ● CC | MA031CC | 9,0 |
| ● PL | MA031PL | 14,4 |
| ● SS | MA031SS | 11,3 |
| ● ON | MA031ON | 10,8 |
| ● BO | MA031BO | 10,8 |
| ● NP | MA031NP | 11,3 |
| ● CF | MA031CF | 13,5 |
| ● CS | MA031CS | 14,4 |
| ● II | MA031II | 13,5 |
| ● IS | MA031IS | 14,4 |
| ● RS | MA031RS | 13,5 |
| ● SR | MA031SR | 14,4 |
| ● OO | MA031OO | 13,5 |
| ● OS | MA031OS | 14,4 |
| ● RR | MA031RR | 12,6 |
| ● BB | MA031BB | 12,6 |

PACKAGING

L: 330 mm
D: 325 mm
H: 75 mm

3,7 kg

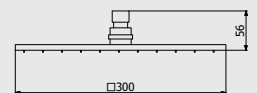

ARTICLE | ARTICOLO | ARTICLE

MA032

Square Showerhead 300x200 mm
Soffione quadro 300x200 mm
Tête de douche carré 300x200 mm

CODICE / COEFFICIENTE | CODE /
COEFFICIENT | CODE / COEFFICIENT

| | | |
|------|---------|-----|
| ● CC | MA032CC | 7,2 |
|------|---------|-----|

PACKAGING

L: 340 mm
D: 210 mm
H: 80 mm

1,9 kg

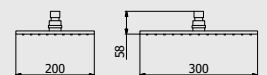

ARTICLE | ARTICOLO | ARTICLE

MA041



Square Showerhead 400x400 mm
Soffione quadro 400x400 mm
Tête de douche carré 400x400 mm



| CODE / COEFFICIENT | CODICE / COEFFICIENTE | |
|--------------------|-----------------------|------|
| CC | MA041CC | 14,0 |
| PL | MA041PL | 22,4 |
| SS | MA041SS | 17,5 |
| BO | MA041BO | 16,8 |
| NP | MA041NP | 17,5 |
| CF | MA041CF | 21,0 |
| CS | MA041CS | 22,4 |
| II | MA041II | 21,0 |
| IS | MA041IS | 22,4 |
| RS | MA041RS | 21,0 |
| SR | MA041SR | 22,4 |
| OO | MA041OO | 21,0 |
| OS | MA041OS | 22,4 |
| RR | MA041RR | 19,6 |
| BB | MA041BB | 19,6 |

PACKAGING

L: 556 mm
D: 565 mm
H: 99 mm

4,4 kg

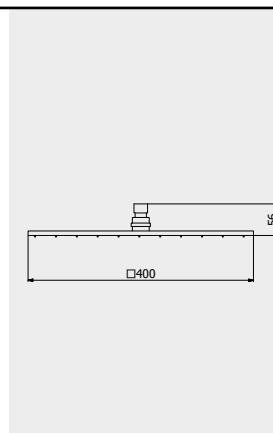

ARTICLE | ARTICOLO | ARTICLE

MA051



Square Showerhead 500x500 mm
Soffione quadro 500x500 mm
Tête de douche carré 500x500 mm

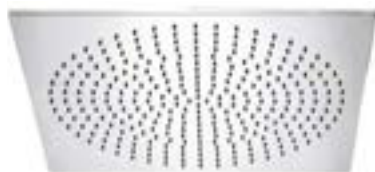

| CODE / COEFFICIENT | CODICE / COEFFICIENTE | |
|--------------------|-----------------------|------|
| CC | MA051CC | 22,1 |
| PL | MA051PL | 35,4 |
| SS | MA051SS | 27,6 |
| BO | MA051BO | 26,5 |
| NP | MA051NP | 27,6 |
| CF | MA051CF | 33,2 |
| CS | MA051CS | 35,4 |
| II | MA051II | 33,2 |
| IS | MA051IS | 35,4 |
| RS | MA051RS | 33,2 |
| SR | MA051SR | 35,4 |
| OO | MA051OO | 33,2 |
| OS | MA051OS | 35,4 |
| RR | MA051RR | 30,9 |
| BB | MA051BB | 30,9 |

PACKAGING

L: 556 mm
D: 565 mm
H: 99 mm

8,7 kg

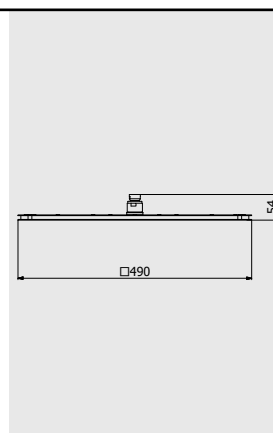

ARTICLE | ARTICOLO | ARTICLE

MA034



Built-in stainless-steel square showerhead 332x332 mm
Soffione quadro 332x332 mm a incasso in acciaio inox
Tête de douche carré encastré 332x332 mm en acier inoxydable



| CODE / COEFFICIENT | CODICE / COEFFICIENTE | |
|--------------------|-----------------------|------|
| CC | MA034CC | 17,1 |

PACKAGING

L: 330 mm
D: 325 mm
H: 75 mm

3,4 kg

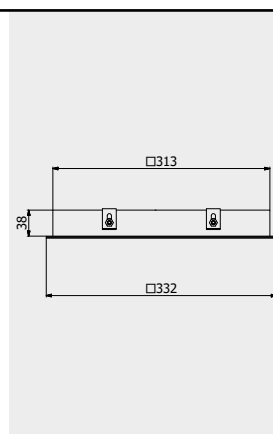

ARTICLE | ARTICOLO | ARTICLE

SH005



EASY arms and showerhead

Soffioncino con braccio EASY

Petite tête de douche avec bras EASY

| CODE / COEFFICIENT | CODICE / COEFFICIENTE | 1,4 |
|--------------------|-----------------------|-----|
| CC | SH005CC | 1,4 |

PACKAGING

| | |
|----|--------|
| L: | 175 mm |
| D: | 125 mm |
| H: | 90 mm |

| | |
|---------|--------|
| Weight: | 0,4 kg |
|---------|--------|

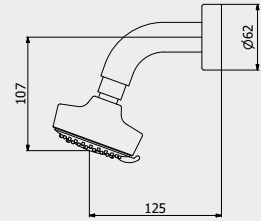

ARTICLE | ARTICOLO | ARTICLE

SH006



ABS round showerhead

Soffione tondo ABS

Tête de douche rond ABS

| CODE / COEFFICIENT | CODICE / COEFFICIENTE | 1,6 |
|--------------------|-----------------------|-----|
| CC | SH006CC | 1,6 |

PACKAGING

| | |
|----|--------|
| L: | 230 mm |
| D: | 210 mm |
| H: | 90 mm |

| | |
|---------|--------|
| Weight: | 1,0 kg |
|---------|--------|

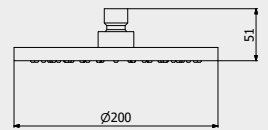

ARTICLE | ARTICOLO | ARTICLE

SH007



ABS square showerhead

Soffione quadro ABS

Tête de douche carré ABS

| CODE / COEFFICIENT | CODICE / COEFFICIENTE | 2,1 |
|--------------------|-----------------------|-----|
| CC | SH007CC | 2,1 |

PACKAGING

| | |
|----|--------|
| L: | 230 mm |
| D: | 210 mm |
| H: | 90 mm |

| | |
|---------|--------|
| Weight: | 1,0 kg |
|---------|--------|

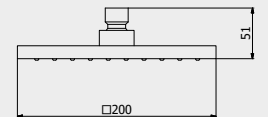

ARTICLE | ARTICOLO | ARTICLE

SH050



Round wall shower arm

Braccio doccia parete tondo

Bras de douche murale ronde

| | | |
|----|---------|-----|
| CC | SH050CC | 1,8 |
| SS | SH050SS | 2,3 |
| BO | SH050BO | 2,2 |
| NP | SH050NP | 2,3 |
| CF | SH050CF | 2,7 |
| CS | SH050CS | 2,9 |
| OO | SH050OO | 2,7 |
| II | SH050II | 2,7 |
| IS | SH050IS | 2,9 |
| RS | SH050RS | 2,7 |
| SR | SH050SR | 2,9 |
| OS | SH050OS | 2,9 |
| BB | SH050BB | 2,5 |
| RR | SH050RR | 2,5 |
| ON | SH050ON | 1,8 |
| PL | SH050PL | 2,9 |

PACKAGING

| | |
|----|--------|
| L: | 455 mm |
| D: | 107 mm |
| H: | 41 mm |

| | |
|---------|--------|
| Weight: | 0,7 kg |
|---------|--------|



ARTICLE | ARTICOLO | ARTICLE

SH052



Square wall shower arm
Braccio doccia parete quadro
Bras de douche murale carré

| | | |
|----|---------|-----|
| CC | SH052CC | 2,3 |
| SS | SH052SS | 2,9 |
| BO | SH052BO | 2,8 |
| NP | SH052NP | 2,9 |
| CF | SH052CF | 3,5 |
| CS | SH052CS | 3,7 |
| OO | SH052OO | 3,5 |
| II | SH052II | 3,5 |
| IS | SH052IS | 3,7 |
| RS | SH052RS | 3,5 |
| SR | SH052SR | 3,7 |
| OS | SH052OS | 3,7 |
| BB | SH052BB | 3,2 |
| RR | SH052RR | 3,2 |
| PL | SH052PL | 3,7 |

PACKAGING

L: 455 mm
D: 107 mm
H: 41 mm

0,7 kg



ARTICLE | ARTICOLO | ARTICLE

SH054



Round EXTRA-STRONG wall shower arm L 450 mm
Braccio doccia parete tondo RINFORZATO L 450 mm
Bras de douche au plafond ronde RENFORCÉ L 450 mm

| | | |
|----|---------|-----|
| CC | SH054CC | 5,2 |
| SS | SH054SS | 6,5 |
| BO | SH054BO | 6,2 |
| NP | SH054NP | 6,5 |
| CF | SH054CF | 7,8 |
| CS | SH054CS | 8,3 |
| OO | SH054OO | 7,8 |
| II | SH054II | 7,8 |
| IS | SH054IS | 8,3 |
| RS | SH054RS | 7,8 |
| SR | SH054SR | 8,3 |
| OS | SH054OS | 8,3 |
| BB | SH054BB | 7,3 |
| RR | SH054RR | 7,3 |
| PL | SH054PL | 8,3 |

PACKAGING

L: 540 mm
D: 130 mm
H: 70 mm

1,3 kg



ARTICLE | ARTICOLO | ARTICLE

SH053



Square ceiling shower arm
Braccio doccia soffitto quadro
Bras de douche au plafond carré

| | | |
|----|---------|-----|
| CC | SH053CC | 2,3 |
| SS | SH053SS | 2,9 |
| BO | SH053BO | 2,8 |
| NP | SH053NP | 2,9 |
| CF | SH053CF | 3,5 |
| CS | SH053CS | 3,7 |
| OO | SH053OO | 3,5 |
| II | SH053II | 3,5 |
| IS | SH053IS | 3,7 |
| RS | SH053RS | 3,5 |
| SR | SH053SR | 3,7 |
| OS | SH053OS | 3,7 |
| BB | SH053BB | 3,2 |
| RR | SH053RR | 3,2 |
| ON | SH053ON | 2,3 |
| PL | SH053PL | 3,7 |

PACKAGING

L: 455 mm
D: 107 mm
H: 41 mm

0,7 kg



ARTICLE | ARTICOLO | ARTICLE

SH051



Round ceiling shower arm
Braccio doccia soffitto tondo
Bras de douche au plafond ronde

| | | |
|----|---------|-----|
| CC | SH051CC | 2,3 |
| SS | SH051SS | 2,9 |
| BO | SH051BO | 2,8 |
| NP | SH051NP | 2,9 |
| CF | SH051CF | 3,5 |
| CS | SH051CS | 3,7 |
| OO | SH051OO | 3,5 |
| II | SH051II | 3,5 |
| IS | SH051IS | 3,7 |
| RS | SH051RS | 3,5 |
| SR | SH051SR | 3,7 |
| OS | SH051OS | 3,7 |
| BB | SH051BB | 3,2 |
| RR | SH051RR | 3,2 |
| ON | SH051ON | 2,3 |
| PL | SH051PL | 3,7 |

PACKAGING

L: 455 mm
D: 107 mm
H: 41 mm

0,7 kg



Monamour



WALLPAPER
P. 632



MONAMOUR
P. 638



OTHER
P. 642

SHOWER

COLUMNS

COLONNE DOCCIA
COLONNE DE DOUCHE

WALLPAPER

The luxury understatement by iB Rubinetti.

L'understatement secondo iB Rubinetti.

L'understatement de luxe selon iB Rubinetti.

Multi-functional shower in pure steel, WALLPAPER is the hidden gem in the IB Rubinetti collections. The shower is composed by an entirely built-in column, a wall level steel panel and controls that can monitor the use and intensity of three jets, employable independently or simultaneously thanks to the multifunctional control and completed by an efficient and accurate thermostatic regulator to set the required temperature.

Doccia multifunzionale in puro acciaio, WALLPAPER è la perla nascosta delle collezioni IB Rubinetti. Con una colonna completamente incassata e un pannello in acciaio perfettamente a raso parete, la doccia dispone di comandi per regolare l'utilizzo e l'intensità di tre getti, adoperabili autonomamente o in contemporanea grazie al comando multifunzione e integrati da un regolatore termostatico efficiente e ricettivo per impostare la temperatura desiderata.

Douche multifonctionnelle en pur acier, WALLPAPER est la merveille cachée des collections IB Rubinetti. Avec une colonne complètement encastrée et un panneau en acier parfaitement au ras du mur, la douche dispose de commandes pour la régulation de l'usage et de l'intensité de trois jets, utilisables indépendamment ou simultanément grâce au tableau de commande multifonctionnel et intégrés par un thermostat efficace et réceptif.



LEAD FREE



ZINC FREE







Equipped with four handles to regulate the showerhead and lateral jets, the intensity of the hand shower and the temperature, WALLPAPER also comes with directional bodyjets, easily manageable from the control panel.

Dotata di quattro manopole per regolare i getti a soffione e laterali, l'intensità del doccino e la temperatura dell'acqua, la doccia è inoltre costituita da bodyjet facilmente direzionabili e gestibili dal pannello di comando.

Dotée de quatre poignées réglant le pomme de douche et les jets latéraux, l'intensité de la douchette et la température de l'eau, la douche WALLPAPER est également composée de bodyjet réglables et gérables par le tableau de commande.

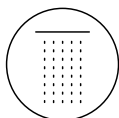

Showerhead

Doccia
Douche

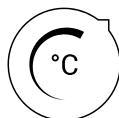

Thermostatic control

Comando termostatico
Régulation thermostatique

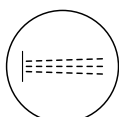

Adjustable bodyjet

Bodyjet direzionabili
Bodyjet directionnel

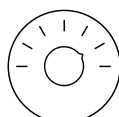

Free intensity adjustment

Regolazione intensità indipendente
Réglage indépendant de l'intensité



Handshower

Doccino
Douchette

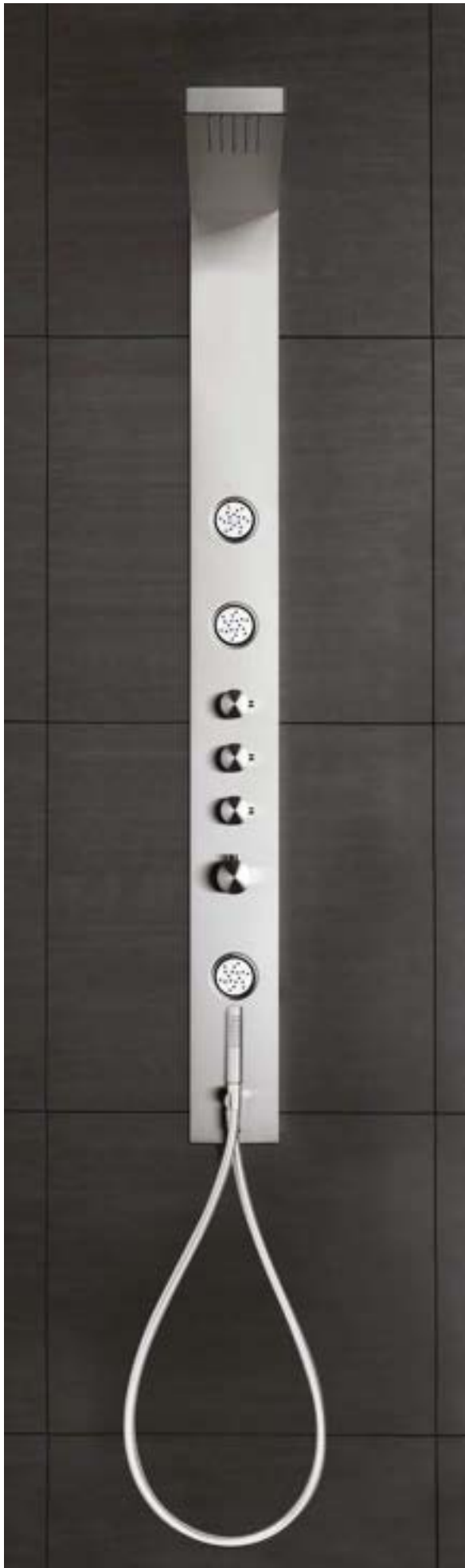



WATER FLOW | PORTATE | DÉBIT D'EAU

| | 1 BAR | 2 BAR | 3 BAR |
|---|--------|----------|---------|
| Head shower Soffione Tête de douche | 6 l/m | 7,8 l/m | 6,2 l/m |
| Shower Doccino Douchette | 9 l/m | 11,5 l/m | 9 l/m |
| Body Jet Body Jet Body Jet | 11 l/m | 14,2 l/m | 11 l/m |

PACKAGING

L: 1535 mm D: 220 mm H: 235 mm 17,5 kg

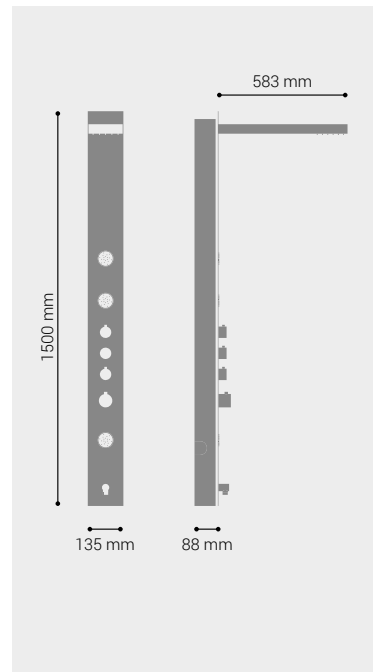

FITTING INSTRUCTIONS | ISTRUZIONI DI MONTAGGIO | INSTRUCTIONS DE MONTAGE

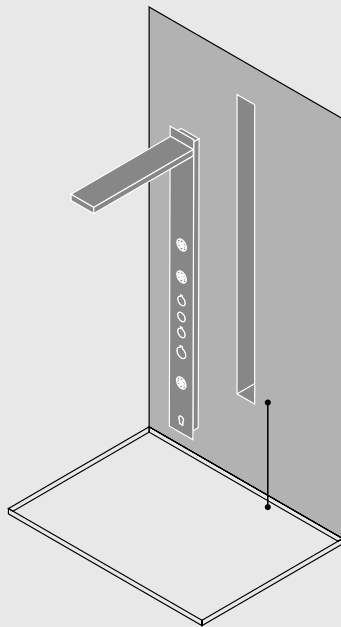

Concealed stainless steel installation box
Carter di Installazione in acciaio
Boîtier d'installation en acier

Distance from the floor 500mm
Distanza da terra 500 mm
Distance du sol 500mm

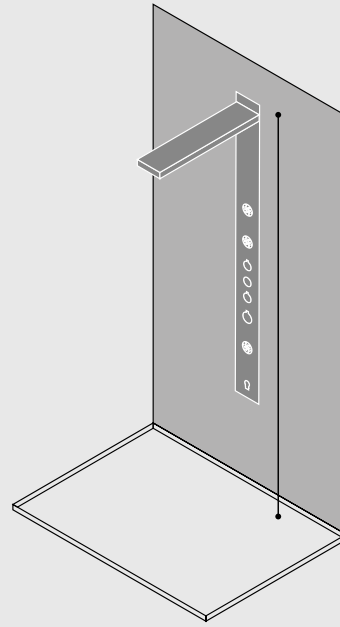

Distance between shower head to shower base 2000 mm
Distanza del soffione dal piatto doccia 2000 mm
Distance de la tête de douche du bac à douche 2000 mm

Wallpaper

MONAMOUR

The properties of a cuddle in the shower.

La qualità di una coccola in una doccia.
Les propriétés d'un câlin sous la douche.

MONAMOUR shower columns display the same high qualities of the showerheads collection: high functionality, easy to use, essential and sophisticated aesthetics. The efficiency of the thermostatic functions is combined with at the choice of quality materials . The shower is supplemented by two lateral jets and an easy-to-use and high-quality temperature and functions control system.

Le colonne doccia MONAMOUR rispecchiano tutte le alte qualità dei soffioni della collezione: alta funzionalità, facile utilizzo, estetica essenziale ed elegante. L'efficienza delle funzioni termostatiche combinata alla scelta di materiali di qualità. La doccia è completata dalla presenza di due getti laterali e da un sistema di comando della temperatura e delle funzioni di facile utilizzo e di alta qualità.

Les colonnes de douche MONAMOUR reflètent toutes les qualités des pommes de douche de la même collection: haute fonctionnalité, facilité d'utilisation, style essentiel et élégant. L'efficacité des fonctions thermostatiques est combinée au choix de matériaux de qualité. La douche est dotée de deux jets latéraux et d'un système de contrôle thermostatique très pratique et de haute qualité



LEAD FREE



ZINC FREE







In pure steel, MONAMOUR columns can be wall-mounted or built-in, according to the setting needs and the aesthetic preferences. They are all equipped with an efficient and functional thermostatic control, with an anti-limestone food safe silicone showerhead and a brass hand shower supplemented with a cromoloux hose.

In puro acciaio, le colonne MONAMOUR possono essere installate a parete o a incasso, secondo le necessità dell'ambiente e le preferenze estetiche. Sono tutte dotate di un comando termostatico efficiente e funzionale, di un soffione in silicone alimentare anticalcare e di un doccino in ottone integrato con flessibile Cromoloux.

Fabriquées en pur acier, les colonnes MONAMOUR peuvent être fixées au mur ou encastrées, selon les nécessités du milieu et les préférences esthétiques. Elles sont toutes dotées d'un contrôle thermostatique efficace et fonctionnel, d'un pomme de douche en silicone alimentaire anticalcaire et d'une douchette en laiton intégrée avec tuyau flexible Cromoloux.

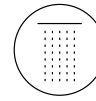

Showerhead

Doccia
Douche

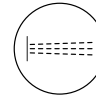

Bodyjet

Getti laterali
Bodyjet

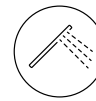

Hand shower

Doccino
Douchette

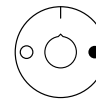

Function control

Controllo delle funzioni
Contrôle des fonctions

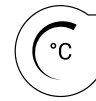

Thermostatic control

Comando termostatico
Régulation thermostatique

ARTICLE | ARTICOLO | ARTICLE

MA800



Polished steel free-standing shower column

Colonna doccia termostatica a parete

Colonne de douche thermostatique murale

CODE / COEFFICIENT | CODICE / COEFFICIENTE | CODE / COEFFICIENT

CC MA800CC 65,0

WATER FLOW | PORTATE | DÉBIT D'EAU

| | 1 BAR | 2 BAR | 3 BAR |
|---|----------|----------|----------|
| Soffione Head shower Tête de douche | 7,2 l/m | 6,5 l/m | 7,3 l/m |
| Doccino Shower Douchette | 10,4 l/m | 9,5 l/m | 10,5 l/m |
| Body Jet Body Jet Body Jet | 13 l/m | 11,6 l/m | 13 l/m |

PACKAGING

L: 1535 mm D: 220 mm H: 235 mm 17,5 kg

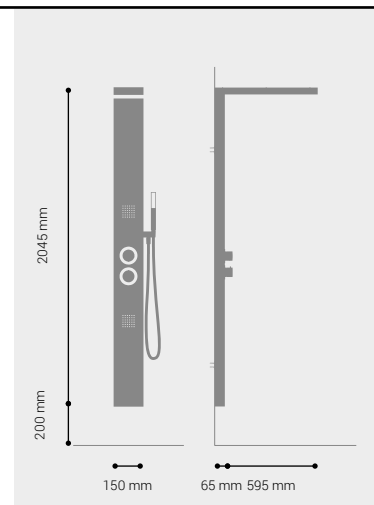

Monamour

SHOWER COLUMNS

In order to satisfy every taste and need, we have created a family of eight shower columns, perfect for any setting and innovative in their technology. The Shower Columns are all characterized by essential and refined geometric lines, round or square, and by a service suitable for every need, thanks to their thermostatic controls and first choice mixers. All columns are made of brass, available in twelve finishes and supplied with anti-limestone silicone membranes.

Per soddisfare ogni gusto ed esigenza, abbiamo creato una famiglia di otto colonne doccia, perfette per ogni ambiente e innovative nella loro tecnologia. Le colonne doccia sono tutte caratterizzate da linee geometriche essenziali e raffinate, rotonde o quadrate, e da un servizio adatto ad ogni esigenza, grazie ai comandi termostatici e ai miscelatori di prima scelta. Tutte le colonne sono realizzate in ottone, disponibili in dodici finiture e fornite con membrane siliconiche anticalcare.

Pour satisfaire tous les goûts et les besoins, nous avons créé une famille de huit colonnes de douche, idéales pour tout environnement et innovantes dans leur technologie. Les colonnes de douche se caractérisent par des lignes géométriques, rondes ou carrées, au design sobre et élégant et par un service fonctionnel à chaque besoin, grâce à ses commandes thermostatiques et ses mélangeurs de premier choix. Toutes les colonnes sont en laiton, disponibles en douze finitions et équipées de membranes en silicone anticalcaire.



LEAD FREE



ZINC FREE



OUTDOOR

THERMOSTATIC
VALVE



Shower
columns

ARTICLE | ARTICOLO | ARTICLE

MA125



Mixer shower column with round showerhead and hand shower
Colonna doccia con miscelatore, soffione tondo e doccia
Colonne de douche mitigeur avec tête de douche et douchette rondes

CODE / COEFFICIENT | CODICE /
COEFFICIENTE | CODE / COEFFICIENT

● CC MA125CC 20,9
● NP MA125NP 26,1

PACKAGING

📦 L: 1020 mm
D: 490 mm
H: 120 mm

📏 10,3 kg

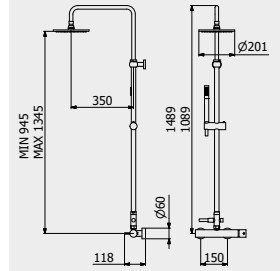

WATER FLOW | PORTATE | DÉBIT D'EAU

| 1 BAR | 2 BAR | 3 BAR |
|----------|----------|--------|
| 10,5 l/m | 15,5 l/m | 19 l/m |

ARTICLE | ARTICOLO | ARTICLE

MA126



Mixer shower column with square showerhead and hand shower
Colonna doccia con miscelatore, soffione quadrato e doccia
Colonne de douche mitigeur avec tête de douche et douchette carré

CODE / COEFFICIENT | CODICE /
COEFFICIENTE | CODE / COEFFICIENT

● CC MA126CC 26,3
● NP MA126NP 32,9

PACKAGING

📦 L: 1020 mm
D: 490 mm
H: 120 mm

📏 10,3 kg

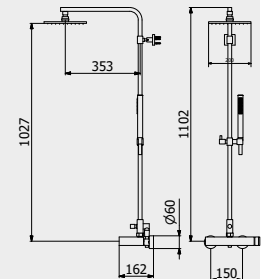

WATER FLOW | PORTATE | DÉBIT D'EAU

| 1 BAR | 2 BAR | 3 BAR |
|--------|--------|----------|
| 10 l/m | 15 l/m | 18,5 l/m |



ARTICLE | ARTICOLO | ARTICLE

MT127



Mixer shower column Whynot with round showerhead and hand shower
Colonna doccia Whynot con miscelatore, soffione tondo e docciaino
Colonne de douche Whynot mitigeur avec tête de douche et douchette rondes

| CODE / COEFFICIENT | CODICE / COEFFICIENTE | COEFFICIENT |
|--------------------|-----------------------|-------------|
| ☰ CC | MT127CC | 17,5 |
| ● NP | MT127NP | 20 |

PACKAGING
 L: 1500 mm
 D: 535 mm
 H: 120 mm
 10,3 kg

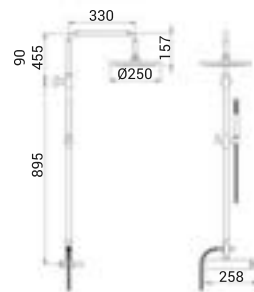

PORTATE | WATER FLOW | DÉBIT D'EAU

| 1 BAR | 2 BAR | 3 BAR |
|----------|----------|--------|
| 10,5 l/m | 15,5 l/m | 19 l/m |

ARTICLE | ARTICOLO | ARTICLE

B2800



Bold thermostatic shower column with shower kit
Colonna doccia Bold termostatica con kit doccia
Bold Colonne de douche thermostatique avec kit douche

| CODE / COEFFICIENT | CODICE / COEFFICIENTE | COEFFICIENT |
|--------------------|-----------------------|-------------|
| ☰ CC | B2800CC | 53,7 |
| ☳ SS | B2800SS | 67,1 |
| ● ON | B2800ON | 53,7 |
| ● NP | B2800NP | 64,4 |
| ● CF | B2800CF | 80,6 |
| ● CS | B2800CS | 85,9 |
| ● II | B2800II | 80,6 |
| ● IS | B2800IS | 85,9 |
| ● RS | B2800RS | 80,6 |
| ● SR | B2800SR | 85,9 |
| ● OO | B2800OO | 80,6 |
| ● OS | B2800OS | 85,9 |

PACKAGING
 L: 800 mm
 D: 500 mm
 H: 180 mm
 12,1 kg

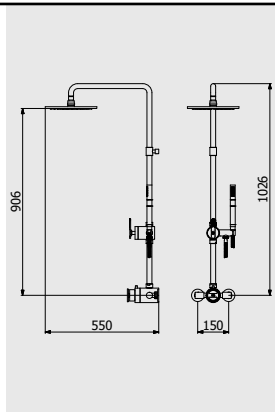

☑ _6 LEVA ROSSA | RED LEVER | LEVIER ROUGE + 0,2

PORTATE | WATER FLOW | DÉBIT D'EAU

| | 1 BAR | 2 BAR | 3 BAR |
|--|----------|---------|----------|
| Acqua miscelata / Mixed water / Eau mélangée | 10,7 l/m | 15 l/m | 18,5 l/m |
| Doccetta / Handshower / Douchette | 6,7 l/m | 9,6 l/m | 11,9 l/m |

Shower columns

ARTICLE | ARTICOLO | ARTICLE

ID800



Industria thermostatic shower column with shower kit

Colonna doccia Industria termostatica con kit doccia

Industria colonne de douche thermostatique avec kit douche

CODE / COEFFICIENT | CODICE / COEFFICIENTE | CODE / COEFFICIENT

BODY | CORPO | CORPS

LEVER | LEVA | LEVIER



+



| | | |
|------|---------|------|
| ● CC | ID800CC | 30,8 |
| ● SS | ID800SS | 46,1 |
| ● ON | ID800ON | 30,8 |
| ● NP | ID800NP | 36,9 |
| ● CF | ID800CF | 46,1 |
| ● CS | ID800CS | 49,2 |
| ● II | ID800II | 46,1 |
| ● IS | ID800IS | 49,2 |
| ● RS | ID800RS | 46,1 |
| ● SR | ID800SR | 49,2 |
| ● OO | ID800OO | 46,1 |
| ● OS | ID800OS | 49,2 |



| | | |
|------|-----|-----|
| ● CC | _1 | 5,4 |
| ● SS | _14 | 8,1 |
| ● ON | _10 | 5,4 |
| ● NP | _13 | 6,5 |
| ● CF | _3 | 8,1 |
| ● CS | _4 | 8,6 |
| ● II | _8 | 8,1 |
| ● IS | _9 | 8,6 |
| ● RS | _7 | 8,1 |
| ● SR | _14 | 8,6 |
| ● OO | _5 | 8,1 |
| ● OS | _9 | 8,6 |

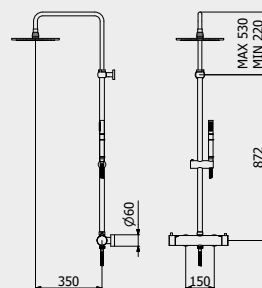

PORTATE | WATER FLOW | DÉBIT D'EAU

| | | |
|----------|--------|----------|
| 1 BAR | 2 BAR | 3 BAR |
| 11,3 l/m | 17 l/m | 21,2 l/m |

PACKAGING

L: 1020 mm
D: 490 mm
H: 120 mm

3,4 kg

ARTICLE | ARTICOLO | ARTICLE

MT801



Milano Torino thermostatic shower column with shower kit

Colonna doccia Milano Torino termostatica con kit doccia

Milano Torino colonne de douche thermostatique avec kit douche

CODE / COEFFICIENT | CODICE / COEFFICIENTE | CODE / COEFFICIENT

| | | |
|------|---------|------|
| ● CC | MT801CC | 34,4 |
| ● SS | MT801SS | 43,0 |
| ● BO | MT801BO | 41,3 |
| ● NP | MT801NP | 41,3 |
| ● CF | MT801CF | 51,7 |
| ● CS | MT801CS | 55,1 |
| ● II | MT801II | 51,7 |
| ● IS | MT801IS | 55,1 |
| ● RS | MT801RS | 51,7 |
| ● SR | MT801SR | 55,1 |
| ● OO | MT801OO | 51,7 |
| ● OS | MT801OS | 55,1 |

PACKAGING

L: 1020 mm
D: 490 mm
H: 120 mm

3,4 kg

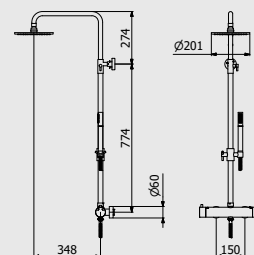

PORTATE | WATER FLOW | DÉBIT D'EAU

| | | |
|----------|--------|----------|
| 1 BAR | 2 BAR | 3 BAR |
| 11,2 l/m | 17 l/m | 21,2 l/m |

ARTICLE | ARTICOLO | ARTICLE

MT800



Milano Torino thermostatic shower column with shower kit
 Colonna doccia Milano Torino termostatica con kit doccia
 Milano Torino colonne de douche thermostatique avec kit douche

CODE / COEFFICIENT | CODICE /
 COEFFICIENTE | CODE / COEFFICIENT

CC MT800CC 28,3

PACKAGING

L: 1020 mm
 D: 490 mm
 H: 120 mm

3,4 kg

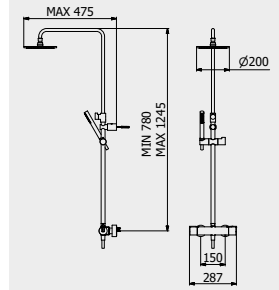

WATER FLOW | PORTATE | DÉBIT D'EAU

| | | |
|-------|--------|----------|
| 1 BAR | 2 BAR | 3 BAR |
| 9 l/m | 12 l/m | 14,5 l/m |

ARTICLE | ARTICOLO | ARTICLE

RU800



Rubacuori shower column thermostatic
 Colonna doccia Rubacuori termostatica
 Colonne de douche Rubacuori thermostatique

CODE / COEFFICIENT | CODICE /
 COEFFICIENTE | CODE / COEFFICIENT

CC RU800CC 33,2

PACKAGING

L: 1185 mm
 D: 415 mm
 H: 277 mm

4 kg

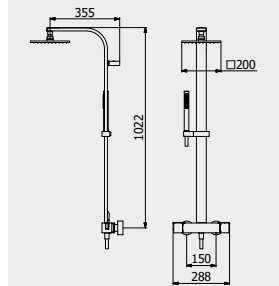

WATER FLOW | PORTATE | DÉBIT D'EAU

| | | |
|-------|--------|----------|
| 1 BAR | 2 BAR | 3 BAR |
| 8 l/m | 12 l/m | 14,5 l/m |

Shower
 columns

ARTICLE | ARTICOLO | ARTICLE

MA901



Floor standing indoor/outdoor shower column with showerhead
 Doccione monocomando da terra
 Colonne de douche du sol

CODE / COEFFICIENT | CODICE /
 COEFFICIENTE | CODE / COEFFICIENT

SS MA901SS 65,0

PACKAGING

L: 1250 mm
 D: 355 mm
 H: 245 mm

29 kg

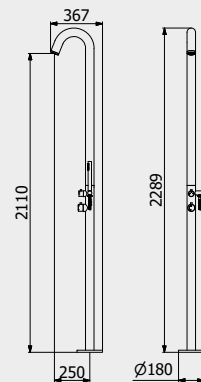

WATER FLOW | PORTATE | DÉBIT D'EAU

| 1 BAR | 2 BAR | 3 BAR |
|---------|---------|----------|
| 6,9 l/m | 9,9 l/m | 12,2 l/m |

ARTICLE | ARTICOLO | ARTICLE

MA525



Floor standing indoor/outdoor shower column with showerhead
 Doccione monocomando da terra
 Colonne de douche du sol



CODE / COEFFICIENT | CODICE /
 COEFFICIENTE | CODE / COEFFICIENT

CC MA525CC 45,0

ON MA525ON 45,0

PACKAGING

L: 1500 mm
 D: 535 mm
 H: 120 mm

15,1 kg



CODE / COEFFICIENT | CODICE /
 COEFFICIENTE | CODE / COEFFICIENT

CC MA526CC 45,6

ON MA526ON 45,6



CODE / COEFFICIENT | CODICE /
 COEFFICIENTE | CODE / COEFFICIENT

CC MA501CC 42,8

ON MA501ON 42,8

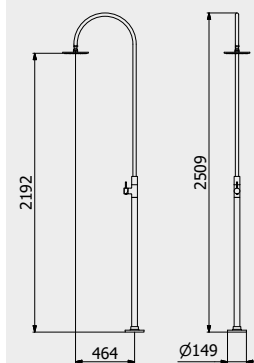

WATER FLOW | PORTATE | DÉBIT D'EAU

| 1 BAR | 2 BAR | 3 BAR |
|----------|----------|----------|
| 12,6 l/m | 18,1 l/m | 22,5 l/m |

Built-in body to be purchased separately
 AVAILABLE FROM JANUARY 2020

Corpo incasso da acquistare separatamente
 DISPONIBILE DA GENNAIO 2020

Corps intégré à acheter séparément
 DISPONIBLE À PARTIR DE JANVIER 2020



CODICE | CODE | CODE

INC399CCXN_19

COEFFICIENTE | COEFFICIENT | COEFFICIENT

2,8

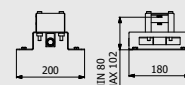

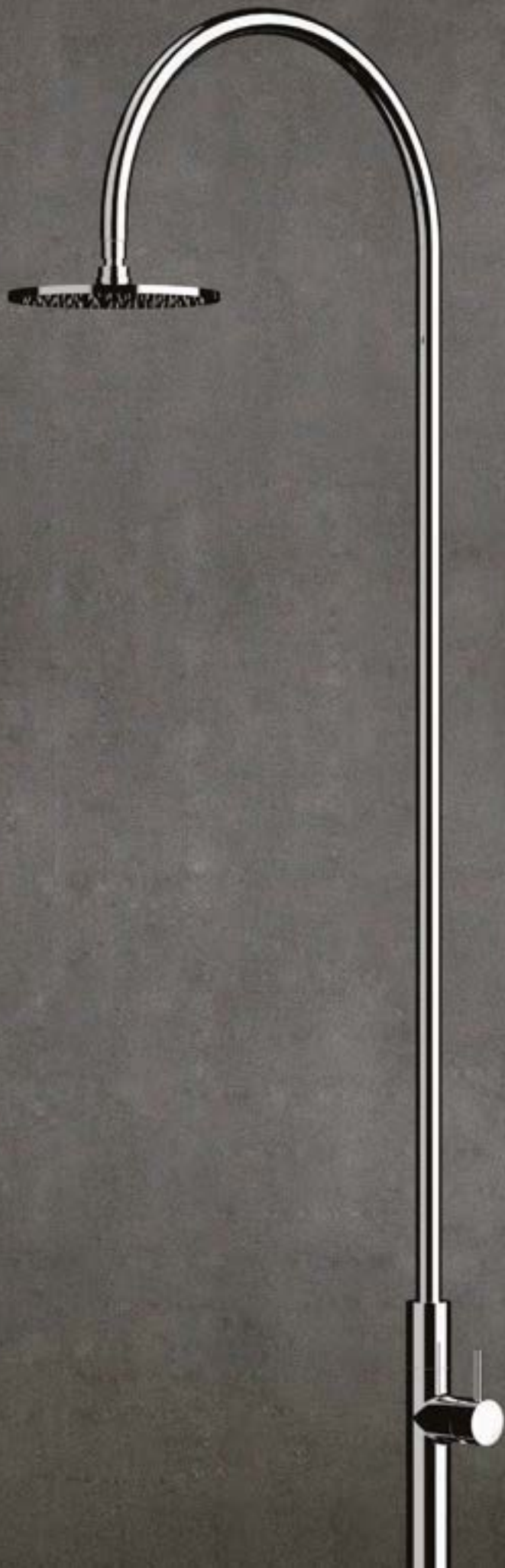

Shower
columns

Handshower

Soffioni Doccia e Doccette
Tetes de douche et douchette

ARTICLE | ARTICOLO | ARTICLE

SH001



Round brass handshower

Doccia tonda in ottone

Douche rond en laiton

| | | | |
|---|----|---------|-----|
| ● | CC | SH001CC | 1 |
| ● | SS | SH001SS | 1,3 |
| ● | BO | SH001BO | 1,2 |
| ● | NP | SH001NP | 1,3 |
| ● | CF | SH001CF | 1,5 |
| ● | CS | SH001CS | 1,6 |
| ● | OO | SH001OO | 1,5 |
| ● | II | SH001II | 1,5 |
| ● | IS | SH001IS | 1,6 |
| ● | RS | SH001RS | 1,5 |
| ● | SR | SH001SR | 1,6 |
| ● | OS | SH001OS | 1,6 |
| ● | BB | SH001BB | 1,4 |
| ● | RR | SH001RR | 1,4 |
| ● | ON | SH001ON | 1 |
| ● | PL | SH001PL | 1,6 |

PACKAGING

L: 280 mm
D: 130 mm
H: 70 mm

0,5 kg

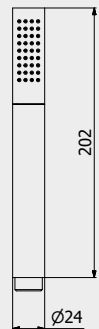

ARTICLE | ARTICOLO | ARTICLE

SH002



Square brass handshower

Doccia quadra in ottone

Douche carré en laiton

| | | | |
|---|----|---------|-----|
| ● | CC | SH002CC | 1,1 |
| ● | SS | SH002SS | 1,4 |
| ● | BO | SH002BO | 1,3 |
| ● | NP | SH002NP | 1,4 |
| ● | CF | SH002CF | 1,7 |
| ● | CS | SH002CS | 1,8 |
| ● | OO | SH002OO | 1,7 |
| ● | II | SH002II | 1,7 |
| ● | IS | SH002IS | 1,8 |
| ● | RS | SH002RS | 1,7 |
| ● | SR | SH002SR | 1,8 |
| ● | OS | SH002OS | 1,8 |
| ● | BB | SH002BB | 1,5 |
| ● | RR | SH002RR | 1,5 |
| ● | ON | SH002ON | 1,1 |
| ● | PL | SH002PL | 1,8 |

PACKAGING

L: 280 mm
D: 130 mm
H: 70 mm

0,5 kg

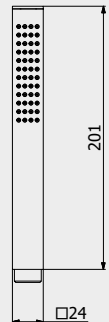

ARTICLE | ARTICOLO | ARTICLE

SH003



ABS multifunction handshower

Doccia ABS multifunzione

Douche ABS multifonctions

CODE / COEFFICIENT | CODICE /
COEFFICIENTE | CODE / COEFFICIENT

| | | | |
|---|----|---------|---|
| ● | CC | SH003CC | 1 |
|---|----|---------|---|

PACKAGING

L: 280 mm
D: 130 mm
H: 70 mm

0,7 kg

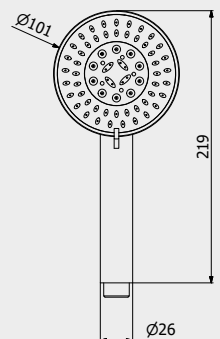

ARTICLE | ARTICOLO | ARTICLE

SH008



Square shower monojet SUMO
Doccetta quadra monogetto SUMO
Douchette carré à un jet SUMO

CODE / COEFFICIENT | CODICE /
COEFFICIENTE | CODE / COEFFICIENT

CC SH008CC 1

PACKAGING

L: 280 mm
D: 130 mm
H: 70 mm

0,7 kg

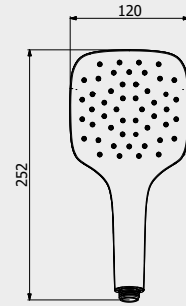

ARTICLE | ARTICOLO | ARTICLE

SH009



Square shower three jets SUMO
Doccetta quadra tre getti SUMO
Douchette carré à trois jets SUMO

CODE / COEFFICIENT | CODICE /
COEFFICIENTE | CODE / COEFFICIENT

CC SH009CC 1,2

PACKAGING

L: 280 mm
D: 130 mm
H: 70 mm

0,7 kg

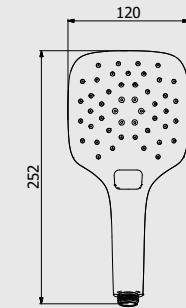

ARTICLE | ARTICOLO | ARTICLE

SH012



Round shower monojet CLEAN
Doccetta tonda monogetto CLEAN
Douchette ronde à un jet CLEAN

CODE / COEFFICIENT | CODICE /
COEFFICIENTE | CODE / COEFFICIENT

CC SH012CC 1

PACKAGING

L: 280 mm
D: 130 mm
H: 70 mm

0,7 kg

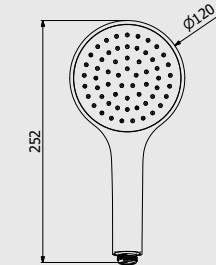

ARTICLE | ARTICOLO | ARTICLE

SH013



Round shower three jets CLEAN PLUS
Doccetta tonda tre getti CLEAN PLUS
Douchette ronde à trois jets CLEAN PLUS

CODE / COEFFICIENT | CODICE /
COEFFICIENTE | CODE / COEFFICIENT

CC SH013CC 1,2

PACKAGING

L: 280 mm
D: 130 mm
H: 70 mm

0,7 kg

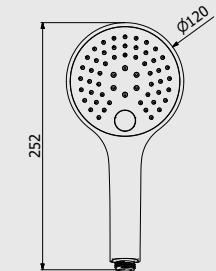

ARTICLE | ARTICOLO | ARTICLE

AA101



Round shower three jets CLEAN PLUS
Doccetta tonda tre getti CLEAN PLUS
Douchette ronde à trois jets CLEAN PLUS

CODE / COEFFICIENT | CODICE /
COEFFICIENTE | CODE / COEFFICIENT

CC AA101CC 1,8

PACKAGING

L: 280 mm
D: 130 mm
H: 70 mm

0,7 kg

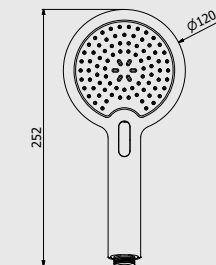



HANDSHOWER
P. 652



DUPLEX
P. 654



SHOWER RAIL
P. 658



BODYJET
P. 660



SHUT OFF
P. 662



STOP VALVES
P. 663



WATER OUTLET
P. 664



BOTTLE TRAP
P. 665

SHOWER&

CO.

Duplex

Duplex
Duplex

ARTICLE | ARTICOLO | ARTICLE

SH022



Duplex round - Round

Duplex tondo - Tondo

Duplex rond - Rond

| | | | |
|---|----|---------|-----|
| ● | CC | SH022CC | 3,1 |
| ● | SS | SH022SS | 3,9 |
| ● | BO | SH022BO | 3,7 |
| ● | NP | SH022NP | 3,9 |
| ● | CF | SH022CF | 4,7 |
| ● | CS | SH022CS | 5,0 |
| ● | OO | SH022OO | 4,7 |
| ● | II | SH022II | 4,7 |
| ● | IS | SH022IS | 5,0 |
| ● | RS | SH022RS | 4,7 |
| ● | SR | SH022SR | 5,0 |
| ● | OS | SH022OS | 5,0 |
| ● | BB | SH022BB | 4,3 |
| ● | RR | SH022RR | 4,3 |
| ● | ON | SH022ON | 3,1 |
| ● | PL | SH022PL | 5,0 |

PACKAGING

L: 280 mm
D: 260 mm
H: 70 mm

1,0 kg

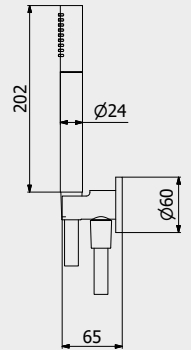

ARTICLE | ARTICOLO | ARTICLE

SH024



Duplex round - Square

Duplex tondo - Quadro

Duplex rond - Carré

| | | | |
|---|----|---------|-----|
| ● | CC | SH024CC | 3,1 |
| ● | SS | SH024SS | 3,9 |
| ● | BO | SH024BO | 3,7 |
| ● | NP | SH024NP | 3,9 |
| ● | CF | SH024CF | 4,7 |
| ● | CS | SH024CS | 5,0 |
| ● | OO | SH024OO | 4,7 |
| ● | II | SH024II | 4,7 |
| ● | IS | SH024IS | 5,0 |
| ● | RS | SH024RS | 4,7 |
| ● | SR | SH024SR | 5,0 |
| ● | OS | SH024OS | 5,0 |
| ● | BB | SH024BB | 4,3 |
| ● | RR | SH024RR | 4,3 |
| ● | ON | SH024ON | 3,1 |
| ● | PL | SH024PL | 5,0 |

PACKAGING

L: 280 mm
D: 260 mm
H: 70 mm

1,0 kg

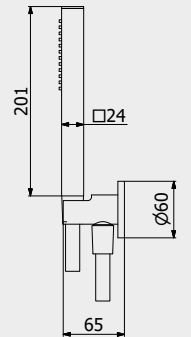

ARTICLE | ARTICOLO | ARTICLE

SH023



Duplex round - Multifunction

Duplex tondo - Multifunzione

Duplex rond - Multifonction

CODE / COEFFICIENT | CODICE /
COEFFICIENTE | CODE / COEFFICIENT

| | | | |
|---|----|---------|-----|
| ● | CC | SH023CC | 3,1 |
|---|----|---------|-----|

PACKAGING

L: 280 mm
D: 260 mm
H: 70 mm

1,0 kg

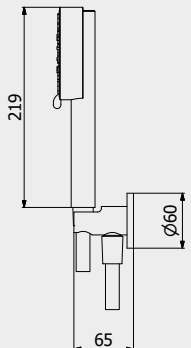

ARTICLE | ARTICOLO | ARTICLE

SH029



Duplex three jets SUMO
Duplex tre getti SUMO
Duplex à trois jets SUMO

| CODE / COEFFICIENT | CODICE / COEFFICIENTE | CODE / COEFFICIENT |
|--------------------|-----------------------|--------------------|
| CC | SH029CC | 3,1 |

PACKAGING

L: 280 mm
D: 260 mm
H: 70 mm

1,0 kg

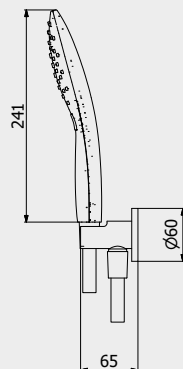

ARTICLE | ARTICOLO | ARTICLE

SH025



Duplex three jets CLEAN PLUS
Duplex tre getti CLEAN PLUS
Duplex à trois jets CLEAN PLUS

| CODE / COEFFICIENT | CODICE / COEFFICIENTE | CODE / COEFFICIENT |
|--------------------|-----------------------|--------------------|
| CC | SH025CC | 3,1 |

PACKAGING

L: 280 mm
D: 260 mm
H: 70 mm

1,0 kg

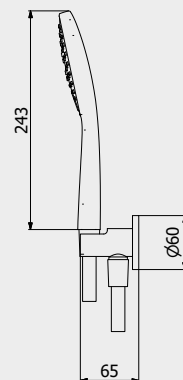

ARTICLE | ARTICOLO | ARTICLE

SH042



Duplex square
Duplex quadro
Duplex carré

| | | |
|----|---------|-----|
| CC | SH042CC | 3,2 |
| SS | SH042SS | 4,0 |
| BO | SH042BO | 3,8 |
| NP | SH042NP | 4,0 |
| CF | SH042CF | 4,8 |
| CS | SH042CS | 5,1 |
| OO | SH042OO | 4,8 |
| II | SH042II | 4,8 |
| IS | SH042IS | 5,1 |
| RS | SH042RS | 4,8 |
| SR | SH042SR | 5,1 |
| OS | SH042OS | 5,1 |
| BB | SH042BB | 4,5 |
| RR | SH042RR | 4,5 |
| ON | SH042ON | 3,2 |
| PL | SH042PL | 5,1 |

PACKAGING

L: 280 mm
D: 130 mm
H: 70 mm

1,2 kg

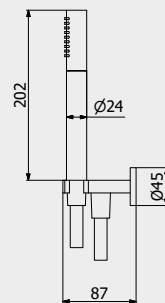

ARTICLE | ARTICOLO | ARTICLE

SH044



Duplex round - square
Duplex tondo - quadro
Duplex carré - Carré

| | | |
|----|---------|-----|
| CC | SH044CC | 3,2 |
| SS | SH044SS | 4,0 |
| BO | SH044BO | 3,8 |
| NP | SH044NP | 4,0 |
| CF | SH044CF | 4,8 |
| CS | SH044CS | 5,1 |
| OO | SH044OO | 4,8 |
| II | SH044II | 4,8 |
| IS | SH044IS | 5,1 |
| RS | SH044RS | 4,8 |
| SR | SH044SR | 5,1 |
| OS | SH044OS | 5,1 |
| BB | SH044BB | 4,5 |
| RR | SH044RR | 4,5 |
| ON | SH044ON | 3,2 |
| PL | SH044PL | 5,1 |

PACKAGING

L: 280 mm
D: 130 mm
H: 70 mm

1,2 kg

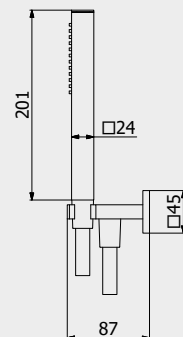

ARTICLE | ARTICOLO | ARTICLE

SH043

ABS



Duplex square - Multifunction
Duplex quadro - Multifunzione
Duplex carré - Multifonction

CODE / COEFFICIENT | CODICE /
COEFFICIENTE | CODE / COEFFICIENT

CC SH043CC 3,1

PACKAGING

L: 280 mm
D: 130 mm
H: 70 mm

1,2 kg

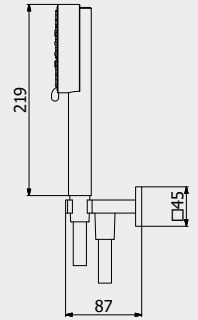

ARTICLE | ARTICOLO | ARTICLE

SH035

ABS



Duplex three jets SUMO
Duplex tre getti SUMO
Duplex à trois jets SUMO

CODE / COEFFICIENT | CODICE /
COEFFICIENTE | CODE / COEFFICIENT

CC SH035CC 3,1

PACKAGING

L: 280 mm
D: 130 mm
H: 70 mm

1,2 kg

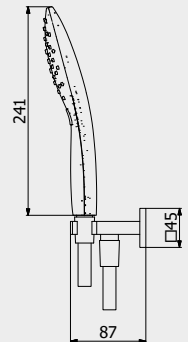

ARTICLE | ARTICOLO | ARTICLE

SH028

ABS



Duplex three jets CLEAN PLUS
Duplex tre getti CLEAN PLUS
Duplex à trois jets CLEAN PLUS

CODE / COEFFICIENT | CODICE /
COEFFICIENTE | CODE / COEFFICIENT

CC SH028CC 3,1

PACKAGING

L: 280 mm
D: 260 mm
H: 70 mm

1,0 kg

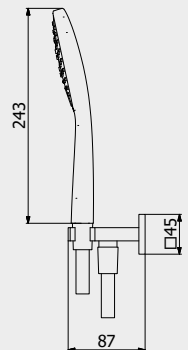

ARTICLE | ARTICOLO | ARTICLE

SH045

Pb



Duplex Belmondo
Duplex Belmondo
Duplex Belmondo

CODE / COEFFICIENT | CODICE /
COEFFICIENTE | CODE / COEFFICIENT

CC SH045CC 6,1

OO SH045OO 9,1

II SH045II 9,1

RS SH045RS 9,1

PL SH045PL 9,8

PACKAGING

L: 280 mm
D: 130 mm
H: 70 mm

1,7 kg

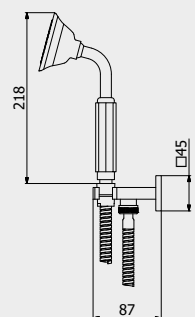

ARTICOLO | ARTICLE | ARTICLE

HR046



Duplex HERMES
Duplex HERMES
Duplex HERMES

| COEFFICIENT | CODICE / COEFFICIENTE | COEFFICIENT |
|-------------|-----------------------|-------------|
| CC | HR046CC | 4,0 |
| PL | HR046PL | 6,4 |
| SS | HR046SS | 5,0 |
| II | HR046II | 6,0 |
| RS | HR046RS | 6,0 |
| OS | HR046OS | 6,4 |
| RR | HR046RR | 5,6 |
| BB | HR046BB | 5,6 |

PACKAGING

L: 280 mm
D: 130 mm
H: 70 mm
1,2 kg

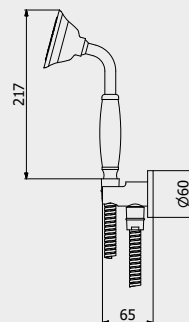

ARTICLE | ARTICOLO | ARTICLE

MR022



Duplex MARMO
Duplex MARMO
Duplex MARMO

| COEFFICIENT | CODICE / COEFFICIENTE | COEFFICIENT |
|-------------|-----------------------|-------------|
|-------------|-----------------------|-------------|

| | | |
|----|---------------------|------|
| CC | MR022CC_1 MR022CC_2 | 8,6 |
| PL | MR022PL_1 MR022PL_2 | 13,8 |
| SS | MR022SS_1 MR022SS_2 | 10,8 |
| ON | MR022ON_1 MR022ON_2 | 8,6 |
| BO | MR022BO_1 MR022BO_2 | 10,3 |
| NP | MR022NP_1 MR022NP_2 | 10,3 |
| CF | MR022CF_1 MR022CF_2 | 12,9 |
| CS | MR022CS_1 MR022CS_2 | 13,8 |
| II | MR022II_1 MR022II_2 | 12,9 |
| IS | MR022IS_1 MR022IS_2 | 13,8 |
| RS | MR022RS_1 MR022RS_2 | 12,9 |
| SR | MR022SR_1 MR022SR_2 | 13,8 |
| OO | MR022OO_1 MR022OO_2 | 12,9 |
| OS | MR022OS_1 MR022OS_2 | 13,8 |

PACKAGING

L: 360 mm
D: 220 mm
H: 150 mm
1,8 kg

MARBLE

White Carrara
Black Marquina

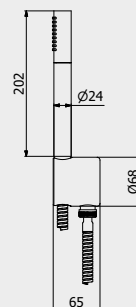

ARTICLE | ARTICOLO | ARTICLE

AA024



Duplex TAAAC
Duplex TAAAC
Duplex TAAAC

| COEFFICIENT | CODICE / COEFFICIENTE | COEFFICIENT |
|-------------|-----------------------|-------------|
| CC | AA024CC | 3,5 |
| SS | AA024SS | 4,4 |
| BO | AA024BO | 4,4 |
| NP | AA024NP | 4,4 |

PACKAGING

L: 265 mm
D: 260 mm
H: 70 mm
1,4 kg

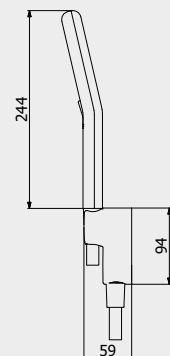

ARTICLE | ARTICOLO | ARTICLE

B2022



Duplex
Duplex
Duplex

| COEFFICIENT | CODICE / COEFFICIENTE | COEFFICIENT |
|-------------|-----------------------|-------------|
| CC | B2022CC | 6,3 |
| SS | B2022SS | 7,9 |
| ON | B2022ON | 6,3 |
| NP | B2022NP | 7,9 |
| CF | B2022CF | 9,5 |
| CS | B2022CS | 10,1 |
| II | B2022II | 9,5 |
| IS | B2022IS | 10,1 |
| RS | B2022RS | 9,5 |
| SR | B2022SR | 10,1 |
| OO | B2022OO | 9,5 |
| OS | B2022OS | 10,1 |

PACKAGING

L: 340 mm
D: 180 mm
H: 70 mm
1,0 kg

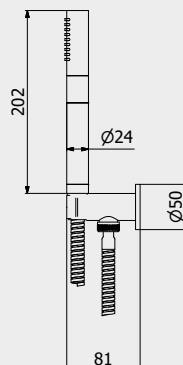

Shower & Co

Shower rail

Saliscendi
Loquets

ARTICLE | ARTICOLO | ARTICLE

SH100

ABS



Multifunction shower rail set

Saliscendi Multifunzione

Loquet multifonctions

CODE / COEFFICIENT | CODICE /
COEFFICIENTE | CODE / COEFFICIENT

● CC SH100CC 2,5

PACKAGING

📦 L: 810 mm
D: 430 mm
H: 465 mm

⚖️ 1,8 kg

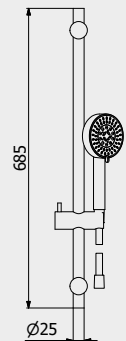

ARTICLE | ARTICOLO | ARTICLE

SH101

ABS



Multifunction shower rail with soap holder

Saliscendi Multifunzione con piatto porta sapone

Loquet multifonctions avec porte savon plat

CODE / COEFFICIENT | CODICE /
COEFFICIENTE | CODE / COEFFICIENT

● CC SH101CC 2,6

PACKAGING

📦 L: 810 mm
D: 430 mm
H: 465 mm

⚖️ 1,8 kg

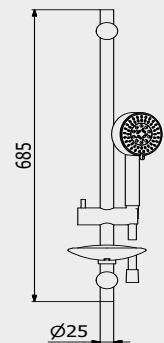

ARTICLE | ARTICOLO | ARTICLE

SH102

Pb



Hermes shower rail

Saliscendi Hermes

Loquet Hermes

● CC SH102CC 7,9

● SS SH102SS 9,9

● II SH102II 11,9

● RS SH102RS 11,9

● OS SH102OS 12,6

● BB SH102BB 11,1

● RR SH102RR 11,1

● PL SH102PL 12,6

PACKAGING

📦 L: 810 mm
D: 430 mm
H: 465 mm

⚖️ 1,8 kg

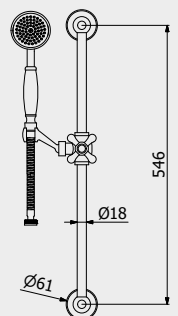

ARTICLE | ARTICOLO | ARTICLE

SH109



Shower rail three jets SUMO

Saliscendi tre getti SUMO

Loquet à trois jets SUMO

CODE / COEFFICIENT | CODICE /
COEFFICIENTE | CODE / COEFFICIENT

CC SH109CC 4,9

PACKAGING

L: 810 mm
D: 430 mm
H: 465 mm

1,8 kg

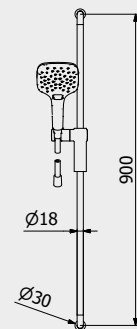

ARTICLE | ARTICOLO | ARTICLE

SH111



Shower rail three jets CLEAN PLUS

Saliscendi tre getti CLEAN PLUS

Loquet à trois jets CLEAN PLUS

CODE / COEFFICIENT | CODICE /
COEFFICIENTE | CODE / COEFFICIENT

CC SH111CC 4,8

PACKAGING

L: 810 mm
D: 430 mm
H: 465 mm

1,8 kg

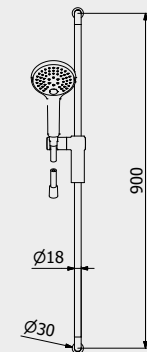

ARTICLE | ARTICOLO | ARTICLE

AA100



Shower rail TAAC

Saliscendi TAAAC

Loquet multifonctions TAAAC

CODE / COEFFICIENT | CODICE /
COEFFICIENTE | CODE / COEFFICIENT

CC AA100CC 6,3

SS AA100SS 7,9

PACKAGING

L: 965 mm
D: 175 mm
H: 195 mm

1,4 kg

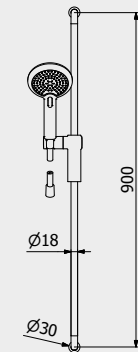

Shower
& Co

Bodyjet

Bodyjet
Bodyjet

ARTICLE | ARTICOLO | ARTICLE

SH030



Square Body - jet

Getto laterale quadro

Body - Jet carré

| | | |
|------|---------|-----|
| ● CC | SH030CC | 2 |
| ● SS | SH030SS | 2,5 |
| ● BO | SH030BO | 2,4 |
| ● NP | SH030NP | 2,5 |
| ● CF | SH030CF | 3,0 |
| ● CS | SH030CS | 3,2 |
| ● OO | SH030OO | 3,0 |
| ● II | SH030II | 3,0 |
| ● IS | SH030IS | 3,2 |
| ● RS | SH030RS | 3,0 |
| ● SR | SH030SR | 3,2 |
| ● OS | SH030OS | 3,2 |
| ● BB | SH030BB | 2,8 |
| ● RR | SH030RR | 2,8 |
| ● ON | SH030ON | 1,8 |
| ● PL | SH030PL | 3,2 |

PACKAGING

L: 280 mm
D: 130 mm
H: 70 mm

0,2 kg

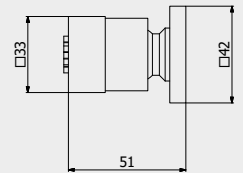

ARTICLE | ARTICOLO | ARTICLE

SH031



Round Body - jet

Getto laterale tondo

Body - Jet rond

| | | |
|------|---------|-----|
| ● CC | SH031CC | 1,4 |
| ● SS | SH031SS | 1,8 |
| ● BO | SH031BO | 1,7 |
| ● NP | SH031NP | 1,8 |
| ● CF | SH031CF | 2,1 |
| ● CS | SH031CS | 2,2 |
| ● OO | SH031OO | 2,1 |
| ● II | SH031II | 2,1 |
| ● IS | SH031IS | 2,2 |
| ● RS | SH031RS | 2,1 |
| ● SR | SH031SR | 2,2 |
| ● OS | SH031OS | 2,2 |
| ● BB | SH031BB | 2,0 |
| ● RR | SH031RR | 2,0 |
| ● ON | SH031ON | 2,8 |
| ● PL | SH031PL | 2,2 |

PACKAGING

L: 280 mm
D: 130 mm
H: 70 mm

0,2 kg

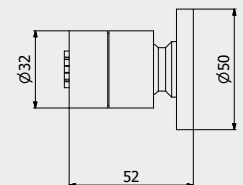

ARTICLE | ARTICOLO | ARTICLE

SH032



Hermes Body - jet

Getto laterale Hermes

Body - jet Hermes

| | | |
|------|---------|-----|
| ● CC | SH032CC | 1,5 |
| ● SS | SH032SS | 1,9 |
| ● BO | SH032BO | 1,8 |
| ● NP | SH032NP | 1,9 |
| ● CF | SH032CF | 2,3 |
| ● CS | SH032CS | 2,4 |
| ● OO | SH032OO | 2,3 |
| ● II | SH032II | 2,3 |
| ● IS | SH032IS | 2,4 |
| ● RS | SH032RS | 2,3 |
| ● SR | SH032SR | 2,4 |
| ● OS | SH032OS | 2,4 |
| ● BB | SH032BB | 2,1 |
| ● RR | SH032RR | 2,1 |
| ● ON | SH032ON | 3,8 |
| ● PL | SH032PL | 2,4 |

PACKAGING

L: 280 mm
D: 130 mm
H: 70 mm

0,2 kg

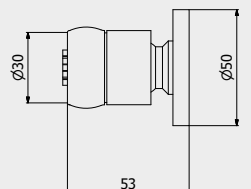

ARTICLE | ARTICOLO | ARTICLE

SH033



Square built-in Body - jet
 Getto laterale incasso quadro
 Body-Jet encastré carré

| CODE / COEFFICIENT | CODICE / COEFFICIENTE | |
|--------------------|-----------------------|-----|
| CC | SH033CC | 3,7 |

PACKAGING

L: 150 mm
 D: 190 mm
 H: 98 mm

0,8 kg

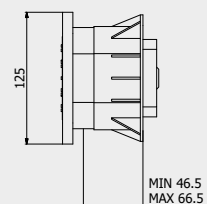

ARTICLE | ARTICOLO | ARTICLE

SH034



Round built-in Body - jet
 Getto laterale incasso tondo
 Body-Jet encastré rond

| CODE / COEFFICIENT | CODICE / COEFFICIENTE | |
|--------------------|-----------------------|-----|
| CC | SH034CC | 3,7 |

PACKAGING

L: 150 mm
 D: 190 mm
 H: 98 mm

0,8 kg

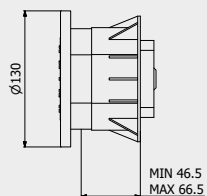

ARTICLE | ARTICOLO | ARTICLE

SH014



Round lateral Body - jet spray
 Getto laterale fisso tondo nebulizzatore
 Body-jet lateral rond pulverisation

| | | |
|----|---------|-----|
| CC | SH014CC | 3,4 |
| SS | SH014SS | 4,3 |
| BO | SH014BO | 4,1 |
| NP | SH014NP | 4,3 |
| CF | SH014CF | 5,1 |
| CS | SH014CS | 5,4 |
| OO | SH014OO | 5,1 |
| II | SH014II | 5,1 |
| IS | SH014IS | 5,4 |
| RS | SH014RS | 5,1 |
| SR | SH014SR | 5,4 |
| OS | SH014OS | 5,4 |
| BB | SH014BB | 4,8 |
| RR | SH014RR | 4,8 |
| ON | SH014ON | 3,4 |
| PL | SH014PL | 5,4 |

PACKAGING

L: 280 mm
 D: 130 mm
 H: 70 mm

0,5 kg

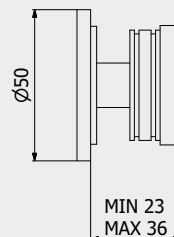

Shower & Co

Shut off

Idroscopini

Ensemble hygiénique

ARTICLE | ARTICOLO | ARTICLE

SH067



Metal shut off with chromolux flexible

Idroscopino metal con chromolux

Ensemble Hygiénique metal avec chromolux

| | | | |
|---|----|---------|-----|
| ● | CC | SH067CC | 5,0 |
| ● | SS | SH067SS | 6,3 |
| ● | BO | SH067BO | 6,0 |
| ● | NP | SH067NP | 6,3 |
| ● | CF | SH067CF | 7,5 |
| ● | CS | SH067CS | 8,0 |
| ● | OO | SH067OO | 7,5 |
| ● | II | SH067II | 7,5 |
| ● | IS | SH067IS | 8,0 |
| ● | RS | SH067RS | 7,5 |
| ● | SR | SH067SR | 8,0 |
| ● | OS | SH067OS | 8,0 |
| ● | BB | SH067BB | 7,0 |
| ● | RR | SH067RR | 7,0 |
| ● | ON | SH067ON | 5,0 |
| ● | PL | SH067PL | 8,0 |

PACKAGING

L: 150 mm
 D: 100 mm
 H: 60 mm

0,6 kg

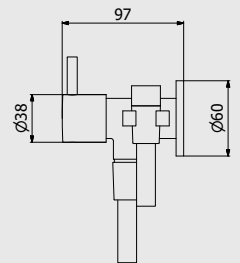

ARTICLE | ARTICOLO | ARTICLE

SH070



Easy shut off with long chromolux flexible

Idroscopino easy con flessibile doppia aggraffatura

Ensemble Hygiénique easy avec flexible

CODE / COEFFICIENTE | CODICE /
COEFFICIENTE | CODE / COEFFICIENT

| | | | |
|---|----|---------|-----|
| ● | CC | SH070CC | 0,7 |
|---|----|---------|-----|

PACKAGING

L: 280 mm
 D: 130 mm
 H: 70 mm

1,4 kg

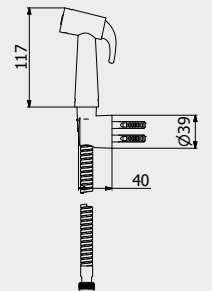

!



IN ORDER TO CONSULT THE BIDET SPRAYERS (CODE 706), PLEASE REFER TO EACH BATHROOM COLLECTION.
PER LA CONSULTAZIONE DEGLI IDROSCOPINI (CODICE 706) SI RIMANDA AD OGNI COLLEZIONE BAGNO
POUR LA CONSULTATION DES DOUCHETTES BIDET (CODE 706) FAIRE RÉFÉRENCE À CHAQUE COLLECTION DE BAIN.



Stop valves

Rubinetti d'arresto
Commandes d'arrêt

ARTICLE | ARTICOLO | ARTICLE

SH010



Round stop valves (two pieces)

Coppia rubinetti sottolavabo tondi

Paire de robinets ronds

CODE / COEFFICIENT | CODICE /
COEFFICIENTE | CODE / COEFFICIENT

| | | |
|----|---------|-----|
| CC | SH010CC | 1,3 |
| SS | SH010SS | 1,6 |
| BO | SH010BO | 1,5 |
| NP | SH010NP | 1,6 |
| CF | SH010CF | 1,9 |
| CS | SH010CS | 2,0 |
| OO | SH010OO | 1,9 |
| II | SH010II | 1,9 |
| IS | SH010IS | 2,0 |
| RS | SH010RS | 1,9 |
| SR | SH010SR | 2,0 |
| OS | SH010OS | 2,0 |
| BB | SH010BB | 1,8 |
| RR | SH010RR | 1,8 |
| ON | SH010ON | 1,8 |
| PL | SH010PL | 2,0 |

PACKAGING

L: 280 mm
D: 130 mm
H: 70 mm

0,4 kg

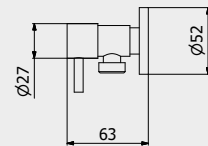

ARTICLE | ARTICOLO | ARTICLE

SH011



Square stop valves (two pieces)

Coppia rubinetti sottolavabo quadri

Paire de robinets carré

CODE / COEFFICIENT | CODICE /
COEFFICIENTE | CODE / COEFFICIENT

| | | |
|----|---------|-----|
| CC | SH011CC | 1,5 |
|----|---------|-----|

PACKAGING

L: 280 mm
D: 130 mm
H: 70 mm

0,8 kg

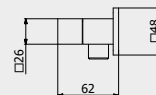

Water outlet

Prese d'acqua
Prise d'eau

ARTICLE | ARTICOLO | ARTICLE

SH060



Cilindrical water outlet

Pres a acqua tonda

Prise d'eau rond

| | | | |
|---|----|---------|-----|
| ● | CC | SH060CC | 1,5 |
| ● | SS | SH060SS | 1,9 |
| ● | BO | SH060BO | 1,8 |
| ● | NP | SH060NP | 1,9 |
| ● | CF | SH060CF | 2,3 |
| ● | CS | SH060CS | 2,4 |
| ● | OO | SH060OO | 2,3 |
| ● | II | SH060II | 2,3 |
| ● | IS | SH060IS | 2,4 |
| ● | RS | SH060RS | 2,3 |
| ● | SR | SH060SR | 2,4 |
| ● | OS | SH060OS | 2,4 |
| ● | BB | SH060BB | 2,1 |
| ● | RR | SH060RR | 2,1 |
| ● | ON | SH060ON | 1,8 |
| ● | PL | SH060PL | 2,4 |

PACKAGING

L: 150 mm
D: 100 mm
H: 60 mm

0,5 kg

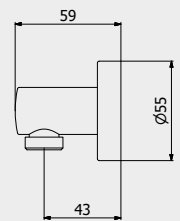

ARTICLE | ARTICOLO | ARTICLE

SH061



Square water outlet

Pres a acqua quadra

Prise d'eau carré

| | | | |
|---|----|---------|-----|
| ● | CC | SH061CC | 2,5 |
| ● | SS | SH061SS | 3,1 |
| ● | BO | SH061BO | 3,0 |
| ● | NP | SH061NP | 3,1 |
| ● | CF | SH061CF | 3,8 |
| ● | CS | SH061CS | 4,0 |
| ● | OO | SH061OO | 3,8 |
| ● | II | SH061II | 3,8 |
| ● | IS | SH061IS | 4,0 |
| ● | RS | SH061RS | 3,8 |
| ● | SR | SH061SR | 4,0 |
| ● | OS | SH061OS | 4,0 |
| ● | BB | SH061BB | 3,5 |
| ● | RR | SH061RR | 3,5 |
| ● | ON | SH061ON | 2,8 |
| ● | PL | SH061PL | 4,0 |

PACKAGING

L: 150 mm
D: 100 mm
H: 60 mm

0,5 kg

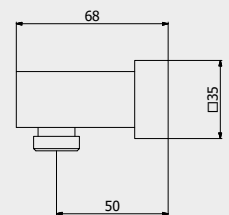

Bottle trap

Sifoni
Siphons

ARTICLE | ARTICOLO | ARTICLE

SH080



Round bottle trap

Sifone tondo

Siphon rond

| | | |
|------|---------|-----|
| ● CC | SH080CC | 4,5 |
| ● SS | SH080SS | 5,6 |
| ● BO | SH080BO | 5,4 |
| ● NP | SH080NP | 5,6 |
| ● CF | SH080CF | 6,8 |
| ● CS | SH080CS | 7,2 |
| ● OO | SH080OO | 6,8 |
| ● II | SH080II | 6,8 |
| ● IS | SH080IS | 7,2 |
| ● RS | SH080RS | 6,8 |
| ● SR | SH080SR | 7,2 |
| ● OS | SH080OS | 7,2 |
| ● BB | SH080BB | 6,3 |
| ● RR | SH080RR | 6,3 |
| ● ON | SH080ON | 4,5 |
| ● PL | SH080PL | 7,2 |

PACKAGING

L: 340 mm
D: 180 mm
H: 70 mm

1,0 kg

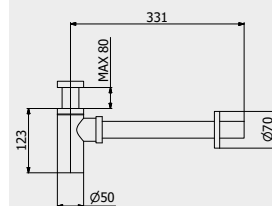

ARTICLE | ARTICOLO | ARTICLE

SH081



Square bottle trap

Sifone quadro

Siphon carré

| | | |
|------|---------|-----|
| ● CC | SH081CC | 4,7 |
| ● SS | SH081SS | 5,9 |
| ● BO | SH081BO | 5,6 |
| ● NP | SH081NP | 5,9 |
| ● CF | SH081CF | 7,1 |
| ● CS | SH081CS | 7,5 |
| ● OO | SH081OO | 7,1 |
| ● II | SH081II | 7,1 |
| ● IS | SH081IS | 7,5 |
| ● RS | SH081RS | 7,1 |
| ● SR | SH081SR | 7,5 |
| ● OS | SH081OS | 7,5 |
| ● BB | SH081BB | 6,6 |
| ● RR | SH081RR | 6,6 |
| ● ON | SH081ON | 4,7 |
| ● PL | SH081PL | 7,5 |

PACKAGING

L: 340 mm
D: 180 mm
H: 70 mm

1,0 kg

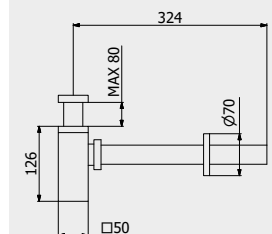

ARTICLE | ARTICOLO | ARTICLE

SH082



EASY bottle trap

Sifone EASY

Siphon EASY

CODE / COEFFICIENT | CODICE /
COEFFICIENTE | CODE / COEFFICIENT

| | | |
|------|---------|-----|
| ● CC | SH082CC | 1,5 |
|------|---------|-----|

PACKAGING

L: 340 mm
D: 180 mm
H: 70 mm

0,9 kg

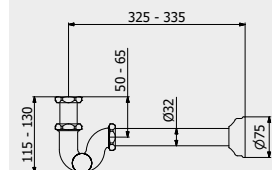

Shower
& Co



ACCIAIO
P. 668



LOFT
P. 676



KITCHEN
P. 682

KC

**KITCHEN
CUCINA
CUISINE**

ACCIAIO

The form becomes an emblem for high professionalism.

La forma si fa simbolo di alta professionalità ed efficienza.
La forme devient emblème de haut professionnalisme

The ACCIAIO collection draws inspiration from a linear aesthetics and an innovative technology, blending together just like in a professional kitchen.

The clean and modern form, elegant in its sobriety, is nothing but the mirror of a all-round technological product, consisting of pull-out hand shower, moving spring and complete rotation, which guarantee the best procedures in an elegant and sophisticated environment, where the form becomes an emblem for high professionalism and efficiency.

La collezione ACCIAIO si ispira alla fusione tra un'estetica lineare e una tecnologia innovativa, tipica delle migliori cucine professionali. La pulizia e modernità della forma, elegante nella sua sobrietà, non è altro che lo specchio di un prodotto completo e tecnologico, composto da doccetta estraibile, molla di movimento e da una rotazione completa, per garantire le migliori pratiche in un ambiente dall'elegante tocco estetico, in cui la forma si fa simbolo di alta professionalità ed efficienza.

La collection ACCIAIO s'inspire de la fusion entre une esthétique linéaire et une technologie innovante, typique des meilleures cuisines professionnelles. La pureté et modernité de la forme, élégante dans sa sobriété, n'est que le miroir d'un produit hautement technologique, composé d'une douchette extractible, d'un ressort de mouvement et d'une rotation complète, qui garantit les meilleures pratiques dans un environnement à la touche esthétique raffinée, où la forme devient emblème de haut professionnalisme et efficacité.



LEAD FREE



ZINC FREE



ROTATING









← AC386
Lateral lever spring sink mixer
Lavello leva laterale con molla
Évier de cuisine à ressort et levier latéral

↑ AC381
Lateral lever and extractible shower sink mixer
Lavello Monoforo doccetta estraibile leva laterale
Évier de cuisine avec douchette extractible et levier latéral



Acciaio



↑ AC385
→ Lateral lever sink mixer
Lavello leva laterale
Évier de cuisine avec levier latéral

↙ AC382
Lateral lever and extractible shower sink mixer
Lavello Monoforo doccetta estraibile leva
laterale
Évier de cuisine avec douchette extractible et
levier latéral





ARTICLE | ARTICOLO | ARTICLE

AC381



Lateral lever and extractible shower sink mixer

Lavello Monoforo doccetta estraibile leva laterale

Évier de cuisine avec douchette extractible et levier latéral

CODICE / COEFFICIENTE | CODICE / COEFFICIENTE

SS AC381SS 25,5

PACKAGING

L: 685 mm
D: 345 mm
H: 168 mm

3,0 kg

NB: Faucet entirely in stainless steel /
Rubinetto interamente in acciaio
inossidabile / Robinet tout en
acier inoxydable

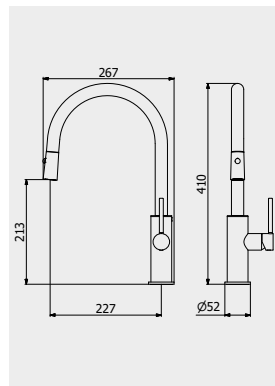

PORTATE | WATER FLOW | DÉBIT D'EAU

| 1 BAR | 2 BAR | 3 BAR |
|-------|---------|---------|
| 6 l/m | 7,5 l/m | 9,5 l/m |

ARTICLE | ARTICOLO | ARTICLE

AC382



Lateral lever and extractible shower sink mixer

Lavello Monoforo doccetta estraibile leva laterale

Évier de cuisine avec douchette extractible et levier latéral

CODICE / COEFFICIENTE | CODICE / COEFFICIENTE

SS AC382SS 25,1

PACKAGING

L: 685 mm
D: 345 mm
H: 168 mm

2,7 kg

NB: Faucet entirely in stainless steel /
Rubinetto interamente in acciaio
inossidabile / Robinet tout en
acier inoxydable

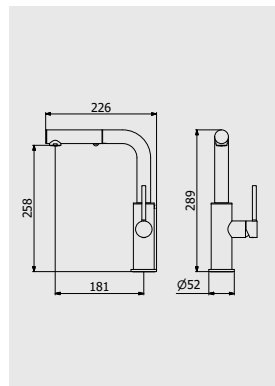

PORTATE | WATER FLOW | DÉBIT D'EAU

| 1 BAR | 2 BAR | 3 BAR |
|-------|---------|---------|
| 6 l/m | 7,5 l/m | 9,5 l/m |

ARTICLE | ARTICOLO | ARTICLE

AC385



Lateral lever sink mixer

Lavello leva laterale

Évier de cuisine avec levier latéral

CODICE / COEFFICIENTE | CODICE / COEFFICIENTE

SS AC385SS 20,2

PACKAGING

L: 685 mm
D: 345 mm
H: 168 mm

2,8 kg

NB: Faucet entirely in stainless steel /
Rubinetto interamente in acciaio
inossidabile / Robinet tout en
acier inoxydable

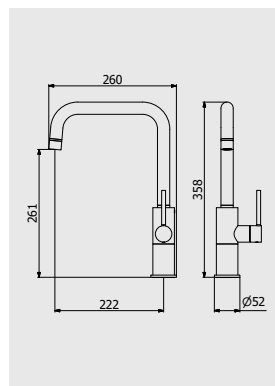

PORTATE | WATER FLOW | DÉBIT D'EAU

| 1 BAR | 2 BAR | 3 BAR |
|-------|---------|---------|
| 6 l/m | 7,5 l/m | 9,5 l/m |

ARTICLE | ARTICOLO | ARTICLE

AC386



Lateral lever spring sink mixer

Lavello leva laterale con molla

Évier de cuisine à ressort et levier latéral

CODICE / COEFFICIENTE | CODICE / COEFFICIENTE

SS AC386SS 28,5

PACKAGING

L: 685 mm
D: 345 mm
H: 168 mm

3,4 kg

NB: Faucet entirely in stainless steel /
Rubinetto interamente in acciaio
inossidabile / Robinet tout en
acier inoxydable

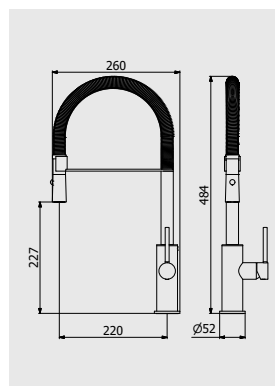

PORTATE | WATER FLOW | DÉBIT D'EAU

| 1 BAR | 2 BAR | 3 BAR |
|-------|---------|---------|
| 6 l/m | 7,5 l/m | 9,5 l/m |

Acciaio

LOFT

The boundless modern kitchen style.

Lo stile della cucina moderna senza confini.
Le style de cuisine moderne sans bornes.

Wide open rooms, clean and elegant lines, the modern style of bright and boundless spaces: LOFT collection draws inspiration from the elegant lofts of contemporary cities, reinterpreted in the form of kitchen faucets with a modern and sophisticated look. The avant-garde technology, which includes pull-out hand shower, moving spring and complete rotation, matches with a linear and elegant look and with chromed finishes, adding even more refinement to this high-class product.

Gli ampi spazi aperti, le linee pulite ed eleganti, lo stile moderno di uno spazio luminoso e senza limiti: la collezione LOFT trae ispirazione dalle eleganti abitazioni delle città moderne, reinterprestandole nella forma di rubinetti per cucina dall'aspetto moderno e ricercato. La tecnologia d'avanguardia, che include doccetta estraibile, molla di movimento e rotazione completa, è appaiata a un'estetica lineare ed elegante, completa di finiture cromate che aggiungono un'ancora maggiore ricercatezza a questo prodotto di alta classe.

Les grands espaces, les lignes pures et élégantes, le style moderne d'un milieu lumineux et illimité: la collection LOFT s'inspire des élégantes demeures de la ville moderne, pour les réinterpréter sous forme de robinets de cuisine aux traits modernes et sophistiqués. La technologie d'avant-garde, composée par une douchette extractible, un ressort de mouvement et une rotation complète, est associée à une esthétique linéaire et élégante, complétée par des finitions chromées qui ajoutent encore plus de raffinement à ce produit haut de gamme.



LEAD FREE



ZINC FREE



ROTATING









← L0386
Lateral lever spring sink mixer
Lavello leva laterale con molla
Évier de cuisine à ressort et levier latéral

↑ L0381
Lateral lever and extractible shower sink mixer
Lavello Monoforo doccetta estraibile leva laterale
Évier de cuisine avec douchette extractible et levier latéral

→ L0382
Lateral lever and extractible shower sink mixer
Lavello Monoforo doccetta estraibile leva laterale
Évier de cuisine avec douchette extractible et levier latéral





ARTICLE | ARTICOLO | ARTICLE

L0381



Lateral lever and extractable shower sink mixer

Lavello Monoforo doccetta estraibile leva laterale

Évier de cuisine avec douchette extractible et levier latéral

CODE / COEFFICIENT | CODICE /
COEFFICIENTE | CODE / COEFFICIENT

SS L0381SS 16,8

PACKAGING

L: 675 mm
D: 320 mm
H: 80 mm

3,6 kg

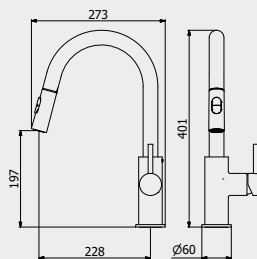

PORTATE | WATER FLOW | DÉBIT D'EAU

| | | |
|-------|---------|---------|
| 1 BAR | 2 BAR | 3 BAR |
| 3 l/m | 4,4 l/m | 4,5 l/m |

ARTICLE | ARTICOLO | ARTICLE

L0382



Lateral lever and extractable shower sink mixer

Lavello Monoforo doccetta estraibile leva laterale

Évier de cuisine avec douchette extractible et levier latéral

CODE / COEFFICIENT | CODICE /
COEFFICIENTE | CODE / COEFFICIENT

SS L0382SS 7,1

PACKAGING

L: 675 mm
D: 320 mm
H: 80 mm

2,3 kg

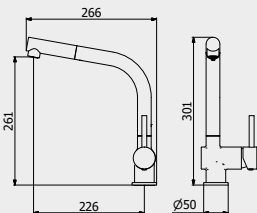

PORTATE | WATER FLOW | DÉBIT D'EAU

| | | |
|-------|---------|---------|
| 1 BAR | 2 BAR | 3 BAR |
| 3 l/m | 4,4 l/m | 4,5 l/m |

ARTICLE | ARTICOLO | ARTICLE

L0386



Lateral lever spring sink mixer

Lavello leva laterale con molla

Évier de cuisine à ressort et levier latéral

CODE / COEFFICIENT | CODICE /
COEFFICIENTE | CODE / COEFFICIENT

SS L0386SS 21,0

PACKAGING

L: 675 mm
D: 320 mm
H: 80 mm

4,2 kg

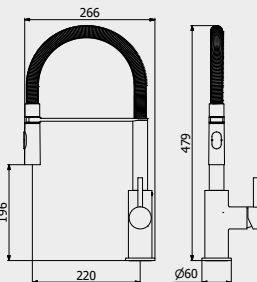

PORTATE | WATER FLOW | DÉBIT D'EAU

| | | |
|-------|---------|---------|
| 1 BAR | 2 BAR | 3 BAR |
| 3 l/m | 4,4 l/m | 4,5 l/m |

KITCHEN

One for all or all for one.

Uno per tutti o tutti per uno.
Un pour tous ou tous pour un.

If you are looking for harmony and continuity in your home, the KITCHEN collection is what you need. KITCHEN reproduces the best IB Bathroom faucet collections' aesthetics, in a version functionally and aesthetically updated to your kitchen, guaranteeing a home always coordinated and efficient, able to balance aesthetic and practical continuity, harmony and proportion in every room of your home.

Se ricerchi armonia e continuità nel tuo spazio casalingo, la collezione KITCHEN è quella adatta alla tua cucina. Kitchen ripropone l'estetica delle migliori collezioni IB Rubinetti per bagno, in una versione adattata alla funzionalità e all'estetica della cucina, per garantire una casa sempre coordinata ed efficiente, in un rapporto di continuità estetica e pratica che garantirà equilibrio, sintonia e proporzione in ogni ambiente della tua abitazione.

Si vous recherchez l'harmonie et la continuité dans votre milieu domestique, la collection KITCHEN est celle qui convient à votre cuisine. Kitchen reproduit l'esthétique des meilleures collections pour salle de bains de IB Rubinetti, dans une version adaptée aux fonctions et à l'esthétique de la cuisine, pour une maison toujours coordonnée et efficiente, dans une relation de continuité esthétique et pratique qui garantira équilibre, harmonie et proportion dans chaque pièce de votre maison.



LEAD FREE



ZINC FREE



ROTATING





ARTICLE | ARTICOLO | ARTICLE

HR371



Dual Control Kitchen Mixer

Lavello monoforo con due leve

Évier de cuisine

| CODICE / COEFFICIENTE | CODE / COEFFICIENT | |
|-----------------------|--------------------|------|
| ● CC | HR371CC | 9,2 |
| ● PL | HR371PL | 14,7 |
| ● SS | HR371SS | 11,5 |
| ● II | HR371II | 13,8 |
| ● RS | HR371RS | 13,8 |
| ● OS | HR371OS | 14,7 |
| ● RR | HR371RR | 12,9 |

PACKAGING

L: 370 mm
 D: 270 mm
 H: 80 mm

2,6 kg

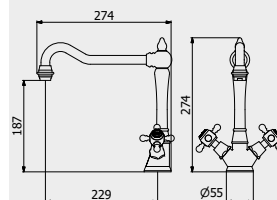

PORTATE | WATER FLOW | DÉBIT D'EAU

| 1 BAR | 2 BAR | 3 BAR |
|---------|--------|--------|
| 9,5 l/m | 11 l/m | 15 l/m |

ARTICLE | ARTICOLO | ARTICLE

HR373



Dual control Wall mounted kitchen mixer

Lavello a parete con due leve

Évier de cuisine encastré au mur

| CODICE / COEFFICIENTE | CODE / COEFFICIENT | |
|-----------------------|--------------------|------|
| ● CC | HR373CC | 7,4 |
| ● PL | HR373PL | 11,8 |
| ● SS | HR373SS | 9,3 |
| ● II | HR373II | 11,1 |
| ● RS | HR373RS | 11,1 |
| ● OS | HR373OS | 11,8 |
| ● RR | HR373RR | 10,4 |
| ● BB | HR373BB | 10,4 |

PACKAGING

L: 425 mm
 D: 188 mm
 H: 98 mm

1,8 kg

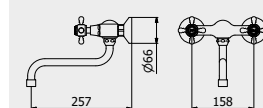

PORTATE | WATER FLOW | DÉBIT D'EAU

| 1 BAR | 2 BAR | 3 BAR |
|--------|--------|--------|
| 10 l/m | 15 l/m | 18 l/m |

ARTICLE | ARTICOLO | ARTICLE

HL371



Dual Control Kitchen Mixer

Lavello monoforo con due leve

Évier de cuisine

| CODICE / COEFFICIENTE | CODE / COEFFICIENT | CODE / COEFFICIENT | | |
|-----------------------|--------------------|--------------------|-----------|------|
| ● CC | HL371CC_1 | HL371CC_2 | HL371CC_3 | 9,2 |
| ● PL | HL371PL_1 | HL371PL_2 | HL371PL_3 | 14,7 |
| ● SS | HL371SS_1 | HL371SS_2 | HL371SS_3 | 11,5 |
| ● II | HL371II_1 | HL371II_2 | HL371II_3 | 13,8 |
| ● RS | HL371RS_1 | HL371RS_2 | HL371RS_3 | 13,8 |
| ● OS | HL371OS_1 | HL371OS_2 | HL371OS_3 | 14,7 |
| ● RR | HL371RR_1 | HL371RR_2 | HL371RR_3 | 12,9 |

PACKAGING

L: 370 mm D: 270 mm H: 80 mm

2,6 kg

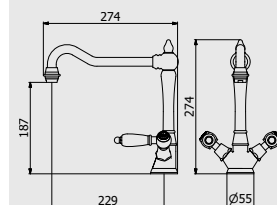

PORTATE | WATER FLOW | DÉBIT D'EAU

| 1 BAR | 2 BAR | 3 BAR |
|---------|--------|--------|
| 9,5 l/m | 11 l/m | 15 l/m |

ARTICLE | ARTICOLO | ARTICLE

HL373



Dual control Wall mounted kitchen mixer

Lavello a parete con due leve

Évier de cuisine encastré au mur

| CODICE / COEFFICIENTE | CODE / COEFFICIENT | CODE / COEFFICIENT | | |
|-----------------------|--------------------|--------------------|-----------|------|
| ● CC | HL373CC_1 | HL373CC_2 | HL373CC_3 | 7,4 |
| ● PL | HL373PL_1 | HL373PL_2 | HL373PL_3 | 11,8 |
| ● SS | HL373SS_1 | HL373SS_2 | HL373SS_3 | 9,3 |
| ● II | HL373II_1 | HL373II_2 | HL373II_3 | 11,1 |
| ● RS | HL373RS_1 | HL373RS_2 | HL373RS_3 | 11,1 |
| ● OS | HL373OS_1 | HL373OS_2 | HL373OS_3 | 11,8 |
| ● RR | HL373RR_1 | HL373RR_2 | HL373RR_3 | 10,4 |
| ● BB | HL373BB_1 | HL373BB_2 | HL373BB_3 | 10,4 |

PACKAGING

L: 425 mm D: 188 mm H: 98 mm

1,8 kg

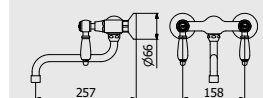

PORTATE | WATER FLOW | DÉBIT D'EAU

| 1 BAR | 2 BAR | 3 BAR |
|--------|--------|--------|
| 10 l/m | 15 l/m | 18 l/m |



ARTICLE | ARTICOLO | ARTICLE

WI415



Under-window sink mixer with reed pipe

Lavello sotto-finestra con canna a tubo

Évier de cuisine dessous fenêtre avec bec rabattable

| CODICE / COEFFICIENTE | CODE / COEFFICIENT | |
|-----------------------|--------------------|------|
| CC | WI415CC | 10,1 |
| SS | WI415SS | 12,6 |
| RR | WI415RR | 14,1 |
| BB | WI415BB | 14,1 |

PACKAGING

L: 455 mm
D: 310 mm
H: 75 mm

3,1 kg

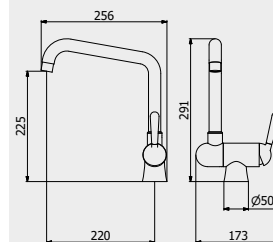

PORTATE | WATER FLOW | DÉBIT D'EAU

| 1 BAR | 2 BAR | 3 BAR |
|-------|---------|---------|
| 3 l/m | 4,4 l/m | 4,5 l/m |

ARTICLE | ARTICOLO | ARTICLE

WI416



Under-window sink mixer with cast spout

Lavello sotto-finestra con canna fusa

Évier de cuisine dessous fenêtre avec bec rabattable

| CODICE / COEFFICIENTE | CODE / COEFFICIENT | |
|-----------------------|--------------------|------|
| CC | WI416CC | 8,5 |
| SS | WI416SS | 10,6 |
| RR | WI416RR | 11,9 |
| BB | WI416BB | 11,9 |

PACKAGING

L: 580 mm
D: 370 mm
H: 75 mm

3,1 kg

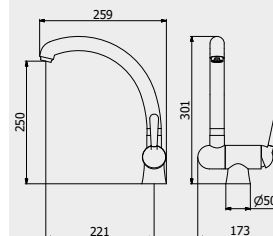

PORTATE | WATER FLOW | DÉBIT D'EAU

| 1 BAR | 2 BAR | 3 BAR |
|-------|---------|---------|
| 3 l/m | 4,4 l/m | 4,5 l/m |

ARTICLE | ARTICOLO | ARTICLE

WI417



Under-window sink mixer with cane classic

Lavello sotto-finestra con canna classico

Évier de cuisine dessous fenêtre avec bec rabattable

| CODICE / COEFFICIENTE | CODE / COEFFICIENT | |
|-----------------------|--------------------|------|
| CC | WI417CC | 10,6 |
| SS | WI417SS | 13,3 |
| RR | WI417RR | 14,8 |
| BB | WI417BB | 14,8 |

PACKAGING

L: 455 mm
D: 310 mm
H: 75 mm

3,3 kg

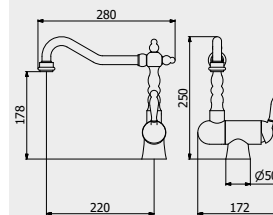

PORTATE | WATER FLOW | DÉBIT D'EAU

| 1 BAR | 2 BAR | 3 BAR |
|-------|---------|---------|
| 3 l/m | 4,4 l/m | 4,5 l/m |

ARTICLE | ARTICOLO | ARTICLE

AT370



Sink mixer

Lavello Monoforo Miscelatore

Évier de cuisine

**CODICE / COEFFICIENTE | CODICE /
COEFFICIENTE | CODE / COEFFICIENT**

| | | |
|------|---------|------|
| ● CC | AT370CC | 12,4 |
| ● SS | AT370SS | 15,5 |

PACKAGING

 L: 225 mm
D: 95 mm
H: 70 mm

3,9 kg

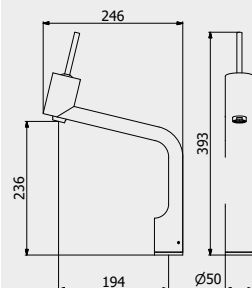

PORTATE | WATER FLOW | DÉBIT D'EAU

| | | |
|-------|---------|---------|
| 1 BAR | 2 BAR | 3 BAR |
| 3 l/m | 4,4 l/m | 4,5 l/m |

ARTICLE | ARTICOLO | ARTICLE

BI370



Sink mixer

Lavello Monoforo Miscelatore

Évier de cuisine

**CODICE / COEFFICIENTE | CODICE /
COEFFICIENTE | CODE / COEFFICIENT**

| | | |
|------|---------|------|
| ● CC | BI370CC | 10,8 |
| ● SS | BI370SS | 13,5 |
| ● BO | BI370BO | 13,0 |
| ● NP | BI370NP | 13,0 |
| ● CF | BI370CF | 16,2 |
| ● CS | BI370CS | 17,3 |
| ● II | BI370II | 16,2 |
| ● IS | BI370IS | 17,3 |
| ● RS | BI370RS | 16,2 |
| ● SR | BI370SR | 17,3 |
| ● OO | BI370OO | 16,2 |
| ● OS | BI370OS | 17,3 |

PACKAGING

 L: 425 mm
D: 188 mm
H: 98 mm

2,7 kg

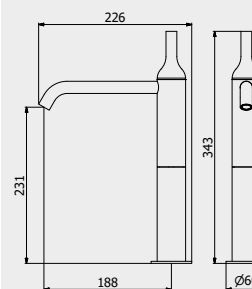

PORTATE | WATER FLOW | DÉBIT D'EAU

| | | |
|----------|-----------|----------|
| 1 BAR | 2 BAR | 3 BAR |
| 9,25 l/m | 13,35 l/m | 16,6 l/m |

ARTICLE | ARTICOLO | ARTICLE

HJ370



Single Lever kitchen mixer

Lavello Monoforo Miscelatore

Évier de cuisine

**CODICE / COEFFICIENTE | CODICE /
COEFFICIENTE | CODE / COEFFICIENT**

| | | |
|------|---------|------|
| ● CC | HJ370CC | 14,0 |
| ● SS | HJ370SS | 17,5 |
| ● NP | HJ370NP | 16,8 |

PACKAGING

 L: 455 mm
D: 310 mm
H: 75 mm

3,4 kg

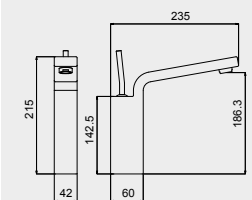

PORTATE | WATER FLOW | DÉBIT D'EAU

| | | |
|----------|--------|--------|
| 1 BAR | 2 BAR | 3 BAR |
| 21,5 l/m | 30 l/m | 38 l/m |

ARTICLE | ARTICOLO | ARTICLE

B1370



Single Lever kitchen mixer

Miscelatore lavello monoforo

Évier de cuisine

**CODICE / COEFFICIENTE | CODICE /
COEFFICIENTE | CODE / COEFFICIENT**

| | | |
|------|---------|------|
| ● CC | B1370CC | 14 |
| ● SS | B1370SS | 17,5 |
| ● ON | B1370ON | 14,0 |
| ● NP | B1370NP | 16,8 |
| ● CF | B1370CF | 21,0 |
| ● CS | B1370CS | 22,4 |
| ● II | B1370II | 21,0 |
| ● IS | B1370IS | 22,4 |
| ● RS | B1370RS | 21,0 |
| ● SR | B1370SR | 22,4 |
| ● OO | B1370OO | 21,0 |
| ● OS | B1370OS | 22,4 |

PACKAGING

 L: 400 mm
D: 250 mm
H: 140 mm

3,5 kg

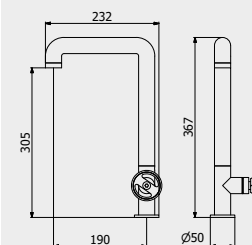

PORTATE | WATER FLOW | DÉBIT D'EAU

| | | |
|-------|---------|---------|
| 1 BAR | 2 BAR | 3 BAR |
| 3 l/m | 4,4 l/m | 4,5 l/m |

 -6 LEVA ROSSA | RED
LEVER | ROUGE LEVIER + 0,1

ARTICLE | ARTICOLO | ARTICLE

B2370



Single Lever kitchen mixer
Miscelatore lavello monoforo
Évier de cuisine

| CODE / COEFFICIENT | COEFFICIENT | CODICE / COEFFICIENTE | COEFFICIENT |
|---|-------------|-----------------------|-------------|
| CC | B2370CC | | 14 |
| SS | B2370SS | | 17,5 |
| ON | B2370ON | | 14,0 |
| NP | B2370NP | | 16,8 |
| CF | B2370CF | | 21,0 |
| CS | B2370CS | | 22,4 |
| II | B2370II | | 21,0 |
| IS | B2370IS | | 22,4 |
| RS | B2370RS | | 21,0 |
| SR | B2370SR | | 22,4 |
| OO | B2370OO | | 21,0 |
| OS | B2370OS | | 22,4 |
| 6 LEVA ROSSA RED LEVER LEVIER ROUGE + 0,1 | | | |

PACKAGING

L: 400 mm
D: 250 mm
H: 140 mm
3,5 kg

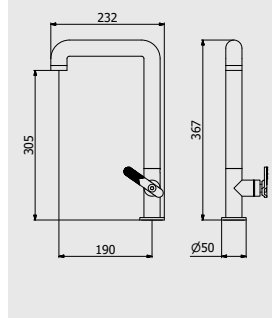

| PORTATE | WATER FLOW | DÉBIT D'EAU |
|---------|------------|-------------|
| 1 BAR | 2 BAR | 3 BAR |
| 3 l/m | 4,4 l/m | 4,5 l/m |

ARTICLE | ARTICOLO | ARTICLE

KS370



Single Lever kitchen mixer
Lavello Monoforo Miscelatore
Évier de cuisine

| CODE / COEFFICIENT | COEFFICIENT | CODICE / COEFFICIENTE | COEFFICIENT |
|--------------------|-------------|-----------------------|-------------|
| CC | KS370CC | | 9,9 |
| SS | KS370SS | | 12,4 |
| NP | KS370NP | | 11,9 |

PACKAGING

L: 455 mm
D: 310 mm
H: 75 mm
3,6 kg

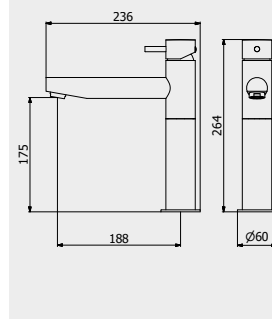

| PORTATE | WATER FLOW | DÉBIT D'EAU |
|---------|------------|-------------|
| 1 BAR | 2 BAR | 3 BAR |
| 9 l/m | 13 l/m | 16 l/m |

ARTICLE | ARTICOLO | ARTICLE

KS385



Side lever kitchen mixer
Miscelatore lavello monoforo con leva laterale
Évier de cuisine avec levier latéral

| CODE / COEFFICIENT | COEFFICIENT | CODICE / COEFFICIENTE | COEFFICIENT |
|--------------------|-------------|-----------------------|-------------|
| CC | KS385CC | | 7,4 |
| SS | KS385SS | | 9,3 |
| NP | KS385NP | | 8,9 |

PACKAGING

L: 370 mm
D: 270 mm
H: 80 mm
2,5 kg

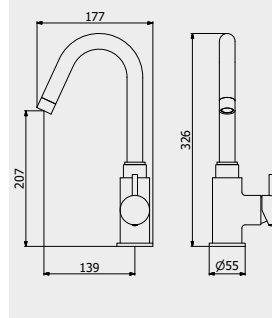

| PORTATE | WATER FLOW | DÉBIT D'EAU |
|---------|------------|-------------|
| 1 BAR | 2 BAR | 3 BAR |
| 9 l/m | 12,5 l/m | 15 l/m |

ARTICLE | ARTICOLO | ARTICLE

KU370



Single Lever kitchen mixer
Lavello Monoforo Miscelatore
Évier de cuisine

| CODE / COEFFICIENT | COEFFICIENT | CODICE / COEFFICIENTE | COEFFICIENT |
|--------------------|-------------|-----------------------|-------------|
| CC | KU370CC | | 9,9 |
| SS | KU370SS | | 12,4 |
| NP | KU370NP | | 11,9 |

PACKAGING

L: 455 mm
D: 310 mm
H: 75 mm
3,6 kg

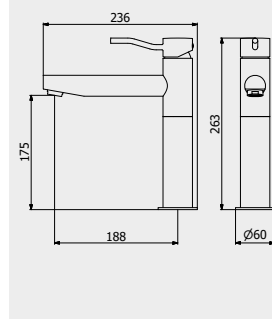

| PORTATE | WATER FLOW | DÉBIT D'EAU |
|---------|------------|-------------|
| 1 BAR | 2 BAR | 3 BAR |
| 3 l/m | 4,4 l/m | 4,5 l/m |

Kitchen

ARTICLE | ARTICOLO | ARTICLE

KU385



Side lever kitchen mixer

Miscelatore lavello monoforo con leva laterale

Évier de cuisine avec levier latéral

CODICE / COEFFICIENTE | CODICE /
COEFFICIENTE | CODE / COEFFICIENT

| | | |
|------|---------|-----|
| ● CC | KU385CC | 7,4 |
| ● SS | KU385SS | 9,3 |
| ● NP | KU385NP | 8,9 |

PACKAGING

L: 370 mm
 D: 270 mm
 H: 80 mm

2,5 kg

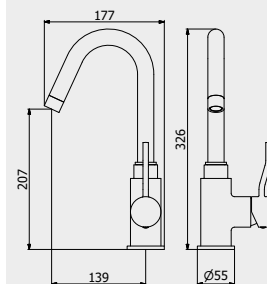

PORTATE | WATER FLOW | DÉBIT D'EAU

| | | |
|-------|----------|--------|
| 1 BAR | 2 BAR | 3 BAR |
| 9 l/m | 12,5 l/m | 15 l/m |

ARTICLE | ARTICOLO | ARTICLE

MT370



Single Lever kitchen mixer

Miscelatore lavello monoforo

Évier de cuisine

CODICE / COEFFICIENTE | CODICE /
COEFFICIENTE | CODE / COEFFICIENT

| | | |
|------|---------|------|
| ● CC | MT370CC | 9,6 |
| ● SS | MT370SS | 12,0 |
| ● ON | MT370ON | 9,6 |
| ● BO | MT370BO | 11,5 |
| ● NP | MT370NP | 11,5 |
| ● CF | MT370CF | 14,4 |
| ● CS | MT370CS | 15,4 |
| ● II | MT370II | 14,4 |
| ● IS | MT370IS | 15,4 |
| ● RS | MT370RS | 14,4 |
| ● SR | MT370SR | 15,4 |
| ● OO | MT370OO | 14,4 |
| ● OS | MT370OS | 15,4 |

PACKAGING

L: 455 mm
 D: 310 mm
 H: 75 mm

2,6 kg

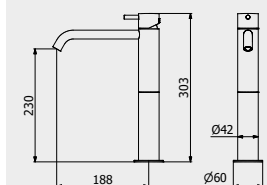

PORTATE | WATER FLOW | DÉBIT D'EAU

| | | |
|----------|----------|----------|
| 1 BAR | 2 BAR | 3 BAR |
| 6,35 l/m | 2,89 l/m | 10,9 l/m |

ARTICLE | ARTICOLO | ARTICLE

SB370



Sink mixer

Lavello Monoforo Miscelatore

Évier de cuisine

CODICE / COEFFICIENTE | CODE /
COEFFICIENTE | CODE / COEFFICIENT

| | | |
|------|---------|------|
| ● CC | SB370CC | 12,8 |
| ● SS | SB370SS | 16,0 |
| ● NP | SB370NP | 15,4 |
| ● OS | SB370OS | 20,5 |
| ● RS | SB370RS | 19,2 |
| ● ON | SB370ON | 12,8 |

PACKAGING

L: 400 mm
 D: 250 mm
 H: 140 mm

2,8 kg

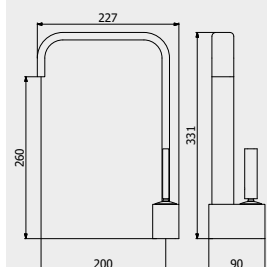

PORTATE | WATER FLOW | DÉBIT D'EAU

| | | |
|--------|--------|--------|
| 1 BAR | 2 BAR | 3 BAR |
| 10 l/m | 14 l/m | 17 l/m |

ARTICLE | ARTICOLO | ARTICLE

UN370



Sink mixer

Lavello Monoforo Miscelatore

Évier de cuisine

CODICE / COEFFICIENTE | CODE /
COEFFICIENTE | CODE / COEFFICIENT

| | | |
|------|---------|------|
| ● CC | UN370CC | 8,5 |
| ● II | UN370II | 12,8 |
| ● BB | UN370BB | 11,1 |
| ● RR | UN370RR | 11,1 |

PACKAGING

L: 225 mm
 D: 95 mm
 H: 70 mm

2,2 kg

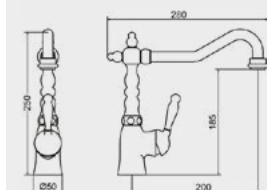

PORTATE | WATER FLOW | DÉBIT D'EAU

| | | |
|-------|---------|---------|
| 1 BAR | 2 BAR | 3 BAR |
| 3 l/m | 4,4 l/m | 4,5 l/m |

ARTICLE | ARTICOLO | ARTICLE

ID370



Single Lever kitchen mixer
Lavello Monoforo Miscelatore
Évier de cuisine

CODE / COEFFICIENT | CODICE / COEFFICIENTE | CODE / COEFFICIENT

BODY | CORPO | CORPS

LEVER | LEVA | LEVIER



+



| | | |
|------|----------|------|
| ● CC | ID370CC | 9,3 |
| ● SS | ID370SS | 14,0 |
| ● ON | ID3700N | 9,3 |
| ● NP | ID3700NP | 11,2 |
| ● CF | ID370CF | 14,0 |
| ● CS | ID370CS | 14,9 |
| ● II | ID370II | 14,0 |
| ● IS | ID370IS | 14,9 |
| ● RS | ID370RS | 14,0 |
| ● SR | ID370SR | 14,9 |
| ● OO | ID370OO | 14,0 |
| ● OS | ID370OS | 14,9 |

| | | |
|------|-----|-----|
| ● CC | _1 | 1,1 |
| ● SS | _14 | 1,7 |
| ● ON | _10 | 1,1 |
| ● NP | _13 | 1,4 |
| ● CF | _3 | 1,7 |
| ● CS | _4 | 1,8 |
| ● II | _8 | 1,7 |
| ● IS | _9 | 1,8 |
| ● RS | _7 | 1,7 |
| ● SR | _14 | 1,8 |
| ● OO | _5 | 1,7 |
| ● OS | _9 | 1,8 |

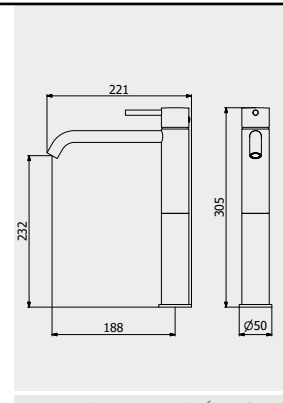

PORTATE | WATER FLOW | DÉBIT D'EAU

| | | |
|---------|---------|---------|
| 1 BAR | 2 BAR | 3 BAR |
| 5,5 l/m | 7,5 l/m | 9,1 l/m |

PACKAGING

L: 455 mm
D: 310 mm
H: 75 mm

2,7 kg

SPARE PARTS

LEGEND | LEGENDA | LÉGENDE

| | |
|--|---|
| A Aerator Basin Kit Kit Aeratore lavabo Kit Mousseur lavabo | H Headwork Vitone Tête céramique |
| F Flex Flessibile Tuyau | D Deviator Deviatore Déviateur |
| C Cartridge Cartuccia Cartouche | V Valve Valvola Clapet |

BOLD ROUND / LEVEL

| ARTICLE ARTICOLO ARTICLE | DESCRIPTION DESCRIZIONE DESCRIPTION | BY MODEL PER MODELLO PAR MODÈLE | COEFFICIENT COEFFICIENTE COEFFICIENT |
|---------------------------------|---|---------------------------------------|--|
| A AQ0015355 | Aerator basin kit M24x1 Kit aeratore M24x1 Kit mousseur M24x1 | 200 202 206 209 306 390 392 | 0,6 |
| F AQ0011013 | Flex G3/8" L450 Flessibile G3/8" L450 Tuyau G3/8" L450 | 200 202 209 306 390 392 | 1,1 |
| C AQ0015157 | Cartridge Ø25 Cartuccia Ø25 Cartouche Ø25 | 200 202 | 1,6 |
| H AQ0010529 AQ0010528 | Headwork G1/2" Vitone G1/2" Tête céramique G1/2" | 306 390 392 | 1,8 |
| C AQ0004095 | Cartridge Ø35 Cartuccia Ø35 Cartouche Ø35 | 206 | 1,0 |

MARMO / MARMO ELLE

| ARTICLE ARTICOLO ARTICLE | DESCRIPTION DESCRIZIONE DESCRIPTION | BY MODEL PER MODELLO PAR MODÈLE | COEFFICIENT COEFFICIENTE COEFFICIENT |
|---------------------------------|---|---------------------------------------|--|
| A AQ0015104 | Aerator basin kit M16,5x1 Kit aeratore M16,5x1 Kit mousseur M16,5x1 | 200 202 209 306 390 392 | 0,9 |
| F AQ0014772 | Flex G3/8" L400 Flessibile G3/8" L400 Tuyau G3/8" L400 | 200 202 | 1,3 |
| C AQ0014769 | Cartridge Ø25 Cartuccia Ø25 Cartouche Ø25 | 200 202 209 | 1,9 |
| H AQ0014917 AQ0014918 | Headwork G1/2" Vitone G1/2" Tête céramique G1/2" | 306 | 4 |
| H AQ0002135 AQ0003930 | Headwork G1/2" Vitone G1/2" Tête céramique G1/2" | 390 392 | 1,6 |



INDUSTRIA

| ARTICLE ARTICOLO ARTICLE | DESCRIPTION DESCRIZIONE DESCRIPTION | BY MODEL PER MODELLO PAR MODÈLE | COEFFICIENT COEFFICIENTE COEFFICIENT |
|---------------------------------|---|---------------------------------------|--|
| A AQ0014236 | Aerator basin kit M16,5x1 Kit aeratore M16,5x1 Kit mousseur M16,5x1 | 200 206 | 0,6 |
| F AQ0011013 | Flex G3/8" L400 Flessibile G3/8" L400 Tuyau G3/8" L400 | 200 | 1,1 |
| C AQ0013098 | Cartridge Ø25 Cartuccia Ø25 Cartouche Ø25 | 200 202 | 1,5 |
| A AQ0009836 | Aerator basin kit Honeycomb Kit aeratore Honeycomb Kit mousseur Honeycomb | 200 202 | 0,6 |
| F AQ0000932 | Flex G3/8" L400 Flessibile G3/8" L400 Tuyau G3/8" L400 | 202 | 1,1 |
| C AQ0004095 | Cartridge Ø35 Cartuccia Ø35 Cartouche Ø35 | 206 | 1,0 |
| H AQ0002135 AQ0003930 | Headwork G1/2" Vitone G1/2" Tête céramique G1/2" | 392 | 1,6 |
| A AQ0015903 | Aerator basin kit M16,5x1 Kit aeratore M16,5x1 Kit mousseur M16,5x1 | 392 | 0,8 |

TAAAC

| ARTICLE ARTICOLO ARTICLE | DESCRIPTION DESCRIZIONE DESCRIPTION | BY MODEL PER MODELLO PAR MODÈLE | COEFFICIENT COEFFICIENTE COEFFICIENT |
|---------------------------------|---|---------------------------------------|--|
| C AQ0015245 | Cartridge Ø35 Cartuccia Ø35 Cartouche Ø35 | 200 202 | 1,3 |
| A AQ0013390 | Aerator basin kit M24x1 Kit aeratore M24x1 Kit mousseur M24x1 | 200 202 | 0,7 |
| F AQ0000932 | Flex G3/8" L400 Flessibile G3/8" L400 Tuyau G3/8" L400 | 200 202 | 1,1 |
| C AQ0004095 | Cartridge Ø35 Cartuccia Ø35 Cartouche Ø35 | 206 | 1,0 |
| A AQ0015239 | Aerator basin kit M24x1 Kit aeratore M24x1 Kit mousseur M24x1 | 206 | 0,5 |
| H AQ0002135 AQ0003930 | Headwork G1/2" Vitone G1/2" Tête céramique G1/2" | 392 | 1,6 |
| F AQ0014772 | Flex G1/2" L400 Flessibile G1/2" L400 Tuyau G1/2" L400 | 392 | 1,3 |

K2 / K3

| ARTICLE ARTICOLO ARTICLE | DESCRIPTION DESCRIZIONE DESCRIPTION | BY MODEL PER MODELLO PAR MODÈLE | COEFFICIENT COEFFICIENTE COEFFICIENT |
|--------------------------------|---|---------------------------------------|--|
| C AQ0013479 | Cartridge Ø25 Cartuccia Ø25 Cartouche Ø25 | 200 202 | 1,6 |
| A AQ0013478 | Aerator basin kit M24x1 Kit aeratore M24x1 Kit mousseur M24x1 | 200 202 206 | 0,6 |
| F AQ0011013 | Flex G3/8" L450 Flessibile G3/8" L450 Tuyau G3/8" L450 | 200 202 | 1,1 |
| C AQ0014791 | Cartridge Ø35 Cartuccia Ø35 Cartouche Ø35 | 206 | 1,8 |

LOVEME

| ARTICLE ARTICOLO ARTICLE | DESCRIPTION DESCRIZIONE DESCRIPTION | BY MODEL PER MODELLO PAR MODÈLE | COEFFICIENT COEFFICIENTE COEFFICIENT |
|---------------------------------|--|---------------------------------------|--|
| C AQ0010039 | Cartridge Ø35 Cartuccia Ø35 Cartouche Ø35 | 200 202 | 1,2 |
| F AQ0013478 | Flex G1/2" L400 Flessibile G1/2" L400 Tuyau G1/2" L400 | 200 202 | 1,7 |
| C AQ0010069 | Cartridge Ø35 Cartuccia Ø35 Cartouche Ø35 | 206 | 1,2 |
| H AQ0010297 AQ0010298 | Headwork G1/2" Vitone G1/2" Tête céramique G1/2" | 390 392 | 1,8 |

BELMONDO

| ARTICLE ARTICOLO ARTICLE | DESCRIPTION DESCRIZIONE DESCRIPTION | BY MODEL PER MODELLO PAR MODÈLE | COEFFICIENT COEFFICIENTE COEFFICIENT |
|---------------------------------|---|---------------------------------------|--|
| C AQ0013098 | Cartridge Ø25 Cartuccia Ø25 Cartouche Ø25 | 200 | 1,5 |
| A AQ0012140 | Aerator basin kit M24x1 Kit aeratore M24x1 Kit mousseur M24x1 | 200 | 0,6 |
| F AQ0011013 | Flex G3/8" L450 Flessibile G3/8" L450 Tuyau G3/8" L450 | 200 | 1,1 |
| H AQ0010516 AQ0010515 | Headwork G1/2" Vitone G1/2" Tête céramique G1/2" | 205 | 1,6 |
| F AQ0000932 | Flex G3/8" L400 Flessibile G3/8" L400 Tuyau G3/8" L400 | 205 | 1,1 |
| H AQ0010852 AQ0010851 | Headwork G1/2" Vitone G1/2" Tête céramique G1/2" | 306 | 1,9 |
| H AQ0010528 AQ0010529 | Headwork G1/2" Vitone G1/2" Tête céramique G1/2" | 390 392 | 1,8 |
| A AQ0014147 | Aerator basin kit M16,5x1 Kit aeratore M16,5x1 Kit mousseur M16,5x1 | 390 392 | 1,8 |

WAVE

| ARTICLE ARTICOLO ARTICLE | DESCRIPTION DESCRIZIONE DESCRIPTION | BY MODEL PER MODELLO PAR MODÈLE | COEFFICIENT COEFFICIENTE COEFFICIENT |
|--------------------------------|---|---------------------------------------|--|
| C AQ0013479 | Cartridge Ø25 Cartuccia Ø25 Cartouche Ø25 | 200 202 | 1,6 |
| A AQ0012140 | Aerator basin kit M24x1 Kit aeratore M24x1 Kit mousseur M24x1 | 200 202 206 | 0,6 |
| F AQ0011013 | Flex G3/8" L450 Flessibile G3/8" L450 Tuyau G3/8" L450 | 200 | 1,1 |
| F AQ0012229 | Flex G3/8" L450 Flessibile G3/8" L450 Tuyau G3/8" L450 | 202 | 1,1 |
| C AQ0013189 | Cartridge Ø35 Cartuccia Ø35 Cartouche Ø35 | 206 | 1,3 |



TWITTER

| ARTICLE ARTICOLO ARTICLE | DESCRIPTION DESCRIZIONE DESCRIPTION | BY MODEL PER MODELLO PAR MODÈLE | COEFFICIENT COEFFICIENTE COEFFICIENT |
|--------------------------------|---|---------------------------------------|--|
| C AQ0013098 | Cartridge Ø25 Cartuccia Ø25 Cartouche Ø25 | 200 202 | 1,5 |
| A AQ0013746 | Aerator basin kit M18x1 Kit aeratore M18x1 Kit mousseur M18x1 | 200 202 206 | 0,6 |
| F AQ0011013 | Flex G3/8" L450 Flessibile G3/8" L450 Tuyau G3/8" L450 | 200 202 | 1,1 |
| C AQ0004095 | Cartridge Ø35 Cartuccia Ø35 Cartouche Ø35 | 206 | 1,0 |
| A AQ0013746 | Aerator basin kit M18,5x1 Kit aeratore M18,5x1 Kit mousseur M18,5x1 | 206 | 0,6 |

SUPERBOX

| ARTICLE ARTICOLO ARTICLE | DESCRIPTION DESCRIZIONE DESCRIPTION | BY MODEL PER MODELLO PAR MODÈLE | COEFFICIENT COEFFICIENTE COEFFICIENT |
|---------------------------------|--|---------------------------------------|--|
| C AQ0011012 | Cartridge Ø25 Cartuccia Ø25 Cartouche Ø25 | 200 202 | 2,0 |
| F AQ0000932 | Flex G3/8" L400 Flessibile G3/8" L400 Tuyau G3/8" L400 | 200 202 | 1,1 |
| H AQ0010172 | Headwork G3/4" Vitone G3/4" Tête céramique G3/4" | 306 | 1,8 |
| H AQ0010848 AQ0010849 | Headwork G1/2" Vitone G1/2" Tête céramique G1/2" | 390 392 | 1,6 |

MILANOTORINO

| ARTICLE ARTICOLO ARTICLE | DESCRIPTION DESCRIZIONE DESCRIPTION | BY MODEL PER MODELLO PAR MODÈLE | COEFFICIENT COEFFICIENTE COEFFICIENT |
|---------------------------------|---|---------------------------------------|--|
| A AQ0014236 | Aerator basin kit M16,5x1 Kit aeratore M16,5x1 Kit mousseur M16,5x1 | 200 206 | 0,6 |
| F AQ0011013 | Flex G3/8" L400 Flessibile G3/8" L400 Tuyau G3/8" L400 | 200 | 1,1 |
| C AQ0013098 | Cartridge Ø25 Cartuccia Ø25 Cartouche Ø25 | 200 202 | 1,5 |
| A AQ0009836 | Aerator basin kit Honeycomb Kit aeratore Honeycomb Kit mousseur Honeycomb | 202 | 0,6 |
| F AQ0000932 | Flex G3/8" L400 Flessibile G3/8" L400 Tuyau G3/8" L400 | 202 | 1,1 |
| C AQ0004095 | Cartridge Ø35 Cartuccia Ø35 Cartouche Ø35 | 206 | 1,0 |
| H AQ0002135 AQ0003930 | Headwork G1/2" Vitone G1/2" Tête céramique G1/2" | 392 | 1,6 |
| A AQ0015903 | Aerator basin kit M16,5x1 Kit aeratore M16,5x1 Kit mousseur M16,5x1 | 392 | 0,8 |
| A AQ0014236 | Aerator basin kit M16,5x1 Kit aeratore M16,5x1 Kit mousseur M16,5x1 | 206 | 0,6 |

BATLO'

| ARTICLE ARTICOLO ARTICLE | DESCRIPTION DESCRIZIONE DESCRIPTION | BY MODEL PER MODELLO PAR MODÈLE | COEFFICIENT COEFFICIENTE COEFFICIENT |
|---------------------------------|---|---------------------------------------|--|
| A AQ0009836 | Aerator basin kit Honeycomb Kit aeratore Honeycomb Kit mousseur Honeycomb | 200 202 392 | 0,6 |
| F AQ0011013 | Flex G3/8" L400 Flessibile G3/8" L400 Tuyau G3/8" L400 | 200 202 | 1,1 |
| C AQ0010963 | Cartridge Ø25 Cartuccia Ø25 Cartouche Ø25 | 200 202 | 2,0 |
| F AQ0000932 | Flex G3/8" L400 Flessibile G3/8" L400 Tuyau G3/8" L400 | 202 | 1,1 |
| C AQ0010964 | Cartridge Ø35 Cartuccia Ø35 Cartouche Ø35 | 206 | 1,2 |
| H AQ0010528 AQ0010529 | Headwork G1/2" Vitone G1/2" Tête céramique G1/2" | 392 | 1,8 |
| A AQ0014236 | Aerator basin kit M16,5x1 Kit aeratore M16,5x1 Kit mousseur M16,5x1 | 206 | 0,6 |

ONLYONE

| ARTICLE ARTICOLO ARTICLE | DESCRIPTION DESCRIZIONE DESCRIPTION | BY MODEL PER MODELLO PAR MODÈLE | COEFFICIENT COEFFICIENTE COEFFICIENT |
|---------------------------------|---|---------------------------------------|--|
| F AQ0000932 | Flex G3/8" L400 Flessibile G3/8" L400 Flex G3/8" L400 | 200 202 | 1,1 |
| C AQ0010513 | Cartridge Ø25 Cartuccia Ø25 Cartouche Ø25 | 200 202 206 | 3,6 |
| H AQ0002135 AQ0003930 | Headwork G1/2" Vitone G1/2" Tête céramique G1/2" | 392 | 1,6 |

RUBACUORI

| ARTICLE ARTICOLO ARTICLE | DESCRIPTION DESCRIZIONE DESCRIPTION | BY MODEL PER MODELLO PAR MODÈLE | COEFFICIENT COEFFICIENTE COEFFICIENT |
|--------------------------------|---|---------------------------------------|--|
| A AQ0014236 | Aerator basin kit M24x1 Kit aeratore M24x1 Kit mousseur M24x1 | 200 | 0,6 |
| F AQ0011013 | Flex G3/8" L400 Flessibile G3/8" L400 Flex G3/8" L400 | 200 202 | 1,1 |
| C AQ0013098 | Cartridge Ø25 Cartuccia Ø25 Cartouche Ø25 | 200 202 | 1,5 |
| A AQ0013390 | Aerator basin kit M24x1 Kit aeratore M24x1 Kit mousseur M24x1 | 202 | 0,7 |
| C AQ0004095 | Cartridge Ø35 Cartuccia Ø35 Cartouche Ø35 | 206 | 1,0 |
| A AQ0000020 | Aerator basin kit M24x1 Kit aeratore M24x1 Kit mousseur M24x1 | 206 | 0,5 |



HEYJOE

| ARTICLE ARTICOLO ARTICLE | DESCRIPTION DESCRIZIONE DESCRIPTION | BY MODEL PER MODELLO PAR MODÈLE | COEFFICIENT COEFFICIENTE COEFFICIENT |
|---------------------------------|---|---------------------------------------|--|
| A AQ0000020 | Aerator basin kit M24x1 Kit aeratore M24x1 Kit mousseur M24x1 | 200 202 206 392 | 0,5 |
| F AQ0000932 | Flex G3/8" L400 Flessibile G3/8" L400 Tuyau G3/8" L400 | 200 202 | 1,1 |
| C AQ0010039 | Cartridge Ø35 Cartuccia Ø35 Cartouche Ø35 | 200 202 | 1,2 |
| C AQ0004095 | Cartridge Ø35 Cartuccia Ø35 Cartouche Ø35 | 206 | 1,0 |
| H AQ0002135 AQ0003930 | Headwork G1/2" Vitone G1/2" Tête céramique G1/2" | 392 | 1,6 |

BIRKIN

| ARTICLE ARTICOLO ARTICLE | DESCRIPTION DESCRIZIONE DESCRIPTION | BY MODEL PER MODELLO PAR MODÈLE | COEFFICIENT COEFFICIENTE COEFFICIENT |
|---------------------------------|---|---------------------------------------|--|
| H AQ0002135 AQ0003930 | Headwork G1/2" Vitone G1/2" Tête céramique G1/2" | 200 390 | 1,6 |
| A AQ0000020 | Aerator basin kit M24x1 Kit aeratore M24x1 Kit mousseur M24x1 | 200 390 | 0,5 |
| F AQ0000932 | Flex G3/8" L400 Flessibile G3/8" L400 Tuyau G3/8" L400 | 200 220 | 1,1 |
| H AQ0010852 AQ0010851 | Headwork G1/2" Vitone G1/2" Tête céramique G1/2" | 306 | 1,9 |
| A AQ0014147 | Aerator basin kit M16,5x1 Kit aeratore M16,5x1 Kit mousseur M16,5x1 | 306 | 0,8 |

HERMES

| ARTICLE ARTICOLO ARTICLE | DESCRIPTION DESCRIZIONE DESCRIPTION | BY MODEL PER MODELLO PAR MODÈLE | COEFFICIENT COEFFICIENTE COEFFICIENT |
|---------------------------------|---|---------------------------------------|--|
| H AQ0002135 AQ0003930 | Headwork G1/2" Vitone G1/2" Tête céramique G1/2" | 205 390 392 | 1,6 |
| A AQ0000020 | Aerator basin kit M24x1 Kit aeratore M24x1 Kit mousseur M24x1 | 205 390 392 | 0,5 |
| F AQ0000932 | Flex G3/8" L400 Flessibile G3/8" L400 Tuyau G3/8" L400 | 205 | 1,1 |
| H AQ0009356 AQ0009357 | Headwork G1/2" Vitone G1/2" Tête céramique G1/2" | 306 | 1,9 |
| A AQ0014236 | Aerator basin kit M16,5x1 Kit aeratore M16,5x1 Kit mousseur M16,5x1 | 306 | 0,6 |

KUSASI / KUSASI SHORT

| ARTICLE ARTICOLO ARTICLE | DESCRIPTION DESCRIZIONE DESCRIPTION | BY MODEL PER MODELLO PAR MODÈLE | COEFFICIENT COEFFICIENTE COEFFICIENT |
|---------------------------------|---|---------------------------------------|--|
| C AQ0004075 | Cartridge Ø35 Cartuccia Ø35 Cartouche Ø35 | 200 202 | 1,0 |
| A AQ0000020 | Aerator basin kit M24x1 Kit aeratore M24x1 Kit mousseur M24x1 | 200 202 390 392 | 0,5 |
| F AQ0000932 | Flex G3/8" L400 Flessibile G3/8" L400 Tuyau G3/8" L400 | 205 | 1,1 |
| F AQ0006235 | Flex G3/8" L600 Flessibile G3/8" L600 Tuyau G3/8" L600 | 202 | 1,2 |
| C AQ0004095 | Cartridge Ø35 Cartuccia Ø35 Cartouche Ø35 | 206 | 1,0 |
| A AQ0014236 | Aerator basin kit M16,5x1 Kit aeratore M16,5x1 Kit mousseur M16,5x1 | 206 | 0,6 |
| H AQ0002135 AQ0003930 | Headwork G1/2" Vitone G1/2" Tête céramique G1/2" | 390 392 | 1,6 |

AQUA

| ARTICLE ARTICOLO ARTICLE | DESCRIPTION DESCRIZIONE DESCRIPTION | BY MODEL PER MODELLO PAR MODÈLE | COEFFICIENT COEFFICIENTE COEFFICIENT |
|--------------------------------|--|---------------------------------------|--|
| C AQ0011042 | Thermostatic cartridge Cartuccia termostatica Cartouche Thermostatique | All Tutti Tous | 3,1 |
| V CP12312 | Not return valve Valvola di non ritorno Clapet anti-retour | All Tutti Tous | 1,1 |
| V CP12311 | Not return valve Valvola di non ritorno Clapet anti-retour | All Tutti Tous | 1,1 |
| H AQ0014336 | Headwork G1/2" Vitone G1/2" Tête céramique G1/2" | All Tutti Tous | 1,1 |

BUILT-IN EXTENSIONS

| ARTICLE ARTICOLO ARTICLE | DESCRIPTION DESCRIZIONE DESCRIPTION | BY MODEL PER MODELLO PAR MODÈLE | COEFFICIENT COEFFICIENTE COEFFICIENT |
|--------------------------------|--|---------------------------------------|--|
| KSP001CCPR_1 | Built-in extensions kit Kit prolunga incasso Kit d'extension pour encastré | 206 (Y) | 3,3 |
| KRC048CCXN_1 | Built-in extensions kit Kit prolunga incasso Kit d'extension pour encastré | 300(Y) | 3,1 |
| KSP002CCPR_1 | Built-in extensions kit Kit prolunga incasso Kit d'extension pour encastré | 310 (Y) | 4,2 |
| KSP003CCPR_1 | Built-in extensions kit Kit prolunga incasso Kit d'extension pour encastré | 312 (Y) | 4,2 |
| KSP004CCPR_1 | Built-in extensions kit Kit prolunga incasso Kit d'extension pour encastré | 313 (Y) | 4,5 |
| KSP005CCPR_1 | Built-in extensions kit Kit prolunga incasso Kit d'extension pour encastré | 314 (Y) | 4,5 |



| | | | |
|----------------------|--|------------------|-----|
| KSP006CCPR_1 | Built-in extensions kit Kit prolunga incasso Kit d'extension pour encastré | 206 BATLÓ | 3,2 |
| KRC789CCXN_1 | Built-in extensions kit Kit prolunga incasso Kit d'extension pour encastré | 300 BATLÓ | 2,9 |
| KSP007CCPR_1 | Built-in extensions kit Kit prolunga incasso CvKit d'extension pour encastré | 310 BATLÓ | 4,1 |
| KSP008CCPR_1 | Built-in extensions kit Kit prolunga incasso Kit d'extension pour encastré | 312 BATLÓ | 4,0 |
| KSP009CCPR_1 | Built-in extensions kit Kit prolunga incasso Kit d'extension pour encastré | 313 BATLÓ | 4,3 |
| KSP010CCPR_1 | Built-in extensions kit Kit prolunga incasso Kit d'extension pour encastré | 314 BATLÓ | 4,3 |
| KSP011CCPR_1 | Built-in extensions kit Kit prolunga incasso Kit d'extension pour encastré | 206 WAVE / BOLD | 3,2 |
| KRC783CCXN_1 | Built-in extensions kit Kit prolunga incasso Kit d'extension pour encastré | 300 WAVE / BATLÓ | 2,9 |
| KSP012CCPR_1 | Built-in extensions kit Kit prolunga incasso Kit d'extension pour encastré | 310 WAVE / BOLD | 4,2 |
| KSP013CCPR_1 | Built-in extensions kit Kit prolunga incasso Kit d'extension pour encastré | 312 WAVE / BOLD | 4,1 |
| KSP014CCPR_1 | Built-in extensions kit Kit prolunga incasso Kit d'extension pour encastré | 313 WAVE / BOLD | 4,3 |
| KSP015CCPR_1 | Built-in extensions kit Kit prolunga incasso Kit d'extension pour encastré | 314 WAVE / BOLD | 4,3 |
| KSP016CCPR_1 | Built-in extensions kit Kit prolunga incasso Kit d'extension pour encastré | 206 LOVEME | 3,3 |
| KRC1089CCXN_1 | Built-in extensions kit Kit prolunga incasso Kit d'extension pour encastré | 300 LOVEME | 2,9 |
| KSP017CCPR_1 | Built-in extensions kit Kit prolunga incasso Kit d'extension pour encastré | 310 LOVEME | 4,2 |
| KSP018CCPR_1 | Built-in extensions kit Kit prolunga incasso Kit d'extension pour encastré | 312 LOVEME | 4,2 |
| KSP019CCPR_1 | Built-in extensions kit Kit prolunga incasso Kit d'extension pour encastré | 313 LOVEME | 4,5 |
| KSP020CCPR_1 | Built-in extensions kit Kit prolunga incasso Kit d'extension pour encastré | 314 LOVEME | 4,5 |
| KRC697CCXN_1 | Built-in extensions kit Kit prolunga incasso Kit d'extension pour encastré | 300 BELMONDO | 3,1 |
| KRC697CCXN_1 | Built-in extensions kit Kit prolunga incasso Kit d'extension pour encastré | 300 BELMONDO | 3,1 |
| KSP021CCPR_1 | Built-in extensions kit Kit prolunga incasso Kit d'extension pour encastré | 310 BELMONDO | 4,2 |
| KSP022CCPR_1 | Built-in extensions kit Kit prolunga incasso Kit d'extension pour encastré | 312 BELMONDO | 4,2 |
| KSP023CCPR_1 | Built-in extensions kit Kit prolunga incasso Kit d'extension pour encastré | 313 BELMONDO | 4,5 |
| KSP024CCPR_1 | Built-in extensions kit Kit prolunga incasso Kit d'extension pour encastré | 314 BELMONDO | 4,4 |



SF

**SURFACE
FINITURE
FINITIONS**

We are all finishes company.

Siamo l'azienda per tutte le finiture.
Nous sommes l'entreprise de toute finition.

Every human being is a range of perceptions, unrepeatably in its originality. IB Rubinetti allows you to decorate your bathroom choosing from a selection of sixteen finishes, directly attended by our chrome plating department, in order to mirror your incomparable personality in every detail.

Ogni essere umano è un ventaglio inedito di sensazioni, irripetibile nella sua originalità. IB Rubinetti permette di ornare il tuo bagno scegliendo tra una gamma di sedici finiture, direttamente curate dal nostro reparto di cromatura, per riflettere in ogni dettaglio la tua ineguagliabile personalità.

Chaque être humain est un éventail de perceptions, unique dans son originalité. IB Rubinetti vous permet de décorer votre salle de bain en choisissant parmi une gamme de seize finitions, directement gérée par notre département de chromage, afin de retrouver dans les moindres détails votre incomparable personnalité.

All finishes are made by IB with the best technology and know-how to guarantee your peace of mind.

Tutte le finiture sono realizzate da IB con la migliore tecnologia per garantire la massima qualità.

Toutes ces finitions sont fabriquées par IB avec la meilleure technologie et savoir-faire pour garantir votre tranquillité d'esprit.



LEAD FREE



ZINC FREE

From the faucet to the flush plate, one finishing, your favourite.

Dal rubinetto alla placca del WC in un'unica finitura, la tua preferita.

Du robinet à la plaque de commande WC, tout en une seule finition, votre favorite.

FAUCET FOR WASHBASIN / BIDET | RUBINETTO PER LAVABO / BIDET | ROBINET POUR LAVABO / BIDET



SHOWER CONTROL | CONTROLLO DOCCIA | COMMANDE DE DOUCHE



SHOWER HEAD | SOFFIONI DOCCIA | TÊTE DE DOUCHE



ACCESSORIES | ACCESSORI | ACCESSOIRES



BATH FILLER | BORDO VASCA | BAIN



















SHUT-OFF AND FLUSH PLATE | INDROSCOPINO E PLACCA SCARICO | DOUCHETTE BIDET ET PLAQUE DE DÉCLENCHEMENT WC



| | | |
|----|--|---|
| CC | | CHROME CHROMO CHROME |
| PL | | PLATINUM PLATINO PLATINE |
| SS | | BRUSHED NICKEL NICKEL SPAZZOLATO NICKEL BROSSÉ |
| ON | | NATURAL BRASS OTTONE NATURALE LAITON NATUREL |
| BO | | MATT WHITE BIANCO OPACO BLANC MAT |
| NP | | MATT BLACK NERO OPACO NOIR MAT |
| CF | | BLACK CHROME BLACK CHROME BLACK CHROME |
| CS | | BRUSHED BLACK CHROME BLACK CHROME SPAZZOLATO BLACK CHROME BROSSÉ |
| II | | PALE GOLD 18K ORO INGLESE 18K OR PALE 18K |
| IS | | BRUSHED PALE GOLD 18K ORO INGLESE SPAZZOLATO 18K OR PALE BROSSÉ 18K |
| RS | | ROSE GOLD 18K ORO ROSA 18K OR ROSE 18K |
| SR | | BRUSHED ROSE GOLD 18K ORO ROSA SPAZZOLATO 18K OR ROSE BROSSÉ 18K |
| OO | | GOLD 22K ORO 22K OR 22K |
| OS | | BRUSHED GOLD 22K ORO SPAZZOLATO 22K OR BROSSÉ 22K |
| RR | | ANTIQUÉ COPPER RAME ANTICO CUIVRE ANTIQUE |
| BB | | ANTIQUÉ BRONZE BRONZO ANTICO BRONZE ANTIQUE |

ICONS INDEX

| | | |
|----|---|---|
| CC |  | CHROME CHROMO CHROME |
| PL |  | PLATINUM PLATINO PLATINE |
| SS |  | BRUSHED NICKEL NICKEL SPAZZOLATO NICKEL BROSSÉ |
| ON |  | NATURAL BRASS OTTONE NATURALE LAITON NATUREL |
| BO |  | MATT WHITE BIANCO OPACO BLANC MAT |
| NP |  | MATT BLACK NERO OPACO NOIR MAT |
| CF |  | BLACK CHROME BLACK CHROME BLACK CHROME |
| CS |  | BRUSHED BLACK CHROME BLACK CHROME SPAZZOLATO BLACK CHROME BROSSÉ |
| II |  | PALE GOLD 18K ORO INGLESE 18K OR PALE 18K |
| IS |  | BRUSHED PALE GOLD 18K ORO INGLESE SPAZZOLATO 18k OR PALE BROSSÉ 18k |
| RS |  | ROSE GOLD 18K ORO ROSA 18K OR ROSE 18K |
| SR |  | BRUSHED ROSE GOLD 18K ORO ROSA SPAZZOLATO 18K OR ROSE BROSSÉ 18K |
| OO |  | GOLD 22K ORO 22K OR 22K |
| OS |  | BRUSHED GOLD 22K ORO SPAZZOLATO 22K OR BROSSÉ 22K |
| RR |  | ANTIQUE COPPER RAME ANTICO CUIVRE ANTIQUE |
| BB |  | ANTIQUE BRONZE BRONZO ANTICO BRONZE ANTIQUE |

FUNCTIONS | FUNZIONI | FONCTIONS



Thermostatic control
Comando termostatico
Régulation thermostatique



Electronic control
Controllo elettronico
Contrôle électronique



Free intensity adjustment
Regolazione intensità indipendente
Réglage indépendant de l'intensité



Rotating spout
Bocca rotante
Bec rotatif



Function control
Controllo delle funzioni
Contrôle des fonctions



RGB LED light
Luce RGB LED
Lumière LED RGB

MATERIALS | MATERIALI | MATÉRIEL



Lead free solid brass
Ottone senza piombo
Laiton sans plomb



Produced in abs
Prodotto in abs
Produit en abs



Zinc free solid brass
Ottone senza zinco
Zinc sans plomb



Outdoor resistant
Resistente all'esterno
Résistant à l'extérieur

WATER JET | GETTI D'ACQUA | JET D'EAU



Rain jet
Getto pioggia
Jet de pluie



Concentrated rain jet
Getto pioggia concentrato
Jet de pluie concentré



Nebulization
Nebulizzazione
Pulvérisation



Aerated jet
Getto areato
Jet aéré



Waterfall
Cascata
Cascade



Double waterfall
Cascata doppia
Double cascade



Hand shower
Doccino
Douchette



Bodyjet
Bodyjet
Bodyjet



CODE AND TABLE INSTRUCTION

TALKING CODE | CODICE PARLANTE | CODE DE PAROLE

ID 200 CC _1

COLLECTION | COLLEZIONE | COLLECTION
 ARTICLE | ARTICOLO | ARTICLE
 FINISHES | FINITURA | FINITIONS
 DETAILS FINISHES | FINITURA DETTAGLI | FINITIONS DÉTAILS

TALKING CODE | CODICE PARLANTE | CODE DE PAROLE

ARTICLE | ARTICOLO | ARTICLE
B2206 (Pb)

Wall mounted washbasin mixer complete with drain
 Miscelatore lavabo due fori a parete completo di scarico automatico
 Mitigeur lavabo mural complet avec bonde automatique

| CODE / COEFFICIENT CODICE / COEFFICIENTE | COEFFICIENTE / COEFFICIENT |
|--|----------------------------|
| E2206CC | 18,6 |
| IS E2206CS | 15,9 |
| ON E2206GN | 12,6 |
| NP E2206NP | 15,1 |
| CF E2206CF | 18,9 |
| CS E2206CS | 20,2 |
| II E2206II | 18,9 |
| IS E2206IS | 20,2 |
| RS E2206RS | 18,9 |
| SR E2206SR | 20,2 |
| OD E2206OO | 18,9 |
| OS E2206OS | 20,2 |

PACKAGING
 L: 265 mm
 D: 260 mm
 H: 70 mm
 1,755 kg

PORTATE | WATER FLOW | DÉBIT D'EAU
 1 BAR 3,3 l/m
 2 BAR 4,4 l/m
 3 BAR 4,5 l/m

! Built-in body to be purchased separately
 Corpo incasso da acquistare separatamente
 Corps intégré à acheter séparément

CODICE | CODE | CODE
INC206CCXN_19
 COEFFICIENT | COEFFICIENTE | COEFFICIENT

- | | |
|--|---|
| A Article Articolo Article | F Coefficient Coefficiente Coefficient |
| B Product image Immagine prodotto Image du produit | G Packaging dimension and weight Dimensione e peso dell'imballaggio Dimensions et poids de l'emballage |
| C Description Descrizione Description | H Water flow Portate Débit d'eau |
| D Finishes reference Riferimento finitura Référence de finition | I Product dimensions Diemnsioni prodotto Dimension du produit |
| E Final product code Codice prodotto finito Code du produit final | L Any built-in parts Eventuali parti incasso Toutes les pièces encastrées |

GENERAL TERMS AND CONDITIONS OF SALE

General

IB Rubinetterie Spa shall assume this manufacturer's guarantee towards consumers of IB Rubinetterie Spa products in addition to the legal guarantee to which the consumer is entitled in relation to the seller. It shall apply without prejudice to mandatory liability regulations, such as those in accordance with the Product Liability Act, in cases of wilful intent and gross negligence, or resulting from loss of life, physical injury or damage to health by IB Rubinetterie Spa or its agents.

The term "consumer" in this manufacturer's guarantee shall refer to any natural person who owns the product and has not purchased it for the purpose of resale to or installation for a third party within the scope of its commercial or self-employed professional activities. The term "primary customer" shall mean the consumer who has directly purchased the product from IB Rubinetterie Spa or a dealer or other natural or legal person who resells or installs the product within the scope of its commercial or self-employed professional activities.

Guarantee protection

Valid for IB Rubinetterie Spa products purchased by primary customers on or after 01/01/2010 (purchase receipt):

IB Rubinetterie Spa guarantees consumers that its products are free from material, manufacturing and design faults. The latest science and technology at the time of manufacture is decisive in this regard. The defect giving rise to the damage must already have been present in the product at this time. Claims for the reimbursement of consequential damage or on the grounds of product liability shall only be valid in accordance with mandatory legal regulations.

This guarantee shall be valid for five years from the purchase date by the primary customer, and for a maximum of six years from the date of manufacture. The guarantee period shall not be extended due to the provision of services within the scope of this guarantee, especially not in the event of servicing or replacement. In such cases, the guarantee period shall also not start anew.

Written notification of defects

The consumer shall be entitled to assert the rights from this guarantee by providing IB Rubinetterie Spa or the dealer from whom the primary customer purchased the product with a written notification of defect within the guarantee period. The consumer must also provide notification of the defect within two months of its detection or the time at which its detection must have been possible. The consumer shall be obliged to prove that the guarantee has not expired (for example, by presenting the primary customer's purchase receipt). IB Rubinetterie Spa shall also be entitled to determine the start of the guarantee period on the basis of the data of manufacture.

Services in the event of a guarantee claim

IB Rubinetterie Spa shall be entitled to repair or replace the product, or to reimburse the consumer the purchase price.

Usually, the consumer has the faulty product repaired by a specialist on site with the prior agreement of IB Rubinetterie Spa. In such an event, the guarantee shall cover the free delivery of the necessary spare parts. If IB Rubinetterie Spa issues a written decision to conduct the maintenance itself, IB Rubinetterie Spa shall bear any costs that arise for spare parts, installation and labour, as well as any expenses incurred through the transportation or dispatch of the product. The consumer must provide access to the product.

In the event of a replacement, the old product shall be replaced by a new product of the same kind, value and type. If the product in question is no longer manufactured at the time at which the defect is reported, IB Rubinetterie Spa shall be entitled to

supply a similar product. Transport or dispatch to and from IB Rubinetterie Spa or to and from the dealer, any de-installation and re-installation of the product or any other special measures can only be carried out with the prior agreement of IB Rubinetterie Spa. If IB Rubinetterie Spa agrees to the intended measure, IB Rubinetterie Spa shall bear the costs arising from the measure being conducted. Unless otherwise agreed, the consumer shall undertake to collect the new product from the nearest IB Rubinetterie Spa dealer.

If IB Rubinetterie Spa chooses to reimburse the purchase price and confirms this in writing, the consumer shall return the product and IB Rubinetterie Spa shall reimburse the purchase price paid.

Conditions and exclusions

This guarantee shall only be valid if installation and maintenance have been duly conducted in accordance with the operating instructions and generally accepted engineering practices (e.g. by a master craftsman or authorised specialist), the operating instructions have been complied with and the IB Rubinetterie Spa products have been used in line with the technical and maintenance instructions provided by IB Rubinetterie Spa.

This shall include but not be limited to the inlet water pipes being duly flushed, especially prior to the product's installation or following construction measures in accordance with the valid standards, installation work complying with the appended diagrams and checks being conducted on the compliance of the working pressure in the water mains with technical specifications.

Installation, usage and maintenance instructions are provided with all products and can be found on www.ibrubinetterie.it

The guarantee shall not cover:

- Wear to wear and tear parts such as seals;
- Breakage of breakable components such as glass or bulbs;
- The exhaustion of consumable materials such as batteries, filters or aerators;
- Slight deviations of the IB Rubinetterie Spa products from the target quality that do not affect the usability of the product;
- Cleaning, water jets, in particular hot water jets, lime-scale deposits, operating and handling errors, damage caused by aggressive environmental influences, chemicals or detergents;
- Product defects caused by the installation, transportation or test operation of the purchased item;
- Damage caused by the faulty IB Rubinetterie Spa product;
- Display products and similar.
- The guarantee shall not be valid in the event of:
 - Non-compliance with the installation, maintenance and usage instructions appended or provided at www.ibrubinetterie.it;
 - Installation, maintenance, repair or servicing by non-qualified persons;
 - Product damage caused by the seller, plumber or third persons;
 - Damage that can be attributed to normal wear or intentional damage – in the event of negligent damage, contributory negligence shall be offset on agreement;
 - Improper installation or commissioning;
 - Insufficient or improper maintenance;
 - Products that have not been or are not used in line with their



intended purpose;

- Damage caused by force majeure or natural disasters, especially but not limited to floods, fires or frost damage.

Non-applicability of the guarantee

If a product defect is not covered by this guarantee, any costs that arise from the dispatch and transportation of the product shall be borne by the consumer. The consumer must also bear any costs, including labour costs, arising from the inspection of the product, as well as the costs of de-installing and re-installing the product.

If, having been informed of the non-applicability of the guarantee and the potential costs that could arise through the servicing activities, the consumer wishes the servicing activities to be conducted, it must also bear the costs of the spare parts and labour.

If the product defect was not present upon delivery, IB Rubinetterie Spa shall decide on a case-by-case basis whether said defect can be rectified through goodwill. In such cases, the consumer shall not have any legal right to the rectification of the defect.

Legal rights

In addition to the rights from the guarantee, the consumer shall also be entitled to statutory rights. These sometimes lesser rights for the consumer shall not be restricted by the guarantee. The guarantee shall also not affect the rights of the primary customer and, where applicable, the consumer in relation to the seller from whom the primary customer procured the product.

Place of fulfilment, place of jurisdiction and applicable laws

This guarantee shall be subject to Italian law under the exclusion of the UN Convention on Contracts for the International Sale of Goods (CISG) of 11 April 1980. The place of fulfilment for the obligations under this guarantee shall be Brescia, Italy. Where permissible, the place of jurisdiction shall be Brescia, Italy.



IB RUBINETTI CLEANING RECOMMENDATION

Today, modern sanitary and kitchen tapware, showers, accessories, washbasins, tubs and radiators consist of very different materials to comply with the needs of the market with regard to design and functionality. To avoid damage and claims, it is necessary to consider certain criteria when cleaning.

With regard to cleaning IB RUBINETTI products, the following points must be observed:

- Only use cleaning material which is explicitly provided for this type of application.
- Never use cleaning materials, which contain hydrochloric acid, formic acid, chlorine bleaching lye or acetic acid, as they cause considerable damage.
- Phosphorus acidic cleaners are only applicable under certain conditions.
- Mixing different cleaning agents is generally not permitted.
- Never use cleaning materials or appliances with an abrasive effect, such as unsuitable cleaning powders, sponge pads or micro fibre cloths.
- The instructions of the cleaning agent manufacturers have to be followed closely.
- Cleaning has to be carried out with a specified dosage of cleaning detergent, for a suitable limited time, object-related and adapted to the needs.
- Limescale has to be removed by regularly cleaning.
- When using spray cleaners, spray the cleaning solution onto a soft cloth or sponge, never directly onto the IB RUBINETTI products, as the atomised spray could enter openings and gaps in the product and cause damage.
- After cleaning, rinse thoroughly with clean water to remove any cleaner residue.
- The use of steam cleaners is not permitted. The high temperatures can damage the products.

Important

Residues of toiletries such as liquid soaps, shampoos and shower gels, hair dyes, perfumes, aftershave and nail varnish can also cause damage. Here too: Carefully rinse with water after use to remove residues. Likewise, do not store any cleaning agents or chemicals under the products, for example in a vanity unit, as the vapours may damage the products.

Components with damaged surfaces must be exchanged otherwise there could be a risk of injury. Damage caused by improper treatment is not covered by our guarantee.

CONDIZIONI GENERALI DI VENDITA

Generale

IB Rubinetterie Spa assumerà la garanzia del produttore nei confronti dei consumatori dei prodotti IB Rubinetterie Spa oltre alla garanzia legale a cui il consumatore ha diritto in relazione al venditore. Si applica senza pregiudizio delle norme di responsabilità obbligatoria, come quelle in conformità con la legge sulla responsabilità del prodotto, in caso di dolo intenzionale e colpa grave, o derivanti dalla perdita di vite umane, lesioni fisiche o danni alla salute da parte di IB Rubinetterie Spa o dei suoi agenti. .

Il termine "consumatore" nella presente garanzia del produttore si riferisce a qualsiasi persona fisica proprietaria del prodotto e che non l'abbia acquistata a scopo di rivendita o installazione per conto di terzi nell'ambito delle sue attività professionali commerciali o indipendenti. Con il termine "cliente principale" si intende il consumatore che ha acquistato direttamente il prodotto da IB Rubinetterie Spa o un rivenditore o altra persona fisica o giuridica che rivende o installa il prodotto nell'ambito delle sue attività professionali commerciali o indipendenti.

Garanzia di protezione

Valido per i prodotti IB Rubinetterie Spa acquistati dai clienti primari a partire dall'01 / 01/2010 (ricevuta di acquisto):

IB Rubinetterie Spa garantisce ai consumatori che i suoi prodotti sono privi di materiali, produzione e difetti di progettazione. L'ultima scienza e tecnologia al momento della produzione è decisiva a questo proposito. Il difetto all'origine del danno deve già essere stato presente nel prodotto in questo momento. Reclami per il rimborso di danni conseguenti o sulla base della responsabilità del prodotto è valida solo in conformità con le norme di legge obbligatorie.

Questa garanzia sarà valida per cinque anni dalla data di acquisto da parte del cliente principale e per un massimo di sei anni dalla data di produzione. Il periodo di garanzia non può essere esteso a causa della fornitura di

servizi nell'ambito di questa garanzia, in particolare non in caso di assistenza o sostituzione.

In tali casi, anche il periodo di garanzia non deve iniziare di nuovo.

Condizioni ed esclusioni

Questa garanzia è valida solo se l'installazione e la manutenzione sono state eseguite correttamente in conformità con le istruzioni operative e le pratiche ingegneristiche generalmente accettate (ad esempio da un maestro artigiano o specialista autorizzato), le istruzioni operative sono state rispettate e i prodotti IB Rubinetterie Spa hanno è stato utilizzato in linea con le istruzioni tecniche e di manutenzione fornite da IB Rubinetterie Spa.

Ciò deve includere ma non essere limitato al fatto che i tubi dell'acqua di ingresso siano debitamente lavati, specialmente prima dell'installazione del prodotto o in seguito a misure di costruzione conformi alle norme vigenti, lavori di installazione conformi agli schemi allegati e verifiche condotte sulla conformità del funzionamento pressione nella rete idrica con specifiche tecniche.

Le istruzioni di installazione, uso e manutenzione sono fornite con tutti i prodotti e possono essere trovate su www.ibrubinetterie.it

La garanzia non copre:

- Indossare parti soggette ad usura come guarnizioni;
- Rottura di componenti fragili come vetro o lampadine;
- L'esaurimento di materiali di consumo come batterie, filtri o aeratori;

- Lievi deviazioni dei prodotti IB Rubinetterie Spa dalla qualità target che non pregiudicano l'usabilità del prodotto;
- Pulizia, getti d'acqua, in particolare getti d'acqua calda, depositi di calcare, errori di funzionamento e di manipolazione, danni causati da influenze ambientali aggressive, prodotti chimici o detergenti;
- Difetti del prodotto causati dall'installazione, trasporto o collaudo dell'elemento acquistato;
- Danni causati dal prodotto difettoso IB Rubinetterie Spa;
- Visualizza prodotti e simili.

La garanzia non è valida in caso di:

- Inosservanza delle istruzioni di installazione, manutenzione e utilizzo allegate o fornite su www.ibrubinetterie.it;
- Installazione, manutenzione, riparazione o assistenza da parte di persone non qualificate;
- Danni al prodotto causati dal venditore, dall'idraulico o da terze persone;
- Danni che possono essere attribuiti a normale usura o danno intenzionale - in caso di danno colposo, la negligenza contributiva deve essere compensata su accordo;
- Installazione o messa in servizio errate;
- Manutenzione insufficiente o impropria;
- Prodotti che non sono stati o non sono utilizzati in conformità con lo scopo previsto;
- Danni causati da cause di forza maggiore o disastri naturali, in particolare ma non limitati a inondazioni, incendi o danni da gelo.

Non applicabilità della garanzia

Se un difetto del prodotto non è coperto da questa garanzia, tutti i costi derivanti dalla spedizione e dal trasporto del prodotto sono a carico del consumatore. Il consumatore deve inoltre sostenere tutti i costi, compresi i costi di manodopera, derivanti dall'ispezione del prodotto, nonché i costi di disinstallazione e reinstallazione del prodotto.

Se, essendo stato informato della non applicabilità della garanzia e dei potenziali costi che potrebbero derivare dalle attività di servizio, il consumatore desidera che le attività di manutenzione siano condotte, deve anche sostenere i costi dei pezzi di ricambio e della manodopera.

Qualora il difetto del prodotto non fosse presente alla consegna, IB Rubinetterie Spa deciderà caso per caso se tale difetto possa essere rettificato tramite avviamento. In tali casi, il consumatore non ha alcun diritto legale alla rettifica del difetto.

Diritti legali

Oltre ai diritti derivanti dalla garanzia, il consumatore ha anche diritto ai diritti legali. Questi diritti a volte minori per il consumatore non devono essere limitati dalla garanzia. La garanzia non pregiudica inoltre i diritti del cliente principale e, se del caso, del consumatore in relazione al venditore presso il quale il cliente principale ha acquistato il prodotto.

Luogo di adempimento, luogo di giurisdizione e leggi applicabili

Tale garanzia sarà soggetta alla legge italiana con l'esclusione della Convenzione delle Nazioni Unite sui contratti di vendita internazionale di merci (CISG) dell'11 aprile 1980. Il luogo di adempimento per gli obblighi derivanti dalla presente garanzia sarà Brescia, Italia. Ove consentito, il foro competente è Brescia, Italia.





RACCOMANDAZIONE DI PULIZIA IB RUBINETTI

Oggi i moderni prodotti come rubinetteria sanitaria, rubinetteria da cucina, docce, accessori, lavabi, vasche e radiatori sono costituiti da materiali molto diversi per soddisfare le esigenze del mercato in termini di design e funzionalità. Per evitare danni e reclami, è necessario considerare alcuni criteri durante la pulizia.

Per quanto riguarda la pulizia dei prodotti IB RUBINETTI, è necessario osservare i seguenti punti:

- Utilizzare esclusivamente materiali di pulizia specificatamente previsti per questo tipo di applicazione.
- Non utilizzare mai detersivi che contengono acido cloridrico, acido formico, liscivia a base di cloro o acido acetico, poiché causano danni considerevoli.
- I detersivi acidi al fosforo sono applicabili solo in determinate condizioni.
- La miscelazione di detersivi diversi non è generalmente consentita.
- Non utilizzare mai materiali o apparecchi per la pulizia con un effetto abrasivo, come polveri detersivi non idonei, spugne o panni in microfibra.
- Le istruzioni dei produttori di detersivi devono essere seguite attentamente.
- La pulizia deve essere eseguita con un dosaggio specifico di detersivo per la pulizia, per un tempo limitato adatto, correlato all'oggetto e adattato alle esigenze.
- Il calcare deve essere rimosso regolarmente.
- Quando si usano detersivi spray, spruzzare la soluzione detersiva su un panno morbido o una spugna, mai direttamente sui prodotti IB RUBINETTI, poiché lo spray nebulizzato potrebbe penetrare nelle giunture e negli spazi vuoti del prodotto e causare danni.
- Dopo la pulizia, sciacquare abbondantemente con acqua pulita per rimuovere eventuali residui di detersivo.
- L'uso di pulitori a vapore non è permesso. Le alte temperature possono danneggiare i prodotti.

⚠ Importante

Residui di articoli da toeletta come saponi liquidi, shampoo e gel doccia, tinture per capelli, profumi, dopobarba e smalto possono anch'essi causare danni. Anche qui: risciacquare accuratamente con acqua dopo l'uso per rimuovere i residui. Allo stesso modo, non conservare alcun detersivo o prodotto chimico sotto i prodotti, per esempio negli scompartimenti sotto al lavabo, in quanto i vapori potrebbero danneggiare i prodotti.

I componenti con superfici danneggiate devono essere sostituiti altrimenti potrebbe esserci il rischio di lesioni. I danni causati da un trattamento improprio non sono coperti dalla nostra garanzia.

FRA CONDITIONS DE VENTE

Général

IB Rubinetterie SpA assume la garantie du fabricant à l'égard des consommateurs des produits IB Rubinetterie SpA, en plus de la garantie légale à laquelle le consommateur a droit vis-à-vis du vendeur. Il s'applique sans préjudice des dispositions légales en matière de responsabilité, telles que celles prévues par la loi sur la responsabilité du fait des produits, en cas de faute intentionnelle ou de faute grave, résultant en une perte de la vie, d'une lésion corporelle ou d'un dommage à la santé de IB Rubinetterie SpA ou de ses agents.

Le terme «consommateur» dans la présente garantie du fabricant s'entend de toute personne physique propriétaire du produit qui ne l'a pas acheté à des fins de revente ou d'installation pour un tiers dans le cadre de ses activités professionnelles commerciales ou non salariées. Le terme «client primaire» désigne le consommateur qui a directement acheté le produit à IB Rubinetterie SpA ou à un revendeur ou une autre personne physique ou morale qui revend ou installe le produit dans le cadre de ses activités professionnelles commerciales ou non salariées.

Garantie de protection

Valable pour les produits IB Rubinetterie SpA achetés par les principaux clients à partir du 01/01/2010 (reçu d'achat):

IB Rubinetterie SpA garantit aux consommateurs que ses produits sont exempts de matières, de fabrication et défauts de conception. La science et la technologie les plus récentes au moment de la fabrication sont décisives à cet égard. Le défaut à l'origine du dommage doit déjà être présent dans le produit à ce moment. Demandes de remboursement de dommages indirects ou pour des motifs liés à la responsabilité du produit ne sera valable que conformément aux dispositions légales en vigueur.

Cette garantie est valable cinq ans à compter de la date d'achat par le client principal et au maximum six ans à compter de la date de fabrication. La période de garantie ne doit pas être prolongée en raison de la fourniture de services entrant dans le cadre de la présente garantie, notamment en cas d'entretien ou de remplacement. Dans ce cas, la période de garantie ne doit pas non plus recommencer.

Notification écrite des défauts

Le consommateur a le droit de tirer parti des droits de cette garantie en fournissant à IB Rubinetterie SpA ou au revendeur auprès duquel le client principal a acheté le produit un avis écrit du défaut dans le délai de garantie. Le consommateur doit également notifier le défaut dans les deux mois suivant sa détection ou le moment où sa détection doit avoir été possible. Le consommateur est tenu de prouver que la garantie n'a pas expiré (par exemple, en présentant le reçu d'achat du client principal).

IB Rubinetterie SpA est également habilitée à déterminer le début de la période de garantie sur la base des données de fabrication.

Services en cas de réclamation de garantie

IB Rubinetterie SpA est habilitée à réparer ou à remplacer le produit, ou à rembourser le prix d'achat au consommateur.

En règle générale, le consommateur fait réparer le produit défectueux par un spécialiste, avec l'accord préalable de IB Rubinetterie SpA. Dans ce cas, la garantie couvre la livraison gratuite des pièces de rechange nécessaires. Si IB Rubinetterie SpA publie une décision écrite concernant la maintenance elle-même, IB Rubinetterie SpA supportera tous les frais occasionnés par les pièces de rechange, l'installation et la main-d'œuvre, ainsi que les frais occasionnés par le transport ou l'envoi du produit. Le consommateur doit donner accès au produit.

En cas de remplacement, l'ancien produit doit être remplacé par un nouveau produit du même type, de la même valeur et du même type. Si le produit en question n'est plus fabriqué au moment

où le défaut est signalé, IB Rubinetterie SpA est autorisée à fournir un produit similaire. Le transport ou l'expédition vers et depuis IB Rubinetterie SpA ou vers et depuis le revendeur, toute désinstallation et réinstallation du produit ou toute autre mesure particulière ne peuvent être effectués qu'avec l'accord préalable de IB Rubinetterie SpA. Si IB Rubinetterie SpA accepte la mesure envisagée, IB Rubinetterie SpA assumera les coûts découlant de la mesure. Sauf convention contraire, le consommateur s'engage à retirer ce nouveau produit auprès du revendeur IB Rubinetterie SpA le plus proche.

Si IB Rubinetterie SpA choisit de rembourser le prix d'achat et le confirme par écrit, le consommateur retournera le produit et IB Rubinetterie SpA remboursera le prix d'achat payé.

Conditions et exclusions

Cette garantie n'est valable que si l'installation et la maintenance ont été dûment effectuées conformément aux instructions d'utilisation et aux pratiques techniques généralement acceptées (par exemple par un maître-artisan ou un spécialiste agréé), si les instructions d'utilisation ont été respectées et si les produits IB Rubinetterie SpA ont été utilisés conformément aux instructions techniques et de maintenance fournies par IB Rubinetterie SpA.

Cela inclut, sans toutefois s'y limiter, que les tuyaux d'arrivée d'eau soient dûment rincés, en particulier avant l'installation du produit ou après les mesures de construction conformément aux normes en vigueur, des travaux d'installation conformes aux schémas annexés et des contrôles en cours sur la conformité des conditions de travail pression dans les conduites d'eau avec spécifications techniques.

Les instructions d'installation, d'utilisation et de maintenance sont fournies avec tous les produits et peuvent être consultées sur www.ibrubinetterie.it

La garantie ne couvre pas:

- les pièces d'usure telles que les joints d'étanchéité;
- rupture de composants fragiles tels que le verre ou les ampoules;
- l'épuisement des matériaux consommables tels que les piles, les filtres ou les aérateurs;
- Légères déviations des produits IB Rubinetterie SpA par rapport à la qualité cible n'affectant pas la facilité d'utilisation du produit;
- nettoyage, jets d'eau, en particulier jets d'eau chaude, dépôts de calcaire, erreurs de fonctionnement et de manipulation, dommages causés par des influences environnementales agressives, produits chimiques ou détergents;
- les défauts du produit causés par l'installation, le transport ou le test de fonctionnement de l'article acheté;
- Dommages causés par le produit IB Rubinetterie SpA défectueux;
- Afficher les produits et similaires.

La garantie ne sera pas valable en cas de:

- Non-respect des instructions d'installation, de maintenance et d'utilisation annexées ou fournies sur le site www.ibrubinetterie.it;
- installation, maintenance, réparation ou entretien par des personnes non qualifiées;
- les dommages au produit causés par le vendeur, le plombier ou des tiers;
- Dommages pouvant être attribués à l'usure normale ou intentionnelle - en cas de dommage par négligence, la négligence contributive est compensée par accord;



- mauvaise installation ou mise en service;
- entretien insuffisant ou inapproprié;
- les produits qui n'ont pas été utilisés ou ne sont pas utilisés conformément à leur destination;
- Dommages causés par des cas de force majeure ou des catastrophes naturelles, notamment des inondations, des incendies ou des dégâts dus au gel.

Non-applicabilité de la garantie

Si un défaut de produit n'est pas couvert par cette garantie, tous les frais occasionnés par l'expédition et le transport du produit sont à la charge du consommateur. Le consommateur doit également supporter tous les coûts, y compris les coûts de main-d'œuvre, résultant de l'inspection du produit, ainsi que les coûts de désinstallation et de réinstallation du produit.

Si, après avoir été informé de la non-applicabilité de la garantie et des coûts potentiels pouvant découler des activités de maintenance, le consommateur souhaite que les activités de maintenance soient menées, il doit également supporter les coûts des pièces de rechange et de la main-d'œuvre.

Si le défaut du produit n'était pas présent à la livraison, IB Rubinetteria SpA décidera au cas par cas si ledit défaut peut être corrigé par le biais de l'achalandage. Dans ce cas, le consommateur n'a légalement aucun droit à la rectification du défaut.

Droits légaux

En plus des droits découlant de la garantie, le consommateur a également droit à des droits légaux. Ces droits parfois moindres pour le consommateur ne sont pas limités par la garantie. La garantie ne porte pas non plus atteinte aux droits du client primaire et, le cas échéant, du consommateur vis-à-vis du vendeur auprès duquel le client primaire a acheté le produit.

Lieu d'exécution, lieu d'exécution et lois applicables

La présente garantie est soumise à la loi italienne, à l'exclusion de la Convention des Nations Unies sur les contrats de vente internationale de marchandises (CVIM) du 11 avril 1980. Le lieu d'exécution des obligations découlant de cette garantie est Brescia, Italie. Le cas échéant, le lieu de juridiction sera Brescia, Italie.



RECOMMANDATION DE NETTOYAGE IB RUBINETTI

Aujourd'hui, les robinetteries sanitaires et de cuisine modernes, les douches, les accessoires, les lavabos, les cuves et les radiateurs sont constitués de matériaux très différents pour répondre aux besoins du marché en termes de conception et de fonctionnalité. Pour éviter tout dommage et toute prétention, lors du nettoyage.

En ce qui concerne le nettoyage des produits IB RUBINETTI, les points suivants doivent être respectés:

- Utilisez uniquement du matériel de nettoyage explicitement fourni pour ce type d'application.
- N'utilisez jamais de produits de nettoyage contenant de l'acide chlorhydrique, de l'acide formique, de la lessive de blanchiment chlorée ou de l'acide acétique, car ils causent des dégâts considérables.
- Les nettoyeurs acides au phosphore ne sont applicables que dans certaines conditions.
- Le mélange de différents agents de nettoyage n'est généralement pas autorisé.
- N'utilisez jamais de produits de nettoyage ou d'appareils ayant un effet abrasif, tels que poudres de nettoyage inappropriées, tampons éponges ou chiffons en microfibre.
- Les instructions des fabricants d'agents de nettoyage doivent être suivies à la lettre.
- Le nettoyage doit être effectué avec un dosage spécifié de détergent de nettoyage, pendant une durée appropriée, liée à l'objet et adaptée aux besoins.
- Le calcaire doit être enlevé en le nettoyant régulièrement.
- Lorsque vous utilisez des nettoyeurs en spray, vaporisez la solution de nettoyage sur un chiffon doux ou une éponge, jamais directement sur les produits IB RUBINETTI, car le spray atomisé pourrait pénétrer dans les ouvertures et les fentes du produit et causer des dommages.
- Après le nettoyage, rincez abondamment à l'eau claire pour éliminer tout résidu de nettoyage.
- L'utilisation de nettoyeurs à vapeur n'est pas autorisée. Les températures élevées peuvent endommager les produits.

Important

Les résidus d'articles de toilette, tels que les savons liquides, les shampooings et les gels pour la douche, les teintures pour les cheveux, les parfums, les lotions après-rasage et les vernis à ongles peuvent également causer des dommages. Ici aussi: après l'utilisation, rincez soigneusement à l'eau pour éliminer les résidus. De même, ne stockez pas d'agents de nettoyage ou de produits chimiques sous les produits, par exemple dans une coiffeuse, car les vapeurs peuvent endommager les produits.

Les composants dont les surfaces sont endommagées doivent être remplacés afin d'éviter tout risque de blessure. Les dommages causés par un traitement inapproprié ne sont pas couverts par notre garantie.



Join us and find all information on products of IB Rubinetti from the site www.ibrubinetti.it

Seguici e trova tutte le informazioni sui prodotti IB Rubinetti dal sito www.ibrubinetti.it

Rejoignez-nous et trouvez toutes les informations sur les produits de IB Rubinetti sur le site www.ibrubinetti.it

IB RUBINETTERIE s.p.a
via dei Pianotti 3/5
25068 Sarezzo (BS) - Italy -
phone +39 030 802101
fax +39 030 803097
info@ibrubinetterie.it
www.ibrubinetti.it



Credits:

Art Direction and Graphic
Federico Castelli Design

Photography
Pierpaolo Romano
Ottavio Tomasini

Print
COLOR ART

Thanks to:
Ceramica Flaminia
Ceramica GLOBO
Simas
Falper
Cerasa
14Oraitaliana





IB RUBINETTI